

Apacer

The Most **Reliable**
Storage For Industries

SH250-CFast



SH250-CFast

Overview

Apacer SH250-CFast 2.0 is the latest enhancement of conventional CFast form factor that delivers various technological advantages. It utilizes 3D NAND for higher capacity up to 160GB and provides more power efficiency than 2D NAND. This new flash memory card comes with SATA 6.0 Gbps interface for higher performance and consists of SATA-based 7-pin signal segment and 17-pin for power and control purposes. Designed without DRAM on the internal controlling unit, SH250-CFast ensures data integrity by preventing data loss during a sudden power outage.



For data efficiency, SH250-CFast 2.0 delivers data transfer rates up to 560MB/s in sequential access and 66,000 IOPS in 4KB random access. In addition, Apacer CFast cards come with S.M.A.R.T. for lifetime monitoring. With Apacer's SLC-liteX technology, SH250-CFast 2.0 performs with higher number of P/E cycles up to 30,000 times. Moreover, SH250-CFast 2.0 guarantees reliability of applications in harsh environments by implementing intelligent Flash Management algorithms and LDPC (Low Density Parity Check) ECC engine to extend SSD endurance and increase data reliability.

*The actual available memory on the device is less than what is listed on the package. This is due to small discrepancies in file formats and algorithms used by various operating systems. In addition, a portion of memory space is reserved for system files and data sectors for better performance.

Feature

- Low-Density Parity-Check (LDPC) Code
- Global Wear Leveling
- Flash bad-block management
- Flash Translation Layer: Page Mapping
- DataDefender™
- S.M.A.R.T.
- Devslp
- ATA Secure Erase
- TRIM
- Hyper Cache Technology
- Over-Provisioning
- SMART Read Refresh™
- SLC-liteX

Specifications

Model	SH250-CFast
Interface	SATA 3.2 (6Gb/s)
Connector	(7+17) pin male
Form Factor	CFast
NAND Flash Type	3D TLC
Capacity	10GB ~ 160GB
External DRAM	No
Sustained Read Performance (MB/sec)	Up to 560
Sustained Write Performance (MB/sec)	Up to 515
ECC Engine	Low-Density Parity-Check (LDPC) Code
IOPs (4K Random Write)	72K
Standard Operating Temperature (°C)	0 ~ + 70
Extended Operating Temperature (°C)	-40 ~ + 85
Storage Temperature (°C)	-40 ~ + 100
Housing	Yes
H/W Write Protect	No
Screw Hole	No
Cable-less Solution	No
Thermal Sensor	Yes
Shock	Operation: 50G, 11ms Non-operation: 1500G, 0.5ms
Vibration	Operation: 7.69 Grms, 20~2000 Hz/random (compliant with MIL-STD-810G) Non-operation: 4.02 Grms, 15 ~ 2000 Hz/sine (compliant with MIL-STD-810G)
Operating Voltage	3.3 V / 5.0 V ± 5%
Power Consumption	Active mode: 395 mA / Idle mode: 75 mA
Dimension (L x W x H)	36.4 x 42.8 x 3.6 mm
MTBF (hours)	>3,000,000

Mechanical Specification

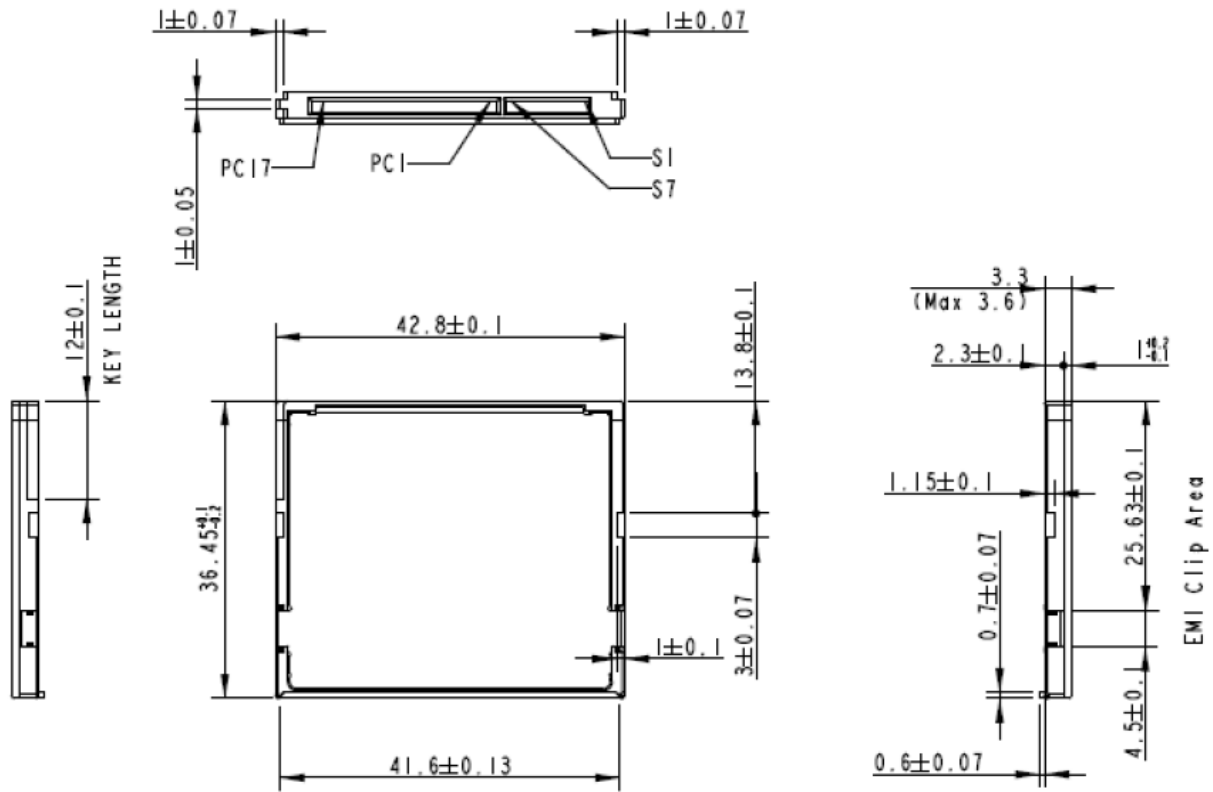

Unit: mm

For more information,
contact your Apacer representative

Global Presence

Taiwan (Headquarters)
Apacer Technology Inc.
Tel: +886-2-2267-8000
Fax: +886-2-2267-2261

Europe
Apacer Technology B.V.
Tel: +31-40-267-0000
Fax: +31-40-290-0686

U.S.A.
Apacer Memory America, Inc.
Tel: +1-408-518-8699
Fax: 1-510-249-9551

China
Apacer Electronic(Shanghai)
Co., Ltd.
Tel: +86-21-6228-9939

Japan
Apacer Technology Corp.
Tel: +81-3-5419-2668
Fax: +81-3-5419-0018

India
Apacer Technologies Pvt. Ltd.
Tel: +91-80-41529061~3
Fax: +91-80-41700215