

YSD60L SERIES 40W









yingjiao's slimline power family are designed with slim plastic housing and for full range AC input from 90VAC to 264VAC.

The series are single phase Psu, providing DC Ok relay contact and adjustable DC output voltage. They have high efficiency and operate in wide temperature range.

The series can widely used for industrial automation & control systems, varied equipments etc.



Features

-  universal AC Input/ Full Range
-  Installation on DIN Rail TS-35/7.5 & 15
-  DC oK Relay Contact
-  DC output voltage Adjustable
-  protection: Short Circuit/overload/over voltage
-  Isolation Class
-  Three years warranty

Model Information

yingjiao Part number	DC VOLTAGE	RATED CURRENT	RATED POWER
YSD60L-05006000	5V	6A	30W
YSD60L-12003330	12V	3.33A	40W
YSD60L-24001700	24V	1.7A	40W
YSD60L-48000830	48V	0.83A	40W

Input

VOLTAGE RANGE	90-264VAC/127-370VDC	
FREQUENCY RANGE	47~63Hz	
INRUSH CURRENT	30A/115VAC Cold start 60A/230VAC Cold start	
AC CURRENT	1.1A/115VAC 0.7A/230VAC	
LEAKAGE CURRENT	<1mA/240VAC	
EFFICIENCY	78%	YSD60L-05006000
	86%	YSD60L-12003330
	88%	YSD60L-24001700
	88%	YSD60L-48000830

Output

RIPPLE & NOISE	80mVp-p	YSD60L-05006000
	120mVp-p	YSD60L-12003330
	150mVp-p	YSD60L-24001700
	200mVp-p	YSD60L-48000830
VOLTAGE ADJ. RANGE	5~6V	YSD60L-05006000
	12~15V	YSD60L-12003330
	24~30V	YSD60L-24001700
	43.2~52.8V	YSD60L-48000830

output

VOLTAGE TOLERANCE	±2.0%
LINE REGULATION	±2.0%
LOAD REGULATION	±5.0%
SETUP, RISE TIME	500ms, 30ms/230VAC at full load 500ms, 30ms/115VAC at full load
HOLD UPTIME (TYP.)	50ms/230VAC at full load 20ms/115VAC at full load

protection

OVER LOAD	105%-150% Rated Output Power Protection type: Constant current limiting- recovers automatically after fault condition is removed.
OVERVOLTAGE	5V:6.25~ 7.25V 12V:15.6 ~ 18V 24V:31.2 ~ 36V 48V:57.6 ~64.8V Protection type : Shutdown o/p voltage, re-power on to recover

Environment

OPERATING TEMPERATURE	-20 °C to 70 °C(Refer to "Derating Curve")
STORAGE TEMP	-40 °C to 85 °C
STORAGE HUMIDITY	10 ~ 95% RH
WORKING HUMIDITY	20% ~ 90% RH Non-Condensing

SAFETY & EMC

SAFETY STANDARDS	UL508 , BS/EN62368-1 approved
WITHSTAND VOLTAGE	I/P-O/P:3KVAC I/P-FG:2KVAC O/P-FG:0.5KVAC
ISOLATION RESISTANCE	I/P-O/P, I/P-FG, O/P-FG:>100M Ohms / 500VDC / 25°C/ 70% RH
EMC EMISSION	BS EN/EN 55032 class B, BS EN/EN IEC 61000-3-2,3
EMC IMMUNITY	BS EN/EN61000-4-2,3,4,5,6,8,11

Dimensions & weight

Length:	41mm / 1.61in
width:	100mm / 3.94in
Height:	92mm / 3.62in
weight:	280g

packing

carton size:	54 X 24.5 X 24 CM 21.26 X 9.65 X 9.45 in
Master carton Quantities:	50pcs / Carton

Dimensions and Installation

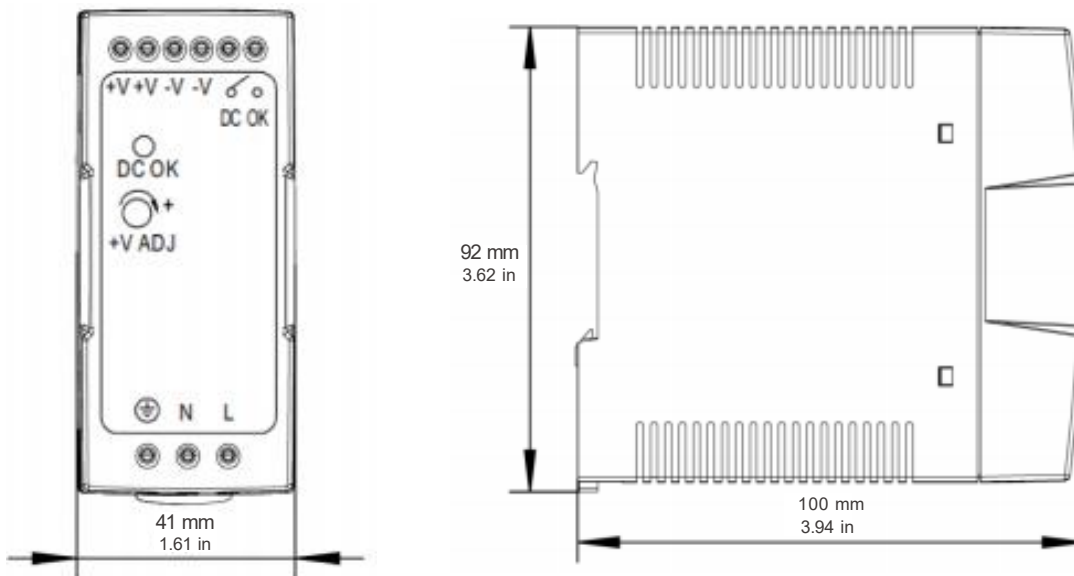

Functional Diagram

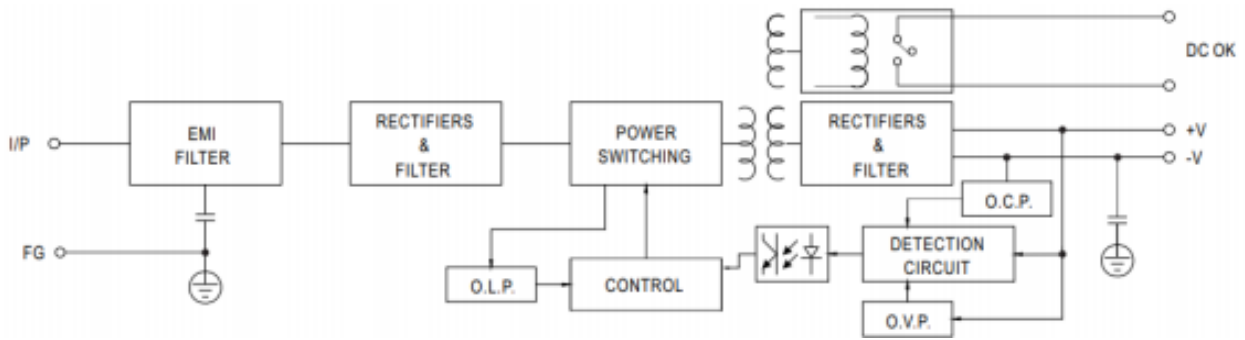

APPLication Of DC OK Active signal

Contact Close	PSU turns on / DC OK.
Contact Open	PSU turns off / DC Fail.
Contact Ratings (max.)	30V/1A resistive load.

Deduction Curve and TemPerature

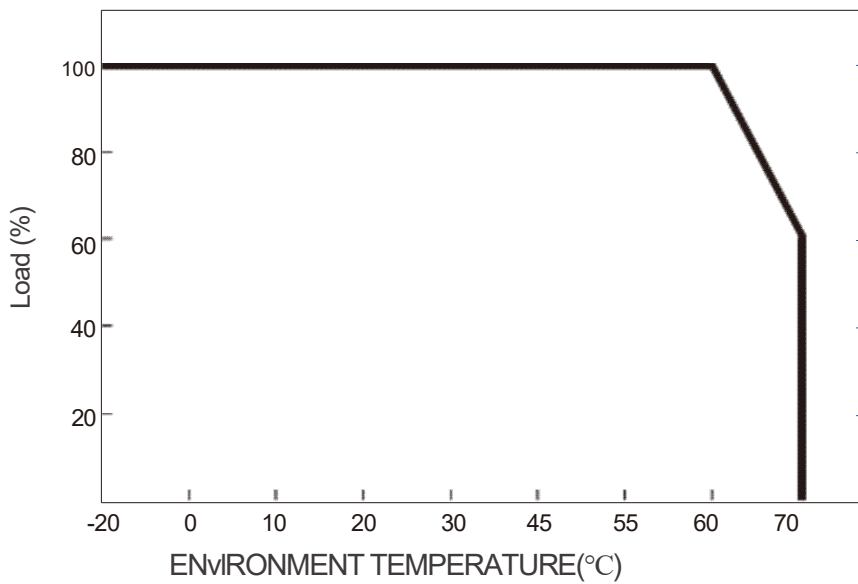

Minus Output and Input Voltage Curves

