



**HIRSCHMANN**

A **BELDEN** BRAND

Hirschmann Automation and Control GmbH

# RSPE HiOS-2S Rel. 08600

**Reference Manual**

Graphical User Interface

**User Manual**

Configuration



**HIRSCHMANN**

A **BELDEN** BRAND

# Reference Manual

## Graphical User Interface Rail Switch Power Enhanced HiOS-2S

The naming of copyrighted trademarks in this manual, even when not specially indicated, should not be taken to mean that these names may be considered as free in the sense of the trademark and tradename protection law and hence that they may be freely used by anyone.

© 2020 Hirschmann Automation and Control GmbH

Manuals and software are protected by copyright. All rights reserved. The copying, reproduction, translation, conversion into any electronic medium or machine scannable form is not permitted, either in whole or in part. An exception is the preparation of a backup copy of the software for your own use.

The performance features described here are binding only if they have been expressly agreed when the contract was made. This document was produced by Hirschmann Automation and Control GmbH according to the best of the company's knowledge. Hirschmann reserves the right to change the contents of this document without prior notice. Hirschmann can give no guarantee in respect of the correctness or accuracy of the information in this document.

Hirschmann can accept no responsibility for damages, resulting from the use of the network components or the associated operating software. In addition, we refer to the conditions of use specified in the license contract.

You can get the latest version of this manual on the Internet at the Hirschmann product site ([www.hirschmann.com](http://www.hirschmann.com)).

Hirschmann Automation and Control GmbH  
Stuttgarter Str. 45-51  
72654 Neckartenzlingen  
Germany

## Contents

	<b>Safety instructions</b> .....	7
	<b>About this Manual</b> .....	9
	<b>Key</b> .....	10
	<b>Notes on the Graphical User Interface</b> .....	11
<b>1</b>	<b>Basic Settings</b> .....	17
1.1	System .....	17
1.2	Modules .....	23
1.3	Network .....	25
1.3.1	Global .....	26
1.3.2	IPv4 .....	29
1.4	Software .....	31
1.5	Load/Save .....	34
1.6	External Memory .....	45
1.7	Port .....	49
1.8	Power over Ethernet .....	56
1.8.1	PoE Global .....	57
1.8.2	PoE Port .....	60
1.9	Restart .....	63
<b>2</b>	<b>Time</b> .....	67
2.1	Basic Settings .....	67
2.2	SNTP .....	71
2.2.1	SNTP Client .....	72
2.2.2	SNTP Server .....	76
2.3	PTP .....	78
2.3.1	PTP Global .....	79
2.3.2	PTP Boundary Clock .....	81
2.3.2.1	PTP Boundary Clock Global .....	82
2.3.2.2	PTP Boundary Clock Port .....	87
2.3.3	PTP Transparent Clock .....	91
2.3.3.1	PTP Transparent Clock Global .....	92
2.3.3.2	PTP Transparent Clock Port .....	96
2.4	802.1AS .....	97
2.4.1	802.1AS Global .....	98
2.4.2	802.1AS Port .....	102
2.4.3	802.1AS Statistics .....	107
<b>3</b>	<b>Device Security</b> .....	109
3.1	User Management .....	109
3.2	Authentication List .....	115
3.3	Management Access .....	118
3.3.1	Server .....	119
3.3.2	IP Access Restriction .....	133

3.3.3	Web .....	137
3.3.4	Command Line Interface .....	138
3.3.5	SNMPv1/v2 Community .....	141
3.4	Pre-login Banner .....	142
<b>4</b>	<b>Network Security</b> .....	<b>145</b>
4.1	Network Security Overview .....	145
4.2	Port Security .....	147
4.3	802.1X Port Authentication .....	152
4.3.1	802.1X Global .....	153
4.3.2	802.1X Port Configuration .....	155
4.3.3	802.1X Port Clients .....	160
4.3.4	802.1X EAPOL Port Statistics .....	162
4.3.5	802.1X Port Authentication History .....	164
4.3.6	802.1X Integrated Authentication Server .....	166
4.4	RADIUS .....	167
4.4.1	RADIUS Global .....	168
4.4.2	RADIUS Authentication Server .....	170
4.4.3	RADIUS Accounting Server .....	172
4.4.4	RADIUS Authentication Statistics .....	174
4.4.5	RADIUS Accounting Statistics .....	176
4.5	DoS .....	177
4.5.1	DoS Global .....	178
4.6	ACL .....	181
4.6.1	ACL IPv4 Rule .....	183
4.6.2	ACL MAC Rule .....	186
4.6.3	ACL Assignment .....	189
<b>5</b>	<b>Switching</b> .....	<b>191</b>
5.1	Switching Global .....	191
5.2	Rate Limiter .....	194
5.3	Filter for MAC Addresses .....	197
5.4	IGMP Snooping .....	199
5.4.1	IGMP Snooping Global .....	200
5.4.2	IGMP Snooping Configuration .....	202
5.4.3	IGMP Snooping Enhancements .....	206
5.4.4	IGMP Snooping Querier .....	209
5.4.5	IGMP Snooping Multicasts .....	212
5.5	Time-Sensitive Networking .....	213
5.5.1	TSN Configuration .....	214
5.5.2	TSN Service Data Unit .....	218
5.5.3	TSN Gate Control List .....	219
5.5.3.1	TSN Configured Gate Control List .....	220
5.5.3.2	TSN Current Gate Control List .....	222
5.6	MRP-IEEE .....	223
5.6.1	MRP-IEEE Configuration .....	224
5.6.2	MRP-IEEE Multiple MAC Registration Protocol .....	225
5.6.3	MRP-IEEE Multiple VLAN Registration Protocol .....	230

5.7	QoS/Priority	233
5.7.1	QoS/Priority Global	234
5.7.2	QoS/Priority Port Configuration	235
5.7.3	802.1D/p Mapping	237
5.7.4	IP DSCP Mapping	239
5.7.5	Queue Management	241
5.8	VLAN	242
5.8.1	VLAN Global	244
5.8.2	VLAN Configuration	245
5.8.3	VLAN Port	247
5.8.4	VLAN Voice	249
5.9	L2-Redundancy	251
5.9.1	MRP	252
5.9.2	DLR (depends on hardware)	256
5.9.2.1	DLR Configuration (depends on hardware)	258
5.9.2.2	DLR Statistics (depends on hardware)	262
5.9.3	PRP (depends on hardware)	265
5.9.3.1	PRP Configuration (depends on hardware)	266
5.9.3.2	PRP DAN/VDAN Table (depends on hardware)	269
5.9.3.3	PRP Proxy Node Table (depends on hardware)	270
5.9.3.4	PRP Statistics (depends on hardware)	271
5.9.4	HSR (depends on hardware)	272
5.9.4.1	HSR Configuration (depends on hardware)	273
5.9.4.2	HSR DAN/VDAN Table (depends on hardware)	277
5.9.4.3	HSR Proxy Node Table (depends on hardware)	278
5.9.4.4	HSR Statistics (depends on hardware)	279
5.9.5	Spanning Tree	280
5.9.5.1	Spanning Tree Global	281
5.9.5.2	Spanning Tree Port	287
5.9.6	Link Aggregation	294
5.9.7	Link Backup	301
<b>6</b>	<b>Diagnostics</b>	<b>305</b>
6.1	Status Configuration	305
6.1.1	Device Status	306
6.1.2	Security Status	311
6.1.3	Signal Contact	318
6.1.3.1	Signal Contact 1 / Signal Contact 2	319
6.1.4	MAC Notification	324
6.1.5	Alarms (Traps)	326
6.2	System	328
6.2.1	System Information	329
6.2.2	Hardware State	330
6.2.3	Configuration Check	331
6.2.4	IP Address Conflict Detection	333
6.2.5	ARP	337
6.2.6	Selftest	338

6.3	Syslog .....	341
6.4	Ports .....	344
6.4.1	SFP .....	345
6.4.2	TP cable diagnosis .....	347
6.4.3	Port Monitor .....	349
6.4.4	Auto-Disable .....	360
6.4.5	Port Mirroring .....	363
6.5	LLDP .....	365
6.5.1	LLDP Configuration .....	366
6.5.2	LLDP Topology Discovery .....	370
6.6	Report .....	373
6.6.1	Report Global .....	374
6.6.2	Persistent Logging .....	379
6.6.3	System Log .....	382
6.6.4	Audit Trail .....	383
<b>7</b>	<b>Advanced</b> .....	<b>385</b>
7.1	DHCP L2 Relay .....	385
7.1.1	DHCP L2 Relay Configuration .....	386
7.1.2	DHCP L2 Relay Statistics .....	389
7.2	DHCP Server .....	390
7.2.1	DHCP Server Global .....	391
7.2.2	DHCP Server Pool .....	392
7.2.3	DHCP Server Lease Table .....	397
7.3	Industrial Protocols .....	398
7.3.1	IEC61850-MMS .....	399
7.3.2	Modbus TCP .....	402
7.3.3	PROFINET .....	404
7.3.4	EtherNet/IP .....	407
7.4	Command Line Interface .....	408
<b>A</b>	<b>Index</b> .....	<b>409</b>
<b>B</b>	<b>Further support</b> .....	<b>415</b>
<b>C</b>	<b>Readers' Comments</b> .....	<b>416</b>

## Safety instructions

### **WARNING**

#### **UNCONTROLLED MACHINE ACTIONS**

To avoid uncontrolled machine actions caused by data loss, configure all the data transmission devices individually.

Before you start any machine which is controlled via data transmission, be sure to complete the configuration of all data transmission devices.

**Failure to follow these instructions can result in death, serious injury, or equipment damage.**





---

## About this Manual

The “Configuration” user manual contains the information you need to start operating the device. It takes you step by step from the first startup operation through to the basic settings for operation in your environment.

The “Installation” user manual contains a device description, safety instructions, a description of the display, and the other information that you need to install the device.

The “Graphical User Interface” reference manual contains detailed information on using the graphical user interface to operate the individual functions of the device.

The “Command Line Interface” reference manual contains detailed information on using the Command Line Interface to operate the individual functions of the device.

The Industrial HiVision Network Management software provides you with additional options for smooth configuration and monitoring:

- ▶ Auto-topology discovery
- ▶ Browser interface
- ▶ Client/server structure
- ▶ Event handling
- ▶ Event log
- ▶ Simultaneous configuration of multiple devices
- ▶ Graphical user interface with network layout
- ▶ SNMP/OPC gateway

## Key

The designations used in this manual have the following meanings:

▶	List
□	Work step
<a href="#">Link</a>	Cross-reference with link
<b>Note:</b>	A note emphasizes a significant fact or draws your attention to a dependency.
<code>Courier</code>	Representation of a CLI command or field contents in the graphical user interface

 Execution in the Graphical User Interface

 Execution in the Command Line Interface

## Notes on the Graphical User Interface

The Graphical User Interface of the device is divided as follows:

- ▶ [Navigation area](#)
- ▶ [Dialog area](#)
- ▶ [Buttons](#)

### Navigation area

The Navigation area is located on the left side of the Graphical User Interface.

The Navigation area contains the following elements:

- ▶ [Toolbar](#)
- ▶ [Filter](#)
- ▶ [Menu](#)

You have the option of collapsing the entire Navigation area, for example when displaying the Graphical User Interface on small screens. To collapse or expand, you click the small arrow at the top of the navigation area.

### Toolbar

The toolbar at the top of the navigation area contains several buttons.

- When you position the mouse pointer over a button, a tooltip displays further information.
- If the connection to the device is lost, then the toolbar is grayed out.



The device automatically refreshes the toolbar information every 5 seconds.

Clicking the button refreshes the toolbar manually.



When you position the mouse pointer over the button, a tooltip displays the following information:

- ▶ [User:](#)  
Name of the logged in user
- ▶ [Device name:](#)  
Name of the device

Clicking the button opens the [Device Security > User Management](#) dialog.



When you position the mouse pointer over the button, a tooltip displays the summary of the [Diagnostics > System > Configuration Check](#) dialog.

Clicking the button opens the [Diagnostics > System > Configuration Check](#) dialog.



Clicking the button logs out the current user and displays the login dialog.



Displays the remaining time in seconds until the device automatically logs out an inactive user.

Clicking the button opens the *Device Security > Management Access > Web* dialog. There you can specify the timeout.



When the configuration profile in the volatile memory (*RAM*) differs from the "Selected" configuration profile in the non-volatile memory (*NVM*), this button is visible. Otherwise, the button is hidden.

Clicking the button opens the *Basic Settings > Load/Save* dialog.

By right-clicking the button you can save the current settings in the non-volatile memory (*NVM*).



When you position the mouse pointer over the button, a tooltip displays the following information:

- ▶ *Device Status*: This section displays a compressed view of the *Device status* frame in the *Basic Settings > System* dialog. The section displays the alarm that is currently active and whose occurrence was recorded first.
- ▶ *Security Status*: This section displays a compressed view of the *Security status* frame in the *Basic Settings > System* dialog. The section displays the alarm that is currently active and whose occurrence was recorded first.
- ▶ *Boot Parameter*: If you permanently save changes to the settings and at least one boot parameter differs from the configuration profile used during the last restart, then this section displays a note.

The following settings cause the boot parameters to change:

- *Basic Settings > External Memory* dialog, *Software auto update* parameter
- *Basic Settings > External Memory* dialog, *Config priority* parameter
- *Device Security > Management Access > Server* dialog, *SNMP* tab, *UDP port* parameter
- *Diagnostics > System > Selftest* dialog, *RAM test* parameter
- *Diagnostics > System > Selftest* dialog, *SysMon1 is available* parameter
- *Diagnostics > System > Selftest* dialog, *Load default config on error* parameter

Clicking the button opens the *Diagnostics > Status Configuration > Device Status* dialog.

### Filter

The filter enables you to reduce the number of menu items in the menu. When filtering, the menu displays only menu items matching the search string entered in the filter field.

### Menu

The menu displays the menu items.

You have the option of filtering the menu items. See section "Filter".

To display the corresponding dialog in the dialog area, you click the desired menu item. If the selected menu item is a node containing sub-items, then the node expands or collapses while clicking. The dialog area keeps the previously displayed dialog.

You have the option of expanding or collapsing every node in the menu at the same time. When you right-click anywhere in the menu, a context menu displays the following entries:

- ▶ [Expand](#)  
Expands every node in the menu at the same time. The menu displays the menu items for every level.
- ▶ [Collapse](#)  
Collapses every node in the menu at the same time. The menu displays the top level menu items.

## Dialog area

The Dialog area is located on the right side of the Graphical User Interface. When you click a menu item in the Navigation area, the Dialog area displays the corresponding dialog.

## Updating the display

If a dialog remains opened for a longer time, then the values in the device have possibly changed in the meantime.



- To update the display in the dialog, click the  button. Unsaved information in the dialog is lost.

## Saving the settings

Saving, transfers the changed settings to the volatile memory (*RAM*) of the device. Perform the following step:

- Click the  button.

To keep the changed settings, even after restarting the device, perform the following steps:

- Open the [Basic Settings > Load/Save](#) dialog.
- In the table highlight the desired configuration profile.
- When in the [Selected](#) column the checkbox is *unmarked*, click the  button and then the [Select](#) item.
- Click the  button and then the [Save](#) item.

**Note:** Unintentional changes to the settings can terminate the connection between your PC and the device. To keep the device accessible, enable the [Undo configuration modifications](#) function in the [Basic Settings > Load/Save](#) dialog, before changing any settings. Using the function, the device continuously checks if it can still be reached from the IP address of your PC. If the connection is lost, then the device loads the configuration profile saved in the non-volatile memory (*NVM*) after the specified time. Afterwards, the device can be accessed again.

## Working with tables

The dialogs display numerous settings in table form.

When you modify a table cell, the table cell displays a red mark in its top-left corner. The red mark indicates that your modifications are not yet transferred to the volatile memory (*RAM*) of the device.

You have the option of customizing the look of the tables to fit your needs. When you position the mouse pointer over a column header, the column header displays a drop-down list button. When you click this button, the drop-down list displays the following entries:

- ▶ Sort ascending  
Sorts the table entries in ascending order based on the entries of the selected column.  
You recognize sorted table entries by an arrow in the column header.
- ▶ Sort descending  
Sorts the table entries in descending order based on the entries of the selected column.  
You recognize sorted table entries by an arrow in the column header.
- ▶ Columns  
Displays or hides columns.  
You recognize hidden columns by an unmarked checkbox in the drop-down list.
- ▶ Filters  
The table only displays the entries whose content matches the specified filter criteria of the selected column.  
You recognize filtered table entries by an emphasized column header.

You have the option of selecting multiple table entries simultaneously and subsequently applying an action to them. This is useful when you are going to remove multiple table entries at the same time.



- ▶ Select several consecutive table entries:
  - Click the first desired table entry to highlight it.
  - Press and hold the <SHIFT> key.
  - Click the last desired table entry to highlight every desired table entry.
- ▶ Select multiple individual table entries:
  - Click the first desired table entry to highlight it.
  - Press and hold the <CTRL> key.
  - Click the next desired table entry to highlight it.  
Repeat until every desired table entry is highlighted.

## Buttons

Here you find the description of the standard buttons. The special dialog-specific buttons are described in the corresponding dialog help text.



Transfers the changes to the volatile memory (*RAM*) of the device and applies them to the device. To save the changes in the non-volatile memory, proceed as follows:

- Open the *Basic Settings > Load/Save* dialog.
- In the table highlight the desired configuration profile.
- When in the *Selected* column the checkbox is *unmarked*, click the  button and then the *Select* item.
- Click the  button to save your current changes.



Updates the fields with the values that are saved in the volatile memory (*RAM*) of the device.



Transfers the settings from the volatile memory (*RAM*) into the configuration profile designated as “Selected” in the non-volatile memory (*NVM*).

When in the *Basic Settings > External Memory* dialog the checkbox in the *Backup config when saving* column is marked, then the device generates a copy of the configuration profile in the external memory.



Displays a submenu with menu items corresponding to the respective dialog.



Opens the *Wizard* dialog.



Adds a new table entry.



Removes the highlighted table entry.



Opens the online help.





# 1 Basic Settings

The menu contains the following dialogs:

- ▶ System
- ▶ Modules
- ▶ Network
- ▶ Software
- ▶ Load/Save
- ▶ External Memory
- ▶ Port
- ▶ Power over Ethernet
- ▶ Restart

## 1.1 System

[Basic Settings > System]

In this dialog you monitor individual operating statuses.

### Device status

The fields in this frame display the device status and inform you about alarms that have occurred. When an alarm currently exists, the frame is highlighted.

You specify the parameters that the device monitors in the [Diagnostics > Status Configuration > Device Status](#) dialog.

**Note:** If you connect only one power supply unit for the supply voltage to a device with a redundant power supply unit, then the device reports an alarm. To help avoid this alarm, you deactivate the monitoring of the missing power supply units in the [Diagnostics > Status Configuration > Device Status](#) dialog.

Alarm counter

Displays the number of currently existing alarms.



When there is at least one currently existing alarm, the icon is visible.

When you position the mouse pointer over the icon, a tooltip displays the cause of the currently existing alarms and the time at which the device triggered the alarm.

If a monitored parameter differs from the desired status, then the device triggers an alarm. The [Diagnostics > Status Configuration > Device Status](#) dialog, [Status](#) tab displays an overview of the alarms.

## Security status

The fields in this frame display the security status and inform you about alarms that have occurred. When an alarm currently exists, the frame is highlighted.

You specify the parameters that the device monitors in the [Diagnostics > Status Configuration > Security Status](#) dialog.

### Alarm counter

Displays the number of currently existing alarms.



When there is at least one currently existing alarm, the icon is visible.

When you position the mouse pointer over the icon, a tooltip displays the cause of the currently existing alarms and the time at which the device triggered the alarm.

If a monitored parameter differs from the desired status, then the device triggers an alarm. The [Diagnostics > Status Configuration > Security Status](#) dialog, [Status](#) tab displays an overview of the alarms.

## Signal contact status

The fields in this frame display the signal contact status and inform you about alarms that have occurred. When an alarm currently exists, the frame is highlighted.

You specify the parameters that the device monitors in the [Diagnostics > Status Configuration > Signal Contact > Signal Contact 1/Signal Contact 2](#) dialog.

### Alarm counter

Displays the number of currently existing alarms.



When there is at least one currently existing alarm, the icon is visible.

When you position the mouse pointer over the icon, a tooltip displays the cause of the currently existing alarms and the time at which the device triggered the alarm.

If a monitored parameter differs from the desired status, then the device triggers an alarm. The [Diagnostics > Status Configuration > Signal Contact > Signal Contact 1/Signal Contact 2](#) dialog, [Status](#) tab displays an overview of the alarms.

## System data

The fields in this frame display operating data and information on the location of the device.

### System name

Specifies the name for which the device is known in the network.

Possible values:

- ▶ Alphanumeric ASCII character string with 0..255 characters  
The following characters are allowed:
  - 0..9
  - a..z
  - A..Z
  - !#\$%&'()\*+,-./:;<=>?@[\\]^\_`{|}~
  - <device name>-<MAC address> (default setting)

When creating HTTPS X.509 certificates, the application generating the certificate uses the specified value as the domain name and common name.

The following functions use the specified value as a host name or FQDN (Fully Qualified Domain Name). For compatibility, it is recommended to use only small letters, since not every system compares the case in the FQDN. Verify that this name is unique in the whole network.

- ▶ DHCP client
- ▶ *Syslog*
- ▶ *IEC61850-MMS*
- ▶ *PROFINET*

**Note:** For compatibility in PROFINET environments, specify the PROFINET device name. In PROFINET the name is limited to a maximum of 240 characters. Do not begin the name with a number. Programs read the device name using SNMP and PROFINET DCP.

### Location

Specifies the location of the device.

Possible values:

- ▶ Alphanumeric ASCII character string with 0..255 characters

### Contact person

Specifies the contact person for this device.

Possible values:

- ▶ Alphanumeric ASCII character string with 0..255 characters

### Device type

Displays the product name of the basic device.

## Basic Settings

[Basic Settings > System]

---

### Power supply 1

#### Power supply 2

Displays the status of the power supply unit on the relevant voltage supply connection.

Possible values:

- ▶ *present*
- ▶ *defective*
- ▶ *not installed*
- ▶ *unknown*

### Uptime

Displays the time that has elapsed since this device was last restarted.

Possible values:

- ▶ Time in the format `day(s), ...h ...m ...s`

### Temperature [°C]

Displays the current temperature in the device in °C.

You activate the monitoring of the temperature thresholds in the [Diagnostics > Status Configuration > Device Status](#) dialog.

### Upper temp. limit [°C]

Specifies the upper temperature threshold in °C.

The “Installation” user manual contains detailed information about setting the temperature thresholds.

Possible values:

- ▶ `-99..99` (integer)  
If the temperature in the device exceeds this value, then the device generates an alarm.

### Lower temp. limit [°C]

Specifies the lower temperature threshold in °C.











The “Installation” user manual contains detailed information about setting the temperature thresholds.

Possible values:

- ▶ `-99..99` (integer)  
If the temperature in the device falls below this value, then the device generates an alarm.

## LED status







This frame displays the states of the device status LEDs at the time of the last update. The “Installation” user manual contains detailed information about the device status LEDs.

Parameters	Color	Meaning
<i>Status</i>		There is currently no device status alarm. The device status is OK.
		There is currently at least one device status alarm. Therefore, see the <a href="#">Device status</a> frame above.
<i>Power</i>		Device variant with 2 power supply units: Only one supply voltage is active.
		Device variant with 1 power supply unit: The supply voltage is active. Device variant with 2 power supply units: Both supply voltages are active.
<i>RM</i>		The device is neither operating as a <i>MRP</i> ring manager nor as a <i>DLR</i> supervisor.
		Loss of redundancy reserve. The device is operating as a <i>MRP</i> ring manager. or The device is operating as a <i>DLR</i> supervisor.
		Redundancy reserve is available. The device is operating as a <i>MRP</i> ring manager. or The device is operating as a <i>DLR</i> supervisor.
<i>ACA</i>		No external memory connected.
		The external memory is connected, but not ready for operation.
		The external memory is connected and ready for operation.

## Port status

This frame displays a simplified view of the ports of the device at the time of the last update.

The icons represent the status of the individual ports. In some situations, the following icons interfere with one another. When you position the mouse pointer over the appropriate port icon, a tooltip displays a detailed information about the port state.

Parameters	Status	Meaning
<Port number>		The port is inactive. The port does not send or receive any data.
		The port is inactive. The cable is connected. Active link.
		The port is active. No cable connected or no active link.
		The port is active. The cable is connected. Connection okay. Active link. Full-duplex mode
		The half-duplex mode is enabled. Verify the settings in the <a href="#">Basic Settings &gt; Ports</a> dialog, <a href="#">Configuration</a> tab.
		The port is in a blocking state due to a redundancy function.
		The port operates as a router interface.

## **Buttons**

You find the description of the standard buttons in section [“Buttons” on page 14](#).

## 1.2 Modules

[Basic Settings > Modules]



The device lets you install or remove the modules during operation (hot-plug).

As long as the *Ethernet module status* column displays the value *configurable* you can configure the module and save its preferences.

- ▶ When you replace the module with an identical module, the device applies the settings to the new module immediately.
- ▶ When you replace the module with a different type of module, the device applies the factory settings to the new module.
- ▶ When you plug a module in an empty slot, the device configures the module with its default settings. If the slot is inactive, then it remains inactive until you mark the checkbox in the *Active* column. With the port default settings loaded on the module, access to the network is possible.

### Install an Ethernet module

Perform the following steps:

- Plug the module in the slot.  
The device automatically configures the module with the default settings, and detects the module parameters.
- To update the Graphical User Interface, click the  button.  
The *Ethernet module status* column displays the value *physical* for the installed Ethernet module.
- To temporarily save the changes, click the  button.

### Activate/Deactivate a slot



On a deactivated slot, the device recognizes the installed module and port configuration is possible. The module establishes no network connections on a deactivated slot.

Perform the following steps:

- In the table highlight the module.
- To deactivate the slot and deny network access, unmark the *Active* checkbox.
- To activate the slot and allow network access, mark the *Active* checkbox.
- To temporarily save the changes, click the  button.

### Remove an Ethernet module

Perform the following steps:

- Remove the module from the slot.
- To update the Graphical User Interface, click the  button.  
The *Ethernet module status* column displays the value *configurable* for the removed module.
- In the table highlight the entry of the removed module.
- Click the  button and then the *Remove Ethernet module* item.  
The *Ethernet module status* column displays the value *remove* for the removed module.  
The *Type* column and some other columns display the value *n/a*.  
The marked *Active* checkbox indicates that the slot is still active.
- To temporarily save the changes, click the  button.



## Table

### Ethernet module

Displays the number of the slot to which the entry refers.

### Active

Activates/deactivates the slot.

Possible values:

- ▶ `marked` (default setting)  
The slot is active. The device recognizes a module installed in this slot.
- ▶ `unmarked`  
The slot is inactive.

### Type

Displays the type of the installed module.

A value of `n/a` indicates that the slot is empty.

### Description

Specifies a short description of the installed module.

### Version

Displays the version of the installed module.

### Ports

Displays how many ports are available on the installed module.

### Serial number

Displays the serial number of the installed module.

A value of `n/a` indicates that the slot is empty.

### Ethernet module status

Displays the status of the slot.

Possible values:

- ▶ `physical`  
A module is present in the slot.
- ▶ `configurable`  
The slot is empty and available for configuration.
- ▶ `remove`  
The slot is empty and deactivated.
- ▶ `fix`  
The module cannot be removed.

## Buttons

You find the description of the standard buttons in section [“Buttons” on page 14](#).

### Remove Ethernet module

Removes the selected Ethernet module from the table.

## 1.3 Network

[Basic Settings > Network]

The menu contains the following dialogs:

- ▶ [Global](#)
- ▶ [IPv4](#)

## 1.3.1 Global

[Basic Settings > Network > Global]

This dialog lets you specify the VLAN and HiDiscovery settings required for the access to the device management through the network.

### Management interface

This frame lets you specify the VLAN in which the device management can be accessed.

#### VLAN ID

Specifies the VLAN in which the device management is accessible through the network. The device management is accessible through ports that are members of this VLAN.

Possible values:

▶ 1..4042 (default setting: 1)

The prerequisite is that the VLAN is already configured. See the [Switching > VLAN > Configuration](#) dialog.

When you click the  button after changing the value, the *Information* window opens. Select the port, over which you connect to the device in the future. After clicking the *Ok* button, the new device management VLAN settings are assigned to the port.

- After that the port is a member of the VLAN and transmits the data packets without a VLAN tag (untagged). See the [Switching > VLAN > Configuration](#) dialog.
- The device assigns the port VLAN ID of the device management VLAN to the port. See the [Switching > VLAN > Port](#) dialog.

After a short time the device is reachable over the new port in the new device management VLAN.

#### MAC address

Displays the MAC address of the device. The device management is accessible via the network using the MAC address.

#### MAC Address Conflict Detection

Enables/disables the *MAC Address Conflict Detection* function.

Possible values:

▶ *marked*

The *MAC Address Conflict Detection* function is enabled.

The device verifies that its MAC address is unique in the network.

▶ *unmarked* (default setting)

The *MAC Address Conflict Detection* function is disabled.

## HiDiscovery protocol v1/v2

This frame lets you specify settings for the access to the device using the HiDiscovery protocol.

On a PC, the HiDiscovery software displays the Hirschmann devices that can be accessed in the network on which the HiDiscovery function is enabled. You can access these devices even if they have invalid or no IP parameters assigned. The HiDiscovery software lets you assign or change the IP parameters in the device.

**Note:** With the HiDiscovery software you access the device only through ports that are members of the same VLAN as the device management. You specify which VLAN a certain port is assigned to in the [Switching > VLAN > Configuration](#) dialog.

### Operation

Enables/disables the HiDiscovery function in the device.

Possible values:

- ▶ [On](#) (default setting)  
HiDiscovery is enabled.  
You can use the HiDiscovery software to access the device from your PC.
- ▶ [Off](#)  
HiDiscovery is disabled.

### Access

Enables/disables the write access to the device using HiDiscovery.

Possible values:

- ▶ [readWrite](#) (default setting)  
The HiDiscovery software is given write access to the device.  
With this setting you can change the IP parameters in the device.
- ▶ [readOnly](#)  
The HiDiscovery software is given read-only access to the device.  
With this setting you can view the IP parameters in the device.

Recommendation: Change the setting to the value [readOnly](#) only after putting the device into operation.

### Signal

Activates/deactivates the flashing of the port LEDs as does the function of the same name in the HiDiscovery software. The function lets you identify the device in the field.

Possible values:

- ▶ [marked](#)  
The flashing of the port LEDs is active.  
The port LEDs flash until you disable the function again.
- ▶ [unmarked](#) (default setting)  
The flashing of the port LEDs is inactive.

## **Buttons**

You find the description of the standard buttons in section [“Buttons” on page 14](#).

## 1.3.2 IPv4

[Basic Settings > Network > IPv4]

This dialog allows you to specify the IPv4 settings required for the access to the device management through the network.

### Management interface

#### IP address assignment

Specifies the source from which the device management receives its IP parameters.

Possible values:

- ▶ *Local*  
The device uses the IP parameters from the internal memory. You specify the settings for this in the *IP parameter* frame.
- ▶ *BOOTP*  
The device receives its IP parameters from a BOOTP or DHCP server.  
The server evaluates the MAC address of the device, then assigns the IP parameters.
- ▶ *DHCP* (default setting)  
The device receives its IP parameters from a DHCP server.  
The server evaluates the MAC address, the DHCP name, or other parameters of the device, then assigns the IP parameters.

**Note:** If there is no response from the BOOTP or DHCP server, then the device sets the IP address to *0.0.0.0* and makes another attempt to obtain a valid IP address.

### BOOTP/DHCP

#### Client ID

Displays the DHCP client ID that the device sends to the BOOTP or DHCP server. If the server is configured accordingly, then it reserves an IP address for this DHCP client ID. Therefore, the device receives the same IP from the server every time it requests it.

The DHCP client ID that the device sends is the device name specified in the *System name* field in the *Basic Settings > System* dialog.

#### DHCP Option 66/67/4/42

Enables/disables the *DHCP Option 66/67/4/42* function in the device.

Possible values:

- ▶ *On* (default setting)  
The *DHCP Option 66/67/4/42* function is enabled.  
The device loads the configuration profile and receives the time server information using the following DHCP options:

- Option 66: TFTP server name  
Option 67: Boot file name  
The device automatically loads the configuration profile from the DHCP server into the volatile memory (*RAM*) using the TFTP protocol. The device uses the settings of the imported configuration profile in the *running-config*.
- Option 4: Time Server  
Option 42: Network Time Protocol Servers  
The device receives the time server information from the DHCP server.
- ▶ *Off*  
The *DHCP Option 66/67/4/42* function is disabled.
  - The device does not load a configuration profile using DHCP Options 66/67.
  - The device does not receive time server information using DHCP Options 4/42.

### IP parameter

This frame lets you assign the IP parameters manually. If you have selected the *Local* radio button in the *Management interface* frame, *IP address assignment* option list, then these fields can be edited.

#### IP address

Specifies the IP address under which the device management can be accessed through the network.

Possible values:

- ▶ Valid IPv4 address

#### Netmask

Specifies the netmask.

Possible values:

- ▶ Valid IPv4 netmask

#### Gateway address

Specifies the IP address of a router through which the device accesses other devices outside its own network.

Possible values:

- ▶ Valid IPv4 address

### Buttons

You find the description of the standard buttons in section “Buttons” on page 14.

## 1.4 Software

[Basic Settings > Software]

This dialog lets you update the device software and display information about the device software.

You also have the option to restore a backup of the device software saved in the device.

**Note:** Before updating the device software, follow the version-specific notes in the [Readme](#) text file.

### Version

#### Stored version

Displays the version number and creation date of the device software stored in the flash memory. The device loads the device software during the next restart.

#### Running version

Displays the version number and creation date of the device software that the device loaded during the last restart and is currently running.

#### Backup version

Displays the version number and creation date of the device software saved as a backup in the flash memory. The device copied this device software into the backup memory during the last software update or after you clicked the [Restore](#) button.

#### Restore

Restores the device software saved as a backup. In the process, the device changes the [Stored version](#) and the [Backup version](#) of the device software.

Upon restart, the device loads the [Stored version](#).

#### Bootcode

Displays the version number and creation date of the boot code.

### Software update

Alternatively, when the image file is located in the external memory, the device lets you update the device software by right-clicking in the table.

#### URL

Specifies the path and the file name of the image file with which you update the device software.

The device gives you the following options for updating the device software:

► Software update from the PC

When the file is located on your PC or on a network drive, drag and drop the file in the  area. Alternatively click in the area to select the file.



- ▶ Software update from an FTP server  
When the file is located on an FTP server, specify the URL for the file in the following form:  
`ftp://<user>:<password>@<IP address>:<port>/<file name>`
- ▶ Software update from a TFTP server  
When the file is located on a TFTP server, specify the URL for the file in the following form:  
`tftp://<IP address>/<path>/<file name>`
- ▶ Software update from an SCP or SFTP server  
When the file is located on an SCP or SFTP server, specify the URL for the file in one of the following forms:
  - `scp://` or `sftp://<IP address>/<path>/<file name>`  
When you click the **Start** button, the device displays the **Credentials** window. There you enter **User name** and **Password**, to log in to the server.
  - `scp://` or `sftp://<user>:<password>@<IP address>/<path>/<file name>`

#### Start

Updates the device software.

The device installs the selected file in the flash memory, replacing the previously saved device software. Upon restart, the device loads the installed device software.

The device copies the existing software into the backup memory.

To remain logged in to the device during the software update, move the mouse pointer occasionally. Alternatively, specify a sufficiently high value in the **Device Security > Management Access > Web** dialog, field **Web interface session timeout [min]** before the software update.

#### Table

#### File location

Displays the storage location of the device software.

Possible values:

- ▶ *ram*  
Volatile memory of the device
- ▶ *flash*  
Non-volatile memory (NVM) of the device
- ▶ *sd-card*  
External SD memory (ACA31)
- ▶ *usb*  
External USB memory (ACA21/ACA22)

#### Index

Displays the index of the device software.

For the device software in the flash memory, the index has the following meaning:

- ▶ 1  
Upon restart, the device loads this device software.
- ▶ 2  
The device copied this device software into the backup area during the last software update.

File name

Displays the device-internal file name of the device software.

Firmware

Displays the version number and creation date of the device software.

**Buttons**

You find the description of the standard buttons in section [“Buttons” on page 14](#).

## 1.5 Load/Save

[Basic Settings > Load/Save]

This dialog lets you save the device settings permanently in a configuration profile.

The device can hold several configuration profiles. When you activate an alternative configuration profile, you change to other device settings. You have the option of exporting the configuration profiles to your PC or to a server. You also have the option of importing the configuration profiles from your PC or from a server to the device.

In the default setting, the device saves the configuration profiles unencrypted. If you enter a password in the [Configuration encryption](#) frame, then the device saves both the current and the future configuration profiles in an encrypted format.

Unintentional changes to the settings can terminate the connection between your PC and the device. To keep the device accessible, enable the [Undo configuration modifications](#) function before changing any settings. If the connection is lost, then the device loads the configuration profile saved in the non-volatile memory (*NVM*) after the specified time.

### External memory

Selected external memory

Specifies the external memory that the device uses for file operations. On this external memory, the device stores for example copies of the device configuration.

Possible values:

- ▶ [sd](#)  
External SD memory (ACA31)
- ▶ [usb](#)  
External USB memory (ACA21/ACA22)

Status

Displays the operating state of the selected external memory.

Possible values:

- ▶ [notPresent](#)  
No external memory connected.
- ▶ [removed](#)  
Someone has removed the external memory from the device during operation.
- ▶ [ok](#)  
The external memory is connected and ready for operation.
- ▶ [outOfMemory](#)  
The memory space is occupied in the external memory.
- ▶ [genericErr](#)  
The device has detected an error.

## Configuration encryption

### Active

Displays if the configuration encryption is active/inactive in the device.

Possible values:

▶ **marked**

The configuration encryption is active.

If the configuration profile is encrypted and the password matches the password stored in the device, then the device loads a configuration profile from the non-volatile memory (*NVM*).

▶ **unmarked**

The configuration encryption is inactive.

If the configuration profile is unencrypted, then the device loads a configuration profile from the non-volatile memory (*NVM*) only.

If in the *Basic Settings > External Memory* dialog, the *Config priority* column has the value *first* or *second* and the configuration profile is unencrypted, then the *Security status* frame in the *Basic Settings > System* dialog displays an alarm.

In the *Diagnostics > Status Configuration > Security Status* dialog, *Global* tab, *Monitor* column you specify if the device monitors the *Load unencrypted config from external memory* parameter.

### Set password

Opens the *Set password* window that helps you to enter the password needed for the configuration profile encryption. Encrypting the configuration profiles makes unauthorized access more difficult. To do this, perform the following steps:

- When you are changing an existing password, enter the existing password in the *Old password* field. To display the password in plain text instead of \*\*\*\*\* (asterisks), mark the *Display content* checkbox.
- In the *New password* field, enter the password. To display the password in plain text instead of \*\*\*\*\* (asterisks), mark the *Display content* checkbox.
- Mark the *Save configuration afterwards* checkbox to use encryption also for the Selected configuration profile in the non-volatile memory (*NVM*) and in the external memory.

**Note:** If a maximum of one configuration profile is stored in the non-volatile memory (*NVM*) of the device, then use this function only. Before creating additional configuration profiles, decide for or against permanently activated configuration encryption in the device. Save additional configuration profiles either unencrypted or encrypted with the same password.

If you are replacing a device with an encrypted configuration profile, for example due to a defect, then perform the following steps:

- Restart the new device and assign the IP parameters.
- Open the *Basic Settings > Load/Save* dialog on the new device.
- Encrypt the configuration profile in the new device. See above. Enter the same password you used in the defective device.
- Install the external memory from the defective device in the new device.
- Restart the new device.

When you restart the device, the device loads the configuration profile with the settings of the defective device from the external memory. The device copies the settings into the volatile memory (*RAM*) and into the non-volatile memory (*NVM*).

**Note:** The prerequisite for loading a configuration profile from the external memory is that in the [Basic Settings > External Memory](#) dialog the *Config priority* column displays the value `first` or `second`. This value is set as the default setting.

### Delete

Opens the [Delete](#) window which helps you to cancel the configuration encryption in the device. To cancel the configuration encryption, perform the following steps:

- In the [Old password](#) field, enter the existing password.  
To display the password in plain text instead of `*****` (asterisks), mark the [Display content](#) checkbox.
- Mark the [Save configuration afterwards](#) checkbox to remove the encryption also for the Selected configuration profile in the non-volatile memory ([NVM](#)) and in the external memory.

**Note:** If you keep additional encrypted configuration profiles in the memory, then the device helps prevent you from activating or designating these configuration profiles as "Selected".

### Information

#### NVM in sync with running config

Displays if the configuration profile in the volatile memory ([RAM](#)) and the "Selected" configuration profile in the non-volatile memory ([NVM](#)) are the same.

Possible values:

- ▶ `marked`  
The configuration profiles are the same.
- ▶ `unmarked`  
The configuration profiles differ.

#### External memory in sync with NVM

Displays if the "Selected" configuration profile in the external memory and the "Selected" configuration profile in the non-volatile memory ([NVM](#)) are the same.

Possible values:

- ▶ `marked`  
The configuration profiles are the same.
- ▶ `unmarked`  
The configuration profiles differ.

Possible causes:

- No external memory is connected to the device.
- In the [Basic Settings > External Memory](#) dialog, the [Backup config when saving](#) function is disabled.

## Backup config on a remote server when saving

### Operation

Enables/disables the *Backup config on a remote server when saving* function.

Possible values:

- ▶ *Enabled*  
The *Backup config on a remote server when saving* function is enabled.  
When you save the configuration profile in the non-volatile memory (*NVM*), the device automatically backs up the configuration profile on the remote server specified in the *URL* field.
- ▶ *Disabled* (default setting)  
The *Backup config on a remote server when saving* function is disabled.

### URL

Specifies path and file name of the backed up configuration profile on the remote server.

Possible values:

- ▶ Alphanumeric ASCII character string with 0..128 characters  
Example: `tftp://192.9.200.1/cfg/config.xml`  
The device supports the following wildcards:
  - `%d`  
System date in the format `YYYY-mm-dd`
  - `%t`  
System time in the format `HH_MM_SS`
  - `%i`  
IP address of the device
  - `%m`  
MAC address of the device in the format `AA-BB-CC-DD-EE-FF`
  - `%p`  
Product name of the device

### Set credentials

Opens the *Credentials* window which helps you to enter the login credentials needed to authenticate on the remote server. To do this, perform the following steps:

- In the *User name* field, enter the user name.  
To display the user name in plain text instead of \*\*\*\*\* (asterisks), mark the *Display content* checkbox.

Possible values:

- Alphanumeric ASCII character string with 1..32 characters

- In the *Password* field, enter the password.  
To display the password in plain text instead of \*\*\*\*\* (asterisks), mark the *Display content* checkbox.

Possible values:

- ▶ Alphanumeric ASCII character string with 6..64 characters

The following characters are allowed:

```
a..z
A..Z
0..9
!#$%&'()*+,-./:;<=>?@[\\]^_`{|}~
```

## Undo configuration modifications

### Operation

Enables/disables the *Undo configuration modifications* function. Using the function, the device continuously checks if it can still be reached from the IP address of your PC. If the connection is lost, after a specified time period the device loads the “Selected” configuration profile from the non-volatile memory (*NVM*). Afterwards, the device can be accessed again.

Possible values:

- ▶ *On*  
The function is enabled.
  - You specify the time period between the interruption of the connection and the loading of the configuration profile in the *Timeout [s] to recover after connection loss* field.
  - When the non-volatile memory (*NVM*) contains multiple configuration profiles, the device loads the configuration profile designated as “Selected”.
- ▶ *Off* (default setting)  
The function is disabled.  
Disable the function again before you close the Graphical User Interface. You thus help prevent the device from restoring the configuration profile designated as “Selected”.

**Note:** Before you enable the function, save the settings in the configuration profile. Current changes, that are saved temporarily, are therefore maintained in the device.

### Timeout [s] to recover after connection loss

Specifies the time in seconds after which the device loads the “Selected” configuration profile from the non-volatile memory (*NVM*) if the connection is lost.

Possible values:

- ▶ 30..600 (default setting: 600)

Specify a sufficiently large value. Take into account the time when you are viewing the dialogs of the Graphical User Interface without changing or updating them.

### Watchdog IP address

Displays the IP address of the PC on which you have enabled the function.

Possible values:

- ▶ IPv4 address (default setting: 0.0.0.0)

## Table

### Storage type

Displays the storage location of the configuration profile.

Possible values:

- ▶ *RAM* (volatile memory of the device)  
In the volatile memory, the device stores the settings for the current operation.

- ▶ *NVM* (non-volatile memory of the device)  
When applying the [Undo configuration modifications](#) function or during a restart, the device loads the “Selected” configuration profile from the non-volatile memory.  
The non-volatile memory provides space for multiple configuration profiles, depending on the number of settings saved in the configuration profile. The device manages a maximum of 20 configuration profiles in the non-volatile memory.  
You can load a configuration profile into the volatile memory (*RAM*). To do this, perform the following steps:
  - In the table highlight the configuration profile.
  - Click the  button and then the [Activate](#) item.
- ▶ *ENVM* (external memory)  
In the external memory, the device saves a backup copy of the “Selected” configuration profile. The prerequisite is that in the [Basic Settings > External Memory](#) dialog you mark the [Backup config when saving](#) checkbox.

#### Profile name

Displays the name of the configuration profile.

Possible values:

- ▶ `running-config`  
Name of the configuration profile in the volatile memory (*RAM*).
- ▶ `config`  
Name of the factory setting configuration profile in the non-volatile memory (*NVM*).
- ▶ User-defined name  
The device lets you save a configuration profile with a user-specified name by highlighting an existing configuration profile in the table, clicking the  button and then the [Save As..](#) item.

To export the configuration profile as an XML file on your PC, click the link. Then you select the storage location and specify the file name.

To save the file on a remote server, click the  button and then the [Export...](#) item.

#### Modification date (UTC)

Displays the time (UTC) at which a user last saved the configuration profile.

#### Selected

Displays if the configuration profile is designated as “Selected”.

Possible values:

- ▶ `marked`  
The configuration profile is designated as “Selected”.
  - When applying the [Undo configuration modifications](#) function or during a restart, the device loads the configuration profile into the volatile memory (*RAM*).
  - When you click the  button, the device saves the temporarily saved settings in this configuration profile.
- ▶ `unmarked`  
Another configuration profile is designated as “Selected”.

To designate another configuration profile as “Selected”, you highlight the desired configuration profile in the table, click the  button and then the [Activate](#) item.



### Encrypted

Displays if the configuration profile is encrypted.

Possible values:

- ▶ `marked`  
The configuration profile is encrypted.
- ▶ `unmarked`  
The configuration profile is unencrypted.

You activate/deactivate the encryption of the configuration profile in the [Configuration encryption](#) frame.

### Encryption verified

Displays if the password of the encrypted configuration profile matches the password stored in the device.

Possible values:

- ▶ `marked`  
The passwords match. The device is able to unencrypt the configuration profile.
- ▶ `unmarked`  
The passwords are different. The device is unable to unencrypt the configuration profile.

### Software version

Displays the version number of the device software that the device ran while saving the configuration profile.

### Fingerprint

Displays the checksum saved in the configuration profile.

When saving the settings, the device calculates the checksum and inserts it into the configuration profile.

### Fingerprint verified

Displays if the checksum saved in the configuration profile is valid.

The device calculates the checksum of the configuration profile marked as “Selected” and compares it with the checksum saved in this configuration profile.

Possible values:

- ▶ `marked`  
The calculated and the saved checksum match.  
The saved settings are consistent.
- ▶ `unmarked`  
For the configuration profile marked as “Selected” applies:  
The calculated and the saved checksum are different.  
The configuration profile contains modified settings.  
Possible causes:
  - The file is damaged.
  - The file system in the external memory is inconsistent.
  - A user has exported the configuration profile and changed the XML file outside the device.For the other configuration profiles the device has not calculated the checksum.

The device verifies the checksum correctly only if the configuration profile has been saved before as follows:

- on an identical device
- with the same software version, which the device is running
- with a lower or the same level of the device software such as HiOS-2A or HiOS-3S on a device which runs HiOS-3S

**Note:** This function identifies changes to the settings in the configuration profile. The function does not provide protection against operating the device with modified settings.

## Buttons

You find the description of the standard buttons in section “Buttons” on page 14.



Removes the configuration profile highlighted in the table from the non-volatile memory (*NVM*) or from the external memory.

If the configuration profile is designated as "Selected", then the device helps prevent you from removing the configuration profile.

### Save As..

Copies the configuration profile highlighted in the table and saves it with a user-specified name in the non-volatile memory (*NVM*). The device designates the new configuration profile as “Selected”.

**Note:** Before creating additional configuration profiles, decide for or against permanently activated configuration encryption in the device. Save additional configuration profiles either unencrypted or encrypted with the same password.

If in the *Basic Settings > External Memory* dialog the checkbox in the *Backup config when saving* column is marked, then the device designates the configuration profile of the same name in the external memory as “Selected”.

### Activate

Loads the settings of the configuration profile highlighted in the table to the volatile memory (*RAM*).

- ▶ The device terminates the connection to the Graphical User Interface. To access the device management again, perform the following steps:
  - Reload the Graphical User Interface.
  - Log in again.
- ▶ The device immediately uses the settings of the configuration profile on the fly.

Enable the *Undo configuration modifications* function before you activate another configuration profile. If the connection is lost afterwards, then the device loads the last configuration profile designated as “Selected” from the non-volatile memory (*NVM*). The device can then be accessed again.

If the configuration encryption is inactive, then the device loads an unencrypted configuration profile. If the configuration encryption is active and the password matches the password stored in the device, then the device loads an encrypted configuration profile.

When you activate an older configuration profile, the device takes over the settings of the functions contained in this software version. The device sets the values of new functions to their default value.

#### Select

Designates the configuration profile highlighted in the table as “Selected”. In the *Selected* column, the checkbox is then *marked*.

When applying the *Undo configuration modifications* function or during a restart, the device loads the settings of this configuration profile to the volatile memory (*RAM*).

- ▶ If the configuration encryption in the device is disabled, then designate an unencrypted configuration profile only as “Selected”.
- ▶ If the configuration encryption in the device is enabled and the password of the configuration profile matches the password saved in the device, then designate an encrypted configuration profile only as “Selected”.

Otherwise, the device is unable to load and encrypt the settings in the configuration profile the next time it restarts. For this case you specify in the *Diagnostics > System > Selftest* dialog if the device starts with the default settings or terminates the restart and stops.

**Note:** You only mark the configuration profiles saved in the non-volatile memory (*NVM*).

If in the *Basic Settings > External Memory* dialog the checkbox in the *Backup config when saving* column is marked, then the device designates the configuration profile of the same name in the external memory as “Selected”.

#### Import...

Opens the *Import...* window to import a configuration profile.

The prerequisite is that you have exported the configuration profile using the *Export...* button or using the link in the *Profile name* column.

- In the *Select source* drop-down list, select from where the device imports the configuration profile.
  - ▶ *PC/URL*  
The device imports the configuration profile from the local PC or from a remote server.
  - ▶ *External memory*  
The device imports the configuration profile from the selected external memory. See the *External memory* frame.
- When *PC/URL* is selected above, in the *Import profile from PC/URL* frame you specify the configuration profile file to be imported.
  - Import from the PC  
When the file is located on your PC or on a network drive, drag and drop the file in the  area. Alternatively click in the area to select the file.
  - Import from an FTP server  
When the file is located on an FTP server, specify the URL for the file in the following form:  
`ftp://<user>:<password>@<IP address>:<port>/<file name>`

- Import from a TFTP server  
When the file is located on a TFTP server, specify the URL for the file in the following form:  
`tftp://<IP address>/<path>/<file name>`
- Import from an SCP or SFTP server  
When the file is located on an SCP or SFTP server, specify the URL for the file in one of the following forms:  
`scp://` or `sftp://<IP address>/<path>/<file name>`  
When you click the **Start** button, the device displays the **Credentials** window. There you enter **User name** and **Password**, to log in to the server.  
`scp://` or `sftp://<user>:<password>@<IP address>/<path>/<file name>`
- When **External memory** is selected above, in the **Import profile from external memory** frame you specify the configuration profile file to be imported.  
In the **Profile name** drop-down list, select the name of the configuration profile to be imported.
- In the **Destination** frame you specify where the device saves the imported configuration profile.  
In the **Profile name** field you specify the name under which the device saves the configuration profile.  
In the **Storage type** field you specify the storage location for the configuration profile. The prerequisite is that in the **Select source** drop-down list you select the **PC/URL** item.
  - ▶ **RAM**  
The device saves the configuration profile in the volatile memory (**RAM**) of the device. This replaces the **running-config**, the device uses the settings of the imported configuration profile immediately. The device terminates the connection to the Graphical User Interface. Reload the Graphical User Interface. Log in again.
  - ▶ **NVM**  
The device saves the configuration profile in the non-volatile memory (**NVM**) of the device.

When you import a configuration profile, the device takes over the settings as follows:

- If the configuration profile was exported on the same device or on an identically equipped device of the same type, then:  
The device takes over the settings completely.  
If the device uses modules, then also read the help text of the **Basic Settings > Modules** dialog.
- If the configuration profile was exported on an other device, then:  
The device takes over the settings which it can interpret based on its hardware equipment and software level.  
The remaining settings the device takes over from its **running-config** configuration profile.

Regarding configuration profile encryption, also read the help text of the **Configuration encryption** frame. The device imports a configuration profile under the following conditions:

- The configuration encryption of the device is inactive. The configuration profile is unencrypted.
- The configuration encryption of the device is active. The configuration profile is encrypted with the same password that the device currently uses.

## Export...

Exports the configuration profile highlighted in the table and saves it as an XML file on a remote server.

To save the file on your PC, click the link in the **Profile name** column to select the storage location and specify the file name.

The device gives you the following options for exporting a configuration profile:

- ▶ **Export to an FTP server**  
To save the file on an FTP server, specify the URL for the file in the following form:  
`ftp://<user>:<password>@<IP address>:<port>/<file name>`

- ▶ Export to a TFTP server  
To save the file on a TFTP server, specify the URL for the file in the following form:  
`tftp://<IP address>/<path>/<file name>`
- ▶ Export to an SCP or SFTP server  
To save the file on an SCP or SFTP server, specify the URL for the file in one of the following forms:
  - `scp:// or sftp://<IP address>/<path>/<file name>`  
When you click the **Ok** button, the device displays the **Credentials** window. There you enter **User name** and **Password**, to log in to the server.
  - `scp:// or sftp://<user>:<password>@<IP address>/<path>/<file name>`

### Load running-config as script

Imports a script file which modifies the current **running config** configuration profile.

The device gives you the following options to import a script file:

- ▶ Import from the PC  
When the file is located on your PC or on a network drive, drag and drop the file in the  area. Alternatively click in the area to select the file.
- ▶ Import from an FTP server  
When the file is located on an FTP server, specify the URL for the file in the following form:  
`ftp://<user>:<password>@<IP address>:<port>/<file name>`
- ▶ Import from a TFTP server  
When the file is located on a TFTP server, specify the URL for the file in the following form:  
`tftp://<IP address>/<path>/<file name>`
- ▶ Import from an SCP or SFTP server  
When the file is located on an SCP or SFTP server, specify the URL for the file in one of the following forms:  
`scp:// or sftp://<IP address>/<path>/<file name>`

### Save running-config as script

Saves the **running config** configuration profile as a script file on the local PC. This lets you backup your current device settings or to use them on various devices.

### Back to factory...

Resets the settings in the device to the default values.

- ▶ The device deletes the saved configuration profiles from the volatile memory (**RAM**) and from the non-volatile memory (**NVM**).
- ▶ The device deletes the HTTPS certificate used by the web server in the device.
- ▶ The device deletes the RSA key (Host Key) used by the SSH server in the device.
- ▶ When an external memory is connected, the device deletes the configuration profiles saved in the external memory.
- ▶ After a brief period, the device reboots and loads the default values.

### Back to default

Deletes the current operating (**running config**) settings from the volatile memory (**RAM**).

## 1.6 External Memory

[Basic Settings > External Memory]

This dialog lets you activate functions that the device automatically executes in combination with the external memory. The dialog also displays the operating state and identifying characteristics of the external memory.

### Configuration

#### USB mode

Specifies the mode of communication between the device and the external memory. To activate the changes to this field, save the settings permanently and restart the device.

Possible values:

- ▶ *normal* (USB 2.0 mode)  
Device and external memory communicate in the high-speed mode (480 Mbit/s).
- ▶ *compatibility* (USB 1.1 compatibility mode)  
Device and external memory communicate in the full-speed mode (12 Mbit/s).

**Note:** The external memory ACA21 operates only in the USB 1.1 compatibility mode. If you use this external memory, then specify the value *compatibility*.

### Information

#### Current USB mode

Displays the mode the device currently uses for the communication with the external memory.

Possible values:

- ▶ *normal* (USB 2.0 mode)  
Device and external memory communicate in the high-speed mode (480 Mbit/s).
- ▶ *compatibility* (USB 1.1 compatibility mode)  
Device and external memory communicate in the full-speed mode (12 Mbit/s).

### Table

#### Type

Displays the type of the external memory.

Possible values:

- ▶ *sd*  
External SD memory (ACA31)
- ▶ *usb*  
External USB memory (ACA21/ACA22)

### Status

Displays the operating state of the external memory.

Possible values:

- ▶ `notPresent`  
No external memory connected.
- ▶ `removed`  
Someone has removed the external memory from the device during operation.
- ▶ `ok`  
The external memory is connected and ready for operation.
- ▶ `outOfMemory`  
The memory space is occupied in the external memory.
- ▶ `genericErr`  
The device has detected an error.

### Writable

Displays if the device has write access to the external memory.

Possible values:

- ▶ `marked`  
The device has write access to the external memory.
- ▶ `unmarked`  
The device has read-only access to the external memory. Possibly the write protection is activated in the external memory.

### Software auto update

Activates/deactivates the automatic device software update during the restart.

Possible values:

- ▶ `marked` (default setting)  
The automatic device software update during the restart is activated. The device updates the device software when the following files are located in the external memory:
  - the image file of the device software
  - a text file `startup.txt` with the content `autoUpdate=<image_file_name>.bin`
- ▶ `unmarked`  
The automatic device software update during the restart is deactivated.

### SSH key auto upload

Activates/deactivates the loading of the RSA key from an external memory upon restart.

Possible values:

- ▶ `marked` (default setting)  
The loading of the RSA key is activated.  
During a restart, the device loads the RSA key from the external memory when the following files are located in the external memory:
  - SSH RSA key file
  - a text file `startup.txt` with the content `autoUpdateRSA=<filename_of_the_SSH_RSA_key>`The device displays messages on the system console of the serial interface.
- ▶ `unmarked`  
The loading of the RSA key is deactivated.

**Note:** When loading the RSA key from the external memory (*ENVM*), the device overwrites the existing keys in the non-volatile memory (*NVM*).

#### Config priority

Specifies the memory from which the device loads the configuration profile upon reboot.

Possible values:

- ▶ *disable*  
The device loads the configuration profile from the non-volatile memory (*NVM*).
- ▶ *first, second*  
The device loads the configuration profile from the external memory designated as *first*. When the device does not find a configuration profile there, it loads the configuration profile from the external memory designated as *second*, and so on.  
When the device does not find a configuration profile in the external memory, it loads the configuration profile from the non-volatile memory (*NVM*).

**Note:** When loading the configuration profile from the external memory (*ENVM*), the device overwrites the settings of the Selected configuration profile in the non-volatile memory (*NVM*).

If the *Config priority* column has the value *first* or *second* and the configuration profile is unencrypted, then the *Security status* frame in the *Basic Settings > System* dialog displays an alarm.

In the *Diagnostics > Status Configuration > Security Status* dialog, *Global* tab, *Monitor* column you specify if the device monitors the *Load unencrypted config from external memory* parameter.

#### Backup config when saving

Activates/deactivates creating a copy of the configuration profile in the external memory.

Possible values:

- ▶ *marked* (default setting)  
Creating a copy is activated. When you click in the *Basic Settings > Load/Save* dialog the *Save* button, the device generates a copy of the configuration profile on the active external memory.
- ▶ *unmarked*  
Creating a copy is deactivated. The device does not generate a copy of the configuration profile.

#### Manufacturer ID

Displays the name of the memory manufacturer.

#### Revision

Displays the revision number specified by the memory manufacturer.

#### Version

Displays the version number specified by the memory manufacturer.

#### Name

Displays the product name specified by the memory manufacturer.



### Serial number

Displays the serial number specified by the memory manufacturer.

### **Buttons**

You find the description of the standard buttons in section [“Buttons” on page 14](#).

## 1.7 Port

[Basic Settings > Port]

This dialog lets you specify settings for the individual ports. The dialog also displays the operating mode, connection status, bit rate and duplex mode for every port.

The dialog contains the following tabs:

- ▶ [Configuration]
- ▶ [Statistics]
- ▶ [Utilization]

### [Configuration]

#### Table

Port

Displays the port number.

Name

Name of the port.

Possible values:

- ▶ Alphanumeric ASCII character string with 0..64 characters  
The following characters are allowed:
  - <space>
  - 0..9
  - a..z
  - A..Z
  - !#\$%&'()\*+,-./:;<=>?@[\\]^\_`{|}~

Port on

Activates/deactivates the port.

Possible values:

- ▶ `marked` (default setting)  
The port is active.
- ▶ `unmarked`  
The port is inactive. The port does not send or receive any data.

#### State

Displays if the port is currently physically enabled or disabled.

Possible values:

- ▶ `marked`  
The port is physically enabled.
- ▶ `unmarked`  
The port is physically disabled.  
When the [Port on](#) function is active, the [Auto-Disable](#) function has disabled the port.  
You specify the settings of the [Auto-Disable](#) function in the [Diagnostics > Ports > Auto-Disable](#) dialog.

#### Power state (port off)

Specifies if the port is physically switched on or off when you deactivate the port with the [Port on](#) function.

Possible values:

- ▶ `marked`  
The port remains physically enabled. A connected device receives an active link.
- ▶ `unmarked` (default setting)  
The port is physically disabled.

#### Auto power down

Specifies how the port behaves when no cable is connected.

Possible values:

- ▶ `no-power-save` (default setting)  
The port remains activated.
- ▶ `auto-power-down`  
The port changes to the energy-saving mode.
- ▶ `unsupported`  
The port does not support this function and remains activated.

#### Automatic configuration

Activates/deactivates the automatic selection of the operating mode for the port.

Possible values:

- ▶ `marked` (default setting)  
The automatic selection of the operating mode is active.  
The port negotiates the operating mode independently using autonegotiation and detects the devices connected to the TP port automatically (Auto Cable Crossing). This setting has priority over the manual setting of the port.  
Elapse several seconds until the port has set the operating mode.
- ▶ `unmarked`  
The automatic selection of the operating mode is inactive.  
The port operates with the values you specify in the [Manual configuration](#) column and in the [Manual cable crossing \(Auto. conf. off\)](#) column.
- ▶ Grayed-out display  
No automatic selection of the operating mode.

#### Manual configuration

Specifies the operating mode of the ports when the *Automatic configuration* function is disabled.

Possible values:

- ▶ 10 Mbit/s HDX  
Half duplex connection
- ▶ 10 Mbit/s FDX  
Full duplex connection
- ▶ 100 Mbit/s HDX  
Half duplex connection
- ▶ 100 Mbit/s FDX  
Full duplex connection
- ▶ 1000 Mbit/s FDX  
Full duplex connection

**Note:** The operating modes of the port actually available depend on the device configuration and the media module used.

#### Link/Current settings

Displays the operating mode which the port currently uses.

Possible values:

- ▶ -  
No cable connected, no link.
- ▶ 10 Mbit/s HDX  
Half duplex connection
- ▶ 10 Mbit/s FDX  
Full duplex connection
- ▶ 100 Mbit/s HDX  
Half duplex connection
- ▶ 100 Mbit/s FDX  
Full duplex connection
- ▶ 1000 Mbit/s FDX  
Full duplex connection

**Note:** The operating modes of the port actually available depend on the device configuration and the media module used.

#### Manual cable crossing (Auto. conf. off)

Specifies the devices connected to a TP port.

The prerequisite is that the *Automatic configuration* function is disabled.

Possible values:

- ▶ *mdi*  
The device interchanges the send- and receive-line pairs on the port.
- ▶ *mdix* (default setting on TP ports)  
The device helps prevent the interchange of the send- and receive-line pairs on the port.

- ▶ [auto-mdix](#)  
The device detects the send and receive line pairs of the connected device and automatically adapts to them.  
Example: When you connect an end device with a crossed cable, the device automatically resets the port from [mdix](#) to [mdi](#).
- ▶ [unsupported](#) (default setting on optical ports or TP-SFP ports)  
The port does not support this function.

### Flow control

Activates/deactivates the flow control on the port.

Possible values:

- ▶ [marked](#) (default setting)  
The Flow control on the port is active.  
The sending and evaluating of pause packets (full-duplex operation) or collisions (half-duplex operation) is activated on the port.
  - To enable the flow control in the device, also activate the [Flow control](#) function in the [Switching > Global](#) dialog.
  - Activate the flow control also on the port of the device that is connected to this port.  
On an uplink port, activating the flow control can possibly cause undesired sending breaks in the higher-level network segment (“wandering backpressure”).
- ▶ [unmarked](#)  
The Flow control on the port is inactive.

If you are using a redundancy function, then you deactivate the flow control on the participating ports. If the flow control and the redundancy function are active at the same time, it is possible that the redundancy function operates differently than intended.

### Send trap (Link up/down)

Activates/deactivates the sending of SNMP traps when the device detects changes in the link up/down status for this port.

Possible values:

- ▶ [marked](#) (default setting)  
The sending of SNMP traps is active.  
When the device detects a link up/down status change, the device sends an SNMP trap.
- ▶ [unmarked](#)  
The sending of SNMP traps is inactive.

The prerequisite for sending SNMP traps is that you enable the function in the [Diagnostics > Status Configuration > Alarms \(Traps\)](#) dialog and specify at least one trap destination.

### MTU

Specifies the maximum allowed size of Ethernet packets on the port in bytes.

When the [TSN](#) function is enabled, on a TSN-capable port the device uses the [Max. SDU](#) value instead of this value. See the [Switching > TSN > SDU](#) dialog.

Possible values:

- ▶ [1518..12288](#) (default setting: [1518](#))  
With the setting [1518](#), the port transmits the Ethernet packets up to the following size:

- 1518 bytes without VLAN tag  
(1514 bytes + 4 bytes CRC)
- 1522 bytes with VLAN tag  
(1518 bytes + 4 bytes CRC)

This setting lets you increase the max. allowed size of Ethernet packets that this port can receive or transmit.

The following list contains possible applications:

- ▶ When you use the PRP redundancy protocol, it is possible that you require an *MTU* that is larger by 6 bytes. (depends on hardware)
- ▶ When you use the device in the transfer network with double VLAN tagging, it is possible that you require an *MTU* that is larger by 4 bytes.

On other interfaces, you specify the maximum permissible size of the Ethernet packets as follows:

- *HSR* interfaces (depends on hardware)  
[Switching > L2-Redundancy > HSR > Configuration](#) dialog, [Configuration](#) frame, *MTU* field
- *PRP* interfaces (depends on hardware)  
[Switching > L2-Redundancy > PRP > Configuration](#) dialog, [Configuration](#) frame, *MTU* field
- *Link Aggregation* interfaces  
[Switching > L2-Redundancy > Link Aggregation](#) dialog, *MTU* column

## Signal

Activates/deactivates the port LED flashing. This function lets you identify the port in the field.

Possible values:

- ▶ *marked*  
The flashing of the port LED is active.  
The port LED flashes until you disable the function again.
- ▶ *unmarked* (default setting)  
The flashing of the port LED is inactive.

## Buttons

You find the description of the standard buttons in section “Buttons” on page 14.

## Clear port statistics

Resets the counter for the port statistics to 0.

## [Statistics]

This tab displays the following overview per port:

- ▶ Number of data packets/bytes received in the device
  - [Received packets](#)
  - [Received octets](#)
  - [Received unicast packets](#)
  - [Received multicast packets](#)
  - [Received broadcast packets](#)

- ▶ Number of data packets/bytes sent from the device
  - *Transmitted packets*
  - *Transmitted octets*
  - *Transmitted unicast packets*
  - *Transmitted multicast packets*
  - *Transmitted broadcast packets*
- ▶ Number of errors detected by the device
  - *Received fragments*
  - *Detected CRC errors*
  - *Detected collisions*
- ▶ Number of data packets per size category received in the device
  - *Packets 64 bytes*
  - *Packets 65 to 127 bytes*
  - *Packets 128 to 255 bytes*
  - *Packets 256 to 511 bytes*
  - *Packets 512 to 1023 bytes*
  - *Packets 1024 to 1518 bytes*
- ▶ Number of data packets discarded by the device
  - *Received discards*
  - *Transmitted discards*

To sort the table by a specific criterion click the header of the corresponding row.

For example, to sort the table based on the number of received bytes in ascending order, click the header of the *Received octets* column once. To sort in descending order, click the header again.

To reset the counter for the port statistics in the table to 0, perform the following steps:

- ▶ In the *Basic Settings > Port* dialog, click the  button and then the *Clear port statistics* item.  
or
- ▶ In the *Basic Settings > Restart* dialog, click the *Clear port statistics* button.

### Buttons

You find the description of the standard buttons in section “Buttons” on page 14.

#### Clear port statistics

Resets the counter for the port statistics to 0.

### [Utilization]

This tab displays the utilization (network load) for the individual ports.

### Table

#### Port

Displays the port number.

#### Utilization [%]

Displays the current utilization in percent in relation to the time interval specified in the [Control interval \[s\]](#) column.

The utilization is the relationship of the received data quantity to the maximum possible data quantity at the currently configured data rate.

#### Lower threshold [%]

Specifies a lower threshold for the utilization. If the utilization of the port falls below this value, then the [Alarm](#) column displays an alarm.

Possible values:

▶ 0.00..100.00 (default setting: 0.00)

The value 0 deactivates the lower threshold.

#### Upper threshold [%]

Specifies an upper threshold for the utilization. If the utilization of the port exceeds this value, then the [Alarm](#) column displays an alarm.

Possible values:

▶ 0.00..100.00 (default setting: 0.00)

The value 0 deactivates the upper threshold.

#### Control interval [s]

Specifies the interval in seconds.

Possible values:

▶ 1..3600 (default setting: 30)

#### Alarm

Displays the utilization alarm status.

Possible values:

▶ [marked](#)

The utilization of the port is below the value specified in the [Lower threshold \[%\]](#) column or above the value specified in the [Upper threshold \[%\]](#) column. The device sends an SNMP trap.

▶ [unmarked](#)

The utilization of the port is above the value specified in the [Lower threshold \[%\]](#) column and below the value specified in the [Upper threshold \[%\]](#) column.

The prerequisite for sending SNMP traps is that you enable the function in the [Diagnostics > Status Configuration > Alarms \(Traps\)](#) dialog and specify at least one trap destination.



## Buttons

You find the description of the standard buttons in section “Buttons” on page 14.

### Clear port statistics

Resets the counter for the port statistics to 0.

## 1.8 Power over Ethernet

[Basic Settings > Power over Ethernet]

In Power over Ethernet (PoE), the Power Source Equipment (PSE) supplies current to powered devices (PD) such as IP phones through the twisted pair cable.

The product code and the PoE-specific labeling on the PSE device housing indicates if your device supports *Power over Ethernet*. The PoE ports of the device support Power over Ethernet according to IEEE 802.3at.

The system provides an internal maximum power budget for the ports. The ports reserve power according to the detected class of a connected powered device. The real delivered power is equal to or less than the reserved power.

You manage the power output with the *Priority* parameter. When the sum of the power required by the connected devices exceeds the power available, the device turns off power supplied to the ports according to configured priority. The device turns off power supplied to the ports starting with ports configured as a low priority first. When several ports have a low priority, the device turns off power starting with the higher numbered ports.

The menu contains the following dialogs:

- ▶ PoE Global
- ▶ PoE Port

## 1.8.1 PoE Global

[Basic Settings > Power over Ethernet > Global]

Based on the settings specified in this dialog, the device provides power to the end-user devices. If the power consumption reaches the user-specified threshold, then the device sends an SNMP trap.

### Operation

Operation

Enables/disables the *Power over Ethernet* function.

Possible values:

- ▶ *On* (default setting)  
The *Power over Ethernet* function is enabled.
- ▶ *Off*  
The *Power over Ethernet* function is disabled.

### Configuration

Send trap

Activates/deactivates the sending of SNMP traps.

If the power consumption exceeds the user-specified threshold, then the device sends an SNMP trap.

Possible values:

- ▶ *marked* (default setting)  
The device sends SNMP traps.
- ▶ *unmarked*  
The device does not send any SNMP traps.

The prerequisite for sending SNMP traps is that you enable the function in the *Diagnostics > Status Configuration > Alarms (Traps)* dialog and specify at least one trap destination.

Threshold [%]

Specifies the threshold value for the power consumption in percent.

If the power output exceeds this threshold, then the device measures the total output power and sends an SNMP trap.

Possible values:

▶ 0..99 (default setting: 90)

### System power

Budget [W]

Displays the sum of the power available for the global budget.

Reserved [W]

Displays the global reserved power. The device reserves power according to the detected classes of connected powered devices. Reserved power is equal to or less than the actual delivered power.

Delivered [W]

Displays the actual power delivered to the modules in watts.

Delivered [mA]

Displays the actual current delivered to the modules in milliamperes.

### Table

Module

Device module to which the table entries relate.

Configured power budget [W]

Specifies the power of the modules for the distribution at the ports.

Possible values:

▶ 0..n (default setting: n)

Here, n corresponds to the value in the *Max. power budget [W]* column.

Max. power budget [W]

Displays the maximum power available for this module.

Reserved power [W]

Displays the power reserved for the module according to the detected classes of the connected powered devices.

Delivered power [W]

Displays the actual power in watts delivered to powered devices connected to this port.

#### Delivered current [mA]

Displays the actual current in milliamperes delivered to powered devices connected to this port.

#### Power source

Displays the power sourcing equipment for the device.

Possible values:

- ▶ *internal*  
Internal power source
- ▶ *external*  
External power source

#### Threshold [%]

Specifies the threshold value for the power consumption of the module in percent. If the power output exceeds this threshold, then the device measures the total output power and sends an SNMP trap.

Possible values:

- ▶ *0..99* (default setting: 90)

#### Send trap

Activates/deactivates the sending of SNMP traps if the device detects that the threshold value for the power consumption exceeds.

Possible values:

- ▶ *marked*  
The sending of SNMP traps is active.  
If the power consumption of the module exceeds the user-defined threshold, then the device sends an SNMP trap.
- ▶ *unmarked* (default setting)  
The sending of SNMP traps is inactive.

The prerequisite for sending SNMP traps is that you enable the function in the [Diagnostics > Status Configuration > Alarms \(Traps\)](#) dialog and specify at least one trap destination.

### Buttons

You find the description of the standard buttons in section [“Buttons” on page 14](#).

## 1.8.2 PoE Port

[Basic Settings > Power over Ethernet > Port]

When power consumption is higher than deliverable power, the device turns off power to the powered devices (PD) according to the priority levels and port numbers. When the PDs connected require more power than the device provides, the device deactivates the *Power over Ethernet* function on the ports. The device disables the *Power over Ethernet* function on the ports with the lowest priority first. When multiple ports have the same priority, the device first disables the *Power over Ethernet* function on the ports with the higher port number. The device also turns off power to powered devices (PD) for a specified time period.

### Table

Port

Displays the port number.

PoE enable

Activates/deactivates the PoE power provided to the port.

When the function is activated or deactivated, the device logs an event in the log file (System Log).

Possible values:

- ▶ `marked` (default setting)  
Providing PoE power to the port is active.
- ▶ `unmarked`  
Providing PoE power to the port is inactive.

Fast startup

Activates/deactivates the Power over Ethernet Fast Startup function on the port.

The prerequisite is that the checkbox in the *PoE enable* column is marked.

Possible values:

- ▶ `marked`  
The fast start up function is active. The device sends power to the powered devices (PD) immediately after turning the power to the device on.
- ▶ `unmarked` (default setting)  
The fast start up function is inactive. The device sends power to the powered devices (PD) after loading its own configuration.

Priority

Specifies the port priority.

To help prevent current overloads, the device disables ports with low priority first. To help prevent that the device disables the ports supplying necessary devices, specify a high priority for these ports.

Possible values:

- ▶ *critical*
- ▶ *high*
- ▶ *low* (default setting)

#### Status

Displays the status of the port Powered Device (PD) detection.

Possible values:

- ▶ *disabled*  
The device is in the DISABLED state and is not delivering power to the powered devices.
- ▶ *deliveringPower*  
The device identified the class of the connected PD and is in the POWER ON state.
- ▶ *fault*  
The device is in the TEST ERROR state.
- ▶ *otherFault*  
The device is in the IDLE state.
- ▶ *searching*  
The device is in a state other than the listed states.
- ▶ *test*  
The device is in the TEST MODE.

#### Detected class

Displays the power class of the powered device connected to the port.

Possible values:

- ▶ *Class 0*
- ▶ *Class 1*
- ▶ *Class 2*
- ▶ *Class 3*
- ▶ *Class 4*

Class 0  
Class 1  
Class 2  
Class 3  
Class 4

Activates/deactivates the current of the classes 0 to 4 on the port.

Possible values:

- ▶ *marked* (default setting)
- ▶ *unmarked*

## Basic Settings

[Basic Settings > Power over Ethernet > Port]

---

### Consumption [W]

Displays the current power consumption of the port in watts.

Possible values:

▶ 0, 0..30, 0

### Consumption [mA]

Displays the current delivered to the port in milliamperes.

Possible values:

▶ 0..600

### Power limit [W]

Specifies the maximum power in watts that the port outputs.

This function lets you distribute the power budget available among the PoE ports as required.

For example, for a connected device not providing a “Power Class”, the port reserves a fixed amount of 15.4 W (class 0) even if the device requires less power. The surplus power is not available to any other port.

By specifying the power limit, you reduce the reserved power to the actual requirement of the connected device. The unused power is available to other ports.

If the exact power consumption of the connected powered device is unknown, then the device displays the value in the *Max. consumption [W]* column. Verify that the power limit is greater than the value in the *Max. consumption [W]* column.

If the maximum observed power is greater than the set power limit, then the device sees the power limit as invalid. In this case, the device uses the PoE class for the calculation.

Possible values:

▶ 0, 0..30, 0 (default setting: 0)

### Max. consumption [W]

Displays the maximum power in watts that the device has consumed so far.

You reset the value when you disable PoE on the port or terminate the connection to the connected device.

### Name

Specifies the name of the port.

Specify the name of your choice.

Possible values:

- ▶ Alphanumeric ASCII character string with 0..32 characters

Auto-shutdown power

Activates/deactivates the *Auto-shutdown power* function according to the settings.

Possible values:

- ▶ `marked`
- ▶ `unmarked` (default setting)

Disable power at [hh:mm]

Specifies the time at which the device disables the power for the port upon activation of the *Auto-shutdown power* function.

Possible values:

- ▶ `00:00..23:59` (default setting: `00:00`)

Re-enable power at [hh:mm]

Specifies the time at which the device enables the power for the port upon activation of the *Auto-shutdown power* function.

Possible values:

- ▶ `00:00..23:59` (default setting: `00:00`)

## Buttons

You find the description of the standard buttons in section “Buttons” on page 14.

## 1.9 Restart

[Basic Settings > Restart]

This dialog lets you restart the device, reset port counters and address tables, and delete log files.

### Restart

Restart in

Displays the remaining time until the device restarts.

To update the display of the remaining time, click the  button.



#### Cancel

Aborts a delayed restart.

#### Cold start...

Opens the [Restart](#) dialog to initiate an immediate or delayed restart of the device.

If the configuration profile in the volatile memory (*RAM*) and the "Selected" configuration profile in the non-volatile memory (*NVM*) differ, then the device displays the [Warning](#) dialog.

- To permanently save the changes, click the [Yes](#) button in the [Warning](#) dialog.
- To discard the changes, click the [No](#) button in the [Warning](#) dialog.
- In the [Restart in](#) field you specify the delay time for the delayed restart.

Possible values:

- 00:00:00..596:31:23 (default setting: 00:00:00)

When the delay time elapsed, the device restarts and goes through the following phases:

- ▶ If you activate the function in the [Diagnostics > System > Selftest](#) dialog, then the device performs a RAM test.
- ▶ The device starts the device software that the [Stored version](#) field displays in the [Basic Settings > Software](#) dialog.
- ▶ The device loads the settings from the "Selected" configuration profile. See the [Basic Settings > Load/Save](#) dialog.

**Note:** During the restart, the device does not transfer any data. During this time, the device cannot be accessed by the Graphical User Interface or other management systems.

## Buttons

You find the description of the standard buttons in section “Buttons” on page 14.

#### Reset MAC address table

Removes the MAC addresses from the forwarding table that have in the [Switching > Filter for MAC Addresses](#) dialog the value [learned](#) in the [Status](#) column.

#### Reset ARP table

Removes the dynamically set up addresses from the ARP table.

See the [Diagnostics > System > ARP](#) dialog.

#### Clear port statistics

Resets the counter for the port statistics to 0.

See the [Basic Settings > Port](#) dialog, [Statistics](#) tab.

#### Reset IGMP snooping data

Removes the IGMP Snooping entries and resets the counter in the [Information](#) frame to 0.

See the [Switching > IGMP Snooping > Global](#) dialog.

Delete log file

Removes the logged events from the log file.

See the [Diagnostics > Report > System Log](#) dialog.

Delete persistent log file

Removes the log files from the external memory.

See the [Diagnostics > Report > Persistent Logging](#) dialog.



## 2 Time

The menu contains the following dialogs:

- ▶ Basic Settings
- ▶ SNTP
- ▶ PTP
- ▶ 802.1AS

### 2.1 Basic Settings

[Time > Basic Settings]

The device is equipped with a buffered hardware clock. This clock maintains the correct time if the power supply fails or you disconnect the device from the power supply. After the device is started, the current time is available to you, for example for log entries.

The hardware clock bridges a power supply downtime of 3 hours. The prerequisite is that the power supply of the device has been connected continually for at least 5 minutes beforehand.

In this dialog you specify time-related settings independently of the time synchronization protocol specified.

The dialog contains the following tabs:

- ▶ [Global]
- ▶ [Daylight saving time]

#### [Global]

In this tab you specify the system time in the device and the time zone.

#### Configuration

System time (UTC)

Displays the current date and time with reference to Universal Time Coordinated (UTC).

Set time from PC

The device uses the time on the PC as the system time.

System time

Displays the current date and time with reference to the local time:  $System\ time = System\ time\ (UTC) + Local\ offset\ [min] + Daylight\ saving\ time$

## Time source

Displays the time source from which the device gets the time information.

The device automatically selects the available time source with the greatest accuracy.

Possible values:

- ▶ *local*  
System clock of the device.
- ▶ *sntp*  
The *SNTP* client is activated and the device is synchronized by an *SNTP* server.
- ▶ *ptp*  
PTP is activated and the clock of the device is synchronized with a *PTP* master clock.

## Local offset [min]

Specifies the difference between the local time and *System time (UTC)* in minutes:  $Local\ offset\ [min] = System\ time - System\ time\ (UTC)$

Possible values:

- ▶ *-780..840* (default setting: *60*)

## Buttons

You find the description of the standard buttons in section “Buttons” on page 14.

## [Daylight saving time]

In this tab you activate the automatic daylight saving time function. You specify the beginning and the end of summertime using a pre-defined profile, or you specify these settings individually. During summertime, the device puts the local time forward by 1 hour.

## Operation

### Daylight saving time

Enables/disables the *Daylight saving time* mode.

Possible values:

- ▶ *On*  
The *Daylight saving time* mode is enabled.  
The device automatically changes between summertime and wintertime.
- ▶ *OFF* (default setting)  
The *Daylight saving time* mode is disabled.

The times at which the device changes between summertime and wintertime are specified in the *Summertime begin* and *Summertime end* frames.

Profile...

Displays the *Profile...* dialog. There you select a pre-defined profile for the beginning and the end of summertime. This profile overwrites the settings in the *Summertime begin* and *Summertime end* frames.

### Summertime begin

In the first 3 fields you specify the day for the beginning of summertime, and in the last field the time.

When the time in the *System time* field reaches the value entered here, the device switches to summertime.

Week

Specifies the week in the current month.

Possible values:

- ▶ *none* (default setting)
- ▶ *first*
- ▶ *second*
- ▶ *third*
- ▶ *fourth*
- ▶ *last*

Day

Specifies the day of the week.

Possible values:

- ▶ *none* (default setting)
- ▶ *Sunday*
- ▶ *Monday*
- ▶ *Tuesday*
- ▶ *Wednesday*
- ▶ *Thursday*
- ▶ *Friday*
- ▶ *Saturday*

Month

Specifies the month.

Possible values:

- ▶ *none* (default setting)
- ▶ *January*
- ▶ *February*
- ▶ *March*
- ▶ *April*
- ▶ *May*
- ▶ *June*

- ▶ *July*
- ▶ *August*
- ▶ *September*
- ▶ *October*
- ▶ *November*
- ▶ *December*

### System time

Specifies the time.

Possible values:

- ▶ `<HH:MM>` (default setting: `00:00`)

### Summertime end

In the first 3 fields you specify the day for the end of summertime, and in the last field the time.

When the time in the [System time](#) field reaches the value entered here, the device switches to wintertime.

### Week

Specifies the week in the current month.

Possible values:

- ▶ *none* (default setting)
- ▶ *first*
- ▶ *second*
- ▶ *third*
- ▶ *fourth*
- ▶ *last*

### Day

Specifies the day of the week.

Possible values:

- ▶ *none* (default setting)
- ▶ *Sunday*
- ▶ *Monday*
- ▶ *Tuesday*
- ▶ *Wednesday*
- ▶ *Thursday*
- ▶ *Friday*
- ▶ *Saturday*

## Month

Specifies the month.

Possible values:

- ▶ *none* (default setting)
- ▶ *January*
- ▶ *February*
- ▶ *March*
- ▶ *April*
- ▶ *May*
- ▶ *June*
- ▶ *July*
- ▶ *August*
- ▶ *September*
- ▶ *October*
- ▶ *November*
- ▶ *December*

## System time

Specifies the time.

Possible values:

- ▶ `<HH:MM>` (default setting: `00:00`)

### Buttons

You find the description of the standard buttons in section [“Buttons” on page 14](#).

## 2.2 SNTP

[Time > SNTP]

The Simple Network Time Protocol (SNTP) is a procedure described in the RFC 4330 for time synchronization in the network.

The device lets you synchronize the system time in the device as an *SNTP* client. As the *SNTP* server, the device makes the time information available to other devices.

The menu contains the following dialogs:

- ▶ [SNTP Client](#)
- ▶ [SNTP Server](#)



## 2.2.1 SNTP Client

[Time > SNTP > Client]

In this dialog you specify the settings with which the device operates as an *SNTP* client.

As an *SNTP* client the device obtains the time information from both *SNTP* servers and *NTP* servers and synchronizes the local clock with the time of the time server.

### Operation

Operation

Enables/disables the *SNTP Client* function of the device.

Possible values:

- ▶ *On*  
The *SNTP Client* function is enabled.  
The device operates as an *SNTP* client.
- ▶ *Off* (default setting)  
The *SNTP Client* function is disabled.

### Configuration

Mode

Specifies if the device actively requests the time information from an *SNTP* server known and configured in the network (Unicast mode) or passively waits for the time information from a random *SNTP* server (Broadcast mode).

Possible values:

- ▶ *unicast* (default setting)  
The device takes the time information only from the configured *SNTP* server. The device sends Unicast requests to the *SNTP* server and evaluates its responses.
- ▶ *broadcast*  
The device obtains the time information from one or more *SNTP* or *NTP* servers. The device evaluates the Broadcasts or Multicasts only from these servers.

#### Request interval [s]

Specifies the interval in seconds at which the device requests time information from the *SNTP* server.

Possible values:

- ▶ 5..3600 (default setting: 30)

#### Broadcast rcv timeout [s]

Specifies the time in seconds a client in broadcast client mode waits before changing the value in the field from *syncToRemoteServer* to *notSynchronized* when the client receives no broadcast packets.

Possible values:

- ▶ 128..2048 (default setting: 320)

#### Disable client after successful sync

Activates/deactivates the disabling of the *SNTP* client after the device has successfully synchronized the time.

Possible values:

- ▶ *marked*  
The disabling of the *SNTP* client is active.  
The device deactivates the *SNTP* client after successful time synchronization.
- ▶ *unmarked* (default setting)  
The disabling of the *SNTP* client is inactive.  
The *SNTP* client remains active after successful time synchronization.

## State

#### State

Displays the status of the *SNTP* client.

Possible values:

- ▶ *disabled*  
The *SNTP* client is disabled.
- ▶ *notSynchronized*  
The *SNTP* client is not synchronized with any *SNTP* or *NTP* server.
- ▶ *synchronizedToRemoteServer*  
The *SNTP* client is synchronized with an *SNTP* or *NTP* server.

## Table

In the table you specify the settings for up to 4 *SNTP* servers.

### Index

Displays the index number to which the table entry relates.

Possible values:

- ▶ 1..4

The device automatically assigns this number.

When you delete a table entry, this leaves a gap in the numbering. When you create a new table entry, the device fills the first gap.

After starting, the device sends requests to the *SNTP* server configured in the first table entry. When the server does not reply, the device sends its requests to the *SNTP* server configured in the next table entry.

If none of the configured *SNTP* servers responds in the meantime, then the *SNTP* client interrupts its synchronization. The device cyclically sends requests to each *SNTP* server until a server delivers a valid time. The device synchronizes itself with this *SNTP* server, even if the other servers can be reached again later.

### Name

Specifies the name of the *SNTP* server.

Possible values:

- ▶ Alphanumeric ASCII character string with 1..32 characters

### Address

Specifies the IP address of the *SNTP* server.

Possible values:

- ▶ Valid IPv4 address (default setting: 0.0.0.0)

### Destination UDP port

Specifies the UDP Port on which the *SNTP* server expects the time information.

Possible values:

- ▶ 1..65535 (default setting: 123)  
Exception: Port 2222 is reserved for internal functions.

### Status

Displays the connection status between the *SNTP* client and the *SNTP* server.

Possible values:

- ▶ *success*  
The device has successfully synchronized the time with the *SNTP* server.
- ▶ *badDateEncoded*  
The time information received contains protocol errors - synchronization failed.

- ▶ *other*
  - The value `0.0.0.0` is entered for the IP address of the *SNTP* server - synchronization failed.
  - or
  - The *SNTP* client is using a different *SNTP* server.
- ▶ *requestTimedOut*

The device has not received a reply from the *SNTP* server - synchronization failed.
- ▶ *serverKissOfDeath*

The *SNTP* server is overloaded. The device is requested to synchronize itself with another *SNTP* server. When no other *SNTP* server is available, the device checks at intervals longer than the setting in the *Request interval [s]* field, if the server is still overloaded.
- ▶ *serverUnsynchronized*

The *SNTP* server is not synchronized with either a local or an external reference time source - synchronization failed.
- ▶ *versionNotSupported*

The *SNTP* versions on the client and the server are incompatible with each other - synchronization failed.

#### Active

Activates/deactivates the connection to the *SNTP* server.

Possible values:

- ▶ *marked*

The connection to the *SNTP* server is activated.  
The *SNTP* client has access to the *SNTP* server.
- ▶ *unmarked* (default setting)

The connection to the *SNTP* server is deactivated.  
The *SNTP* client has no access to the *SNTP* server.

### Buttons

You find the description of the standard buttons in section “Buttons” on page 14.

## 2.2.2 SNTP Server

[Time > SNTP > Server]

In this dialog you specify the settings with which the device operates as an *SNTP* server.

The *SNTP* server provides the Universal Time Coordinated (UTC) without considering local time differences.

If the setting is appropriate, then the *SNTP* server operates in the broadcast mode. In broadcast mode, the *SNTP* server automatically sends broadcast messages or multicast messages according to the broadcast send interval.

### Operation

Operation

Enables/disables the *SNTP Server* function of the device.

Possible values:

- ▶ *On*  
The *SNTP Server* function is enabled.  
The device operates as an *SNTP* server.
- ▶ *OFF* (default setting)  
The *SNTP Server* function is disabled.

Note the setting in the *Disable server at local time source* checkbox in the *Configuration* frame.

### Configuration

UDP port

Specifies the number of the UDP port on which the *SNTP* server of the device receives requests from other clients.

Possible values:

- ▶ *1..65535* (default setting: *123*)  
Exception: Port *2222* is reserved for internal functions.

Broadcast admin mode

Activates/deactivates the Broadcast mode.

- ▶ *marked*  
The *SNTP* server replies to requests from *SNTP* clients in Unicast mode and also sends *SNTP* packets in Broadcast mode as Broadcasts or Multicasts.
- ▶ *unmarked* (default setting)  
The *SNTP* server replies to requests from *SNTP* clients in the Unicast mode.

#### Broadcast destination address

Specifies the IP address to which the *SNTP* server of the device sends the *SNTP* packets in Broadcast mode.

Possible values:

- ▶ Valid IPv4 address (default setting: 0.0.0.0)

Broadcast and Multicast addresses are permitted.

#### Broadcast UDP port

Specifies the number of the UDP port on which the *SNTP* server sends the *SNTP* packets in Broadcast mode.

Possible values:

- ▶ 1..65535 (default setting: 123)  
Exception: Port 2222 is reserved for internal functions.

#### Broadcast VLAN ID

Specifies the ID of the VLAN in which the *SNTP* server of the device sends the *SNTP* packets in Broadcast mode.

Possible values:

- ▶ 0  
The *SNTP* server sends the *SNTP* packets in the same VLAN in which the access to the device management is possible. See the *Basic Settings > Network* dialog.
- ▶ 1..4042 (default setting: 1)

#### Broadcast send interval [s]

Specifies the time interval at which the *SNTP* server of the device sends *SNTP* broadcast packets.

Possible values:

- ▶ 64..1024 (default setting: 128)

#### Disable server at local time source

Activates/deactivates the disabling of the *SNTP* server when the device is synchronized to the local clock.

Possible values:

- ▶ *marked*  
The disabling of the *SNTP* server is active.  
If the device is synchronized to the local clock, then the device disables the *SNTP* server. The *SNTP* server continues to reply to requests from *SNTP* clients. In the *SNTP* packet, the *SNTP* server informs the clients that it is synchronized locally.
- ▶ *unmarked* (default setting)  
The disabling of the *SNTP* server is inactive.  
If the device is synchronized to the local clock, then the *SNTP* server remains active.

## State

State

Displays the state of the *SNTP* server.

Possible values:

- ▶ *disabled*  
The *SNTP* server is disabled.
- ▶ *notSynchronized*  
The *SNTP* server is not synchronized with either a local or an external reference time source.
- ▶ *syncToLocal*  
The *SNTP* server is synchronized with the hardware clock of the device.
- ▶ *syncToRefclock*  
The *SNTP* server is synchronized with an external reference time source, for example PTP.
- ▶ *syncToRemoteServer*  
The *SNTP* server is synchronized with an *SNTP* server that is higher than the device in a cascade.

## Buttons

You find the description of the standard buttons in section “Buttons” on page 14.

## 2.3 PTP

[Time > PTP]

The menu contains the following dialogs:

- ▶ PTP Global
- ▶ PTP Boundary Clock
- ▶ PTP Transparent Clock

## 2.3.1 PTP Global

[Time > PTP > Global]

In this dialog you specify basic settings for the *PTP* protocol.

The Precision Time Protocol (PTP) is a procedure described in the IEEE 1588-2008 standard that supplies the devices in the network with a precise time. The method synchronizes the clocks in the network with a precision of a few 100 ns. The protocol uses Multicast communication, so the load on the network due to the *PTP* synchronization messages is negligible.

PTP is significantly more accurate than SNTP. If the *SNTP* function and the *PTP* function are enabled in the device at the same time, then the *PTP* function has priority.

With the *Best Master Clock Algorithm*, the devices in the network determine which device has the most accurate time. The devices use the device with the most accurate time as the reference time source (*Grandmaster*). Subsequently the participating devices synchronize themselves with this reference time source.

If you want to transport PTP time accurately through your network, then use only devices with PTP hardware support on the transport paths.

The protocol differentiates between the following clocks:

- ▶ *Boundary Clock (BC)*  
This clock has any number of PTP ports and operates as both *PTP* master and *PTP* slave. In its respective network segment, the clock operates as an Ordinary Clock.
  - As *PTP* slave, the clock synchronizes itself with a *PTP* master that is higher than the device in the cascade.
  - As *PTP* master, the clock forwards the time information via the network to *PTP* slaves that are higher than the device in the cascade.
- ▶ *Transparent Clock (TC)*  
This clock has any number of PTP ports. In contrast to the *Boundary Clock*, this clock corrects the time information before forwarding it, without synchronizing itself.

### Operation IEEE1588/PTP

Operation IEEE1588/PTP

Enables/disables the *PTP* function.

In the device, either the *802.1AS* function or the *PTP* function can be enabled at the same time.

Possible values:

- ▶ *On*  
The *PTP* function is enabled.  
The device synchronizes its clock with PTP.  
If the *SNTP* function and the *PTP* function are enabled in the device at the same time, then the *PTP* function has priority.
- ▶ *OFF* (default setting)  
The *PTP* function is disabled.  
The device transmits the *PTP* synchronization messages without any correction on every port.



## Configuration IEEE1588/PTP

### PTP mode

Specifies the PTP version and mode of the local clock.

Possible values:

- ▶ `v2-transparent-clock` (default setting)
- ▶ `v2-boundary-clock`

### Sync lower bound [ns]

Specifies the lower threshold value in nanoseconds for the path difference between the local clock and the reference time source (*Grandmaster*). If the path difference falls below this value once, then the local clock is classed as synchronized.

Possible values:

- ▶ `0..999999999` (default setting: 30)

### Sync upper bound [ns]

Specifies the upper threshold value in nanoseconds for the path difference between the local clock and the reference time source (*Grandmaster*). If the path difference exceeds this value once, then the local clock is classed as unsynchronized.

Possible values:

- ▶ `31..1000000000` (default setting: 5000)

### PTP management

Activates/deactivates the PTP management defined in the PTP standard.

Possible values:

- ▶ `marked`  
PTP management is activated.
- ▶ `unmarked` (default setting)  
PTP management is deactivated.

## Status

### Is synchronized

Displays if the local clock is synchronized with the reference time source (*Grandmaster*).

If the path difference between the local clock and the reference time source (*Grandmaster*) falls below the synchronization lower threshold one time, then the local clock is synchronized. This status is kept until the path difference exceeds the synchronization upper threshold one time.

You specify the synchronization thresholds in the [Configuration IEEE1588/PTP](#) frame.

Max. offset absolute [ns]

Displays the maximum path difference in nanoseconds that has occurred since the local clock was synchronized with the reference time source (*Grandmaster*).

PTP time

Displays the date and time for the PTP time scale when the local clock is synchronized with the reference time source (*Grandmaster*). Format: `Month Day, Year hh:mm:ss AM/PM`

### **Buttons**

You find the description of the standard buttons in section “Buttons” on page 14.

## **2.3.2 PTP Boundary Clock**

[Time > PTP > Boundary Clock]

With this menu you can configure the Boundary Clock mode for the local clock.

The menu contains the following dialogs:

- ▶ [PTP Boundary Clock Global](#)
- ▶ [PTP Boundary Clock Port](#)

## 2.3.2.1 PTP Boundary Clock Global

[Time > PTP > Boundary Clock > Global]

In this dialog you enter general, cross-port settings for the *Boundary Clock* mode for the local clock. The *Boundary Clock (BC)* operates according to PTP version 2 (IEEE 1588-2008).

The settings are effective when the local clock operates as the *Boundary Clock (BC)*. For this, you select in the *Time > PTP > Global* dialog in the *PTP mode* field the value *v2-boundary-clock*.

### Operation IEEE1588/PTPv2 BC

#### Priority 1

Specifies *priority 1* for the device.

Possible values:

▶ 0..255 (default setting: 128)

The *Best Master Clock Algorithm* first evaluates *priority 1* among the participating devices in order to determine the reference time source (*Grandmaster*).

The lower you set this value, the more probable it is that the device becomes the reference time source (*Grandmaster*). See the *Grandmaster* frame.

#### Priority 2

Specifies *priority 2* for the device.

Possible values:

▶ 0..255 (default setting: 128)

When the previously evaluated criteria are the same for multiple devices, the *Best Master Clock Algorithm* evaluates *priority 2* of the participating devices.

The lower you set this value, the more probable it is that the device becomes the reference time source (*Grandmaster*). See the *Grandmaster* frame.

#### Domain number

Assigns the device to a *PTP* domain.

Possible values:

▶ 0..255 (default setting: 0)

The device transmits time information from and to devices only in the same domain.

### Status IEEE1588/PTPv2 BC

#### Two step

Displays that the clock is operating in Two-Step mode.

## Steps removed

Displays the number of communication paths passed through between the local clock of the device and the reference time source (*Grandmaster*).

For a *PTP* slave, the value 1 means that the clock is connected with the reference time source (*Grandmaster*) directly through 1 communication path.

## Offset to master [ns]

Displays the measured difference (offset) between the local clock and the reference time source (*Grandmaster*) in nanoseconds. The *PTP* slave calculates the difference from the time information received.

In Two-Step mode the time information consists of 2 *PTP* synchronization messages each, which the *PTP* master sends cyclically:

- ▶ The first synchronization message (sync message) contains an estimated value for the exact sending time of the message.
- ▶ The second synchronization message (follow-up message) contains the exact sending time of the first message.

The *PTP* slave uses the two *PTP* synchronization messages to calculate the difference (offset) from the master and corrects its clock by this difference. Here the *PTP* slave also considers the *Delay to master [ns]* value.

## Delay to master [ns]

Displays the delay when transmitting the *PTP* synchronization messages from the *PTP* master to the *PTP* slave in nanoseconds.

The *PTP* slave sends a “Delay Request” packet to the *PTP* master and thus determines the exact sending time of the packet. When it receives the packet, the *PTP* master generates a time stamp and sends this in a “Delay Response” packet back to the *PTP* slave. The *PTP* slave uses the two packets to calculate the delay, and considers this starting from the next offset measurement.

The prerequisite is that the delay mechanism value of the slave ports is specified as *e2e*.

**Grandmaster**

This frame displays the criteria that the *Best Master Clock Algorithm* uses when evaluating the reference time source (*Grandmaster*).

The algorithm first evaluates *priority 1* of the participating devices. The device with the lowest value for *priority 1* is designated as the reference time source (*Grandmaster*). When the value is the same for multiple devices, the algorithm takes the next criterion, and when this is also the same, the algorithm takes the next criterion after this one. When every value is the same for multiple devices, the lowest value in the *Clock identity* field decides which device is designated as the reference time source (*Grandmaster*).

The device lets you influence which device in the network is designated as the reference time source (*Grandmaster*). To do this, modify the value in the *Priority 1* field or the *Priority 2* field in the *Operation IEEE1588/PTPv2 BC* frame.

## Priority 1

Displays *priority 1* for the device that is currently the reference time source (*Grandmaster*).

## Time

[Time > PTP > Boundary Clock > Global]

---

### Clock class

Displays the class of the reference time source (*Grandmaster*). Parameter for the *Best Master Clock Algorithm*.

### Clock accuracy

Displays the estimated accuracy of the reference time source (*Grandmaster*). Parameter for the *Best Master Clock Algorithm*.

### Clock variance

Displays the variance of the reference time source (*Grandmaster*), also known as the *Offset scaled log variance*. Parameter for the *Best Master Clock Algorithm*.

### Priority 2

Displays *priority 2* for the device that is currently the reference time source (*Grandmaster*).

## Local time properties

### Time source

Specifies the time source from which the local clock gets its time information.

Possible values:

- ▶ *atomicClock*
- ▶ *gps*
- ▶ *terrestrialRadio*
- ▶ *ptp*
- ▶ *ntp*
- ▶ *handSet*
- ▶ *other*
- ▶ *internalOscillator* (default setting)

### UTC offset [s]

Specifies the difference between the *PTP* time scale and the UTC.

See the *PTP timescale* checkbox.

Possible values:

- ▶ *-32768..32767*

**Note:** The default setting is the value valid on the creation date of the device software. You can find further information in the "Bulletin C" of the Earth Rotation and Reference Systems Service (IERS): <http://www.iers.org/iers/EN/Publications/Bulletins/bulletins.html>

#### UTC offset valid

Specifies if the value specified in the *UTC offset [s]* field is correct.

Possible values:

- ▶ `marked`
- ▶ `unmarked` (default setting)

#### Time traceable

Displays if the device gets the time from a primary UTC reference, for example from an NTP server.

Possible values:

- ▶ `marked`
- ▶ `unmarked`

#### Frequency traceable

Displays if the device gets the frequency from a primary UTC reference, for example from an NTP server.

Possible values:

- ▶ `marked`
- ▶ `unmarked`

#### PTP timescale

Displays if the device uses the PTP time scale.

Possible values:

- ▶ `marked`
- ▶ `unmarked`

According to IEEE 1588, the PTP time scale is the TAI atomic time started on 01.01.1970.

In contrast to UTC, TAI does not use leap seconds.

As of July 1, 2020, the TAI time is 37 s ahead of the UTC time.

### Identities

The device displays the identities as byte sequences in hexadecimal notation.

The identification numbers (UUID) are made up as follows:

- ▶ The device identification number consists of the MAC address of the device, with the values `ff` and `fe` added between byte 3 and byte 4.
- ▶ The port UUID consists of the device identification number followed by a 16-bit port ID.

#### Clock identity

Displays the device's own identification number (UUID).

## Time

[Time > PTP > Boundary Clock > Global]

---

### Parent port identity

Displays the port identification number (UUID) of the directly superior master device.

### Grandmaster identity

Displays the identification number (UUID) of the reference time source (*Grandmaster*) device.

## **Buttons**

You find the description of the standard buttons in section [“Buttons” on page 14](#).

## 2.3.2.2 PTP Boundary Clock Port

[Time > PTP > Boundary Clock > Port]

In this dialog you specify the *Boundary Clock (BC)* settings on each individual port.

The settings are effective when the local clock operates as the *Boundary Clock (BC)*. For this, you select in the *Time > PTP > Global* dialog in the *PTP mode* field the value *v2-boundary-clock*.

### Table

Port

Displays the port number.

PTP enable

Activates/deactivates *PTP* synchronization message transmission on the port.

Possible values:

- ▶ *marked* (default setting)  
The transmission is activated. The port forwards and receives *PTP* synchronization messages.
- ▶ *unmarked*  
The transmission is deactivated. The port blocks *PTP* synchronization messages.

PTP status

Displays the current status of the port.

Possible values:

- ▶ *initializing*  
Initialization phase
- ▶ *faulty*  
Faulty mode: error in the PTP protocol.
- ▶ *disabled*  
PTP is disabled on the port.
- ▶ *listening*  
Device port is waiting for *PTP* synchronization messages.
- ▶ *pre-master*  
*PTP* pre-master mode
- ▶ *master*  
*PTP* master mode
- ▶ *passive*  
*PTP* passive mode
- ▶ *uncalibrated*  
*PTP* uncalibrated mode
- ▶ *slave*  
*PTP* slave mode



### Sync interval

Specifies the interval in seconds at which the port transmits *PTP* synchronization messages.

Possible values:

- ▶ 0.25
- ▶ 0.5
- ▶ 1 (default setting)
- ▶ 2

### Delay mechanism

Specifies the mechanism with which the device measures the delay for transmitting the *PTP* synchronization messages.

Possible values:

- ▶ *disabled*  
The measurement of the delay for the *PTP* synchronization messages for the connected *PTP* devices is inactive.
- ▶ *e2e* (default setting)  
End-to-End: As the *PTP* slave, the port measures the delay for the *PTP* synchronization messages to the *PTP* master.  
The device displays the measured value in the *Time > PTP > Boundary Clock > Global* dialog.
- ▶ *p2p*  
Peer-to-Peer: The device measures the delay for the *PTP* synchronization messages for the connected *PTP* devices, provided that these devices support P2P.  
This mechanism saves the device from having to determine the delay again in the case of a reconfiguration.

### P2P delay

Displays the measured Peer-to-Peer delay for the *PTP* synchronization messages.

The prerequisite is that you select the value *p2p* in the *Delay mechanism* column.

### P2P delay interval [s]

Specifies the interval in seconds at which the port measures the Peer-to-Peer delay.

The prerequisite is that you have specified the value *p2p* on this port and on the port of the remote device.

Possible values:

- ▶ 1 (default setting)
- ▶ 2
- ▶ 4
- ▶ 8
- ▶ 16
- ▶ 32

## Network protocol

Specifies which protocol the port uses to transmit the *PTP* synchronization messages.

Possible values:

▶ *IEEE 802.3* (default setting)

▶ *UDP/IPv4*

If the *TSN* function is globally enabled, then on the TSN-capable port1/3, the protocol is not supported. See the *Switching > TSN > Configuration* dialog.

## Announce interval [s]

Specifies the interval in seconds at which the port transmits messages for the PTP topology discovery.

Assign the same value to every device of a *PTP* domain.

Possible values:

▶ 1

▶ 2 (default setting)

▶ 4

▶ 8

▶ 16

## Announce timeout

Specifies the number of announce intervals.

Example:

For the default setting (*Announce interval [s]* = 2 and *Announce timeout* = 3), the timeout is  $3 \times 2$  s = 6 s.

Possible values:

▶ 2..10 (default setting: 3)

Assign the same value to every device of a *PTP* domain.

## E2E delay interval [s]

Displays the interval in seconds at which the port measures the End-to-End delay:

▶ When the port is operating as the *PTP* master, the device assigns to the port the value 8.

▶ When the port is operating as the *PTP* slave, the value is specified by the *PTP* master connected to the port.

## V1 hardware compatibility

Specifies if the port adjusts the length of the *PTP* synchronization messages when you have set in the *Network protocol* column the value *udpIpv4*.

It is possible that other devices in the network expect the *PTP* synchronization messages to be the same length as PTPv1 messages.

Possible values:

- ▶ *auto* (default setting)  
The device automatically detects if other devices in the network expect the *PTP* synchronization messages to be the same length as PTPv1 messages. If this is the case, then the device extends the length of the *PTP* synchronization messages before transmitting them.
- ▶ *on*  
The device extends the length of the *PTP* synchronization messages before transmitting them.
- ▶ *off*  
The device transmits *PTP* synchronization messages without changing the length.

#### Asymmetry

Corrects the measured delay value corrupted by asymmetrical transmission paths.

Possible values:

- ▶ `-2000000000..2000000000` (default setting: 0)

The value represents the delay symmetry in nanoseconds.

A measured delay value of  $y$  ns corresponds to an asymmetry of  $y \times 2$  ns.

The value is positive if the delay from the *PTP* master to the *PTP* slave is longer than in the opposite direction.

#### VLAN

Specifies the VLAN ID with which the device marks the *PTP* synchronization messages on this port.

Possible values:

- ▶ *none* (default setting)  
The device transmits *PTP* synchronization messages without a VLAN tag.
- ▶ `0..4042`  
You specify VLANs that you have already set up in the device from the list.

Verify that the port is a member of the VLAN.

See the [Switching > VLAN > Configuration](#) dialog.

#### VLAN priority

Specifies the priority with which the device transmits the *PTP* synchronization messages marked with a VLAN ID (Layer 2, IEEE 802.1D).

Possible values:

- ▶ `0..7` (default setting: 6)

If you specified in the *VLAN* column the value *none*, then the device ignores the VLAN priority.

#### Buttons

You find the description of the standard buttons in section [“Buttons” on page 14](#).

### 2.3.3 PTP Transparent Clock

[Time > PTP > Transparent Clock]

With this menu you can configure the *Transparent Clock* mode for the local clock.

The menu contains the following dialogs:

- ▶ [PTP Transparent Clock Global](#)
- ▶ [PTP Transparent Clock Port](#)

### 2.3.3.1 PTP Transparent Clock Global

[Time > PTP > Transparent Clock > Global]

In this dialog you enter general, cross-port settings for the *Transparent Clock* mode for the local clock. The *Transparent Clock (TC)* operates according to PTP version 2 (IEEE 1588-2008).

The settings are effective when the local clock operates as the *Transparent Clock (TC)*. For this, you select in the *Time > PTP > Global* dialog in the *PTP mode* field the value `v2-transparent-clock`.

#### Operation IEEE1588/PTPv2 TC

##### Delay mechanism

Specifies the mechanism with which the device measures the delay for transmitting the *PTP* synchronization messages.

Possible values:

- ▶ `e2e` (default setting)  
As the *PTP* slave, the port measures the delay for the *PTP* synchronization messages to the *PTP* master.  
The device displays the measured value in the *Time > PTP > Transparent Clock > Global* dialog.
- ▶ `p2p`  
The device measures the delay for the *PTP* synchronization messages for every connected *PTP* device, provided that the device supports P2P.  
This mechanism saves the device from having to determine the delay again in the case of a reconfiguration.  
If you specify this value, then the value `IEEE 802.3` is only available in the *Network protocol* field.
- ▶ `e2e-optimized`  
Like `e2e`, with the following special characteristics:
  - The device transmits the delay requests of the *PTP* slaves only to the *PTP* master, even though these requests are multicast messages. The device thus spares the other devices from unnecessary multicast requests.
  - If the master-slave topology changes, then the device relearns the port for the *PTP* master as soon as it receives a synchronization message from another *PTP* master.
  - If the device does not know a *PTP* master, then the device transmits delay requests to the ports.
- ▶ `disabled`  
The delay measuring is disabled on the port. The device discards messages for the delay measuring.

##### Primary domain

Assigns the device to a *PTP* domain.

Possible values:

- ▶ `0..255` (default setting: 0)

The device transmits time information from and to devices only in the same domain.

## Network protocol

Specifies which protocol the port uses to transmit the *PTP* synchronization messages.

Possible values:

- ▶ *ieee8023* (default setting)
- ▶ *udpIpv4*

If the *TSN* function is globally enabled, then on the TSN-capable port 1/3, this protocol is not supported. See the *Switching > TSN > Configuration* dialog.

## Multi domain mode

Activates/deactivates the *PTP* synchronization message correction in every *PTP* domain.

Possible values:

- ▶ *marked*  
The device corrects *PTP* synchronization messages in every *PTP* domain.
- ▶ *unmarked* (default setting)  
The device corrects *PTP* synchronization messages only in the primary *PTP* domain. See the *Primary domain* field.

## VLAN ID

Specifies the VLAN ID with which the device marks the *PTP* synchronization messages on this port.

Possible values:

- ▶ *none* (default setting)  
The device transmits *PTP* synchronization messages without a VLAN tag.
- ▶ *0..4042*  
You specify VLANs that you have already set up in the device from the list.

## VLAN priority

Specifies the priority with which the device transmits the *PTP* synchronization messages marked with a VLAN ID (Layer 2, IEEE 802.1D).

Possible values:

- ▶ *0..7* (default setting: 6)

If you specified the value *none* in the *VLAN ID* field, then the device ignores the specified value.

**Local synchronization**

## Syntonize

Activates/deactivates the frequency synchronization of the *Transparent Clock* with the *PTP* master.

Possible values:

- ▶ *marked* (default setting)  
The frequency synchronization is active.  
The device synchronizes the frequency.
- ▶ *unmarked*  
The frequency synchronization is inactive.  
The frequency remains constant.

### Synchronize local clock

Activates/deactivates the synchronization of the local system time.

Possible values:

- ▶ `marked`  
The synchronization is active.  
The device synchronizes the local system time with the time received via PTP. The prerequisite is that the `Syntonize` checkbox is marked.
- ▶ `unmarked` (default setting)  
The synchronization is inactive.  
The local system time remains constant.

### Current master

Displays the port identification number (UUID) of the directly superior master device on which the device synchronizes its frequency.

If the value contains only zeros, this is because:

- ▶ The `Syntonize` function is disabled.  
or
- ▶ The device cannot find a `PTP` master.

### Offset to master [ns]

Displays the measured difference (offset) between the local clock and the `PTP` master in nanoseconds. The device calculates the difference from the time information received.

The prerequisite is that the `Synchronize local clock` function is enabled.

### Delay to master [ns]

Displays the delay when transmitting the `PTP` synchronization messages from the `PTP` master to the `PTP` slave in nanoseconds.

Prerequisite:

- ▶ The `Synchronize local clock` function is enabled.
- ▶ In the `Delay mechanism` field, the value `e2e` is selected.

## Status IEEE1588/PTPv2 TC

### Clock identity

Displays the device's own identification number (UUID).

The device displays the identities as byte sequences in hexadecimal notation.

The device identification number consists of the MAC address of the device, with the values `ff` and `fe` added between byte 3 and byte 4.

## **Buttons**

You find the description of the standard buttons in section [“Buttons”](#) on page 14.



### 2.3.3.2 PTP Transparent Clock Port

[Time > PTP > Transparent Clock > Port]

In this dialog you specify the *Transparent Clock (TC)* settings on each individual port.

The settings are effective when the local clock operates as the *Transparent Clock (TC)*. For this, you select in the [Time > PTP > Global](#) dialog in the *PTP mode* field the value `v2-transparent-clock`.

#### Table

Port

Displays the port number.

PTP enable

Activates/deactivates the transmitting of *PTP* synchronization messages on the port.

Possible values:

- ▶ `marked` (default setting)  
The transmitting is active.  
The port forwards and receives *PTP* synchronization messages.
- ▶ `unmarked`  
The transmitting is inactive.  
The port blocks *PTP* synchronization messages.

P2P delay interval [s]

Specifies the interval in seconds at which the port measures the Peer-to-Peer delay.

The prerequisite is that you specify the value `p2p` on this port and on the port of the remote terminal. See the [Delay mechanism](#) option list in the [Time > PTP > Transparent Clock > Global](#) dialog.

Possible values:

- ▶ `1` (default setting)
- ▶ `2`
- ▶ `4`
- ▶ `8`
- ▶ `16`
- ▶ `32`

P2P delay

Displays the measured Peer-to-Peer delay for the *PTP* synchronization messages.

The prerequisite is that you select in the [Delay mechanism](#) option list the `p2p` radio button. See the [Delay mechanism](#) field in the [Time > PTP > Transparent Clock > Global](#) dialog.

## Asymmetry

Corrects the measured delay value corrupted by asymmetrical transmission paths.

Possible values:

▶ -2000000000 .. 2000000000 (default setting: 0)

The value represents the delay symmetry in nanoseconds.

A measured delay value of  $y$  ns corresponds to an asymmetry of  $y \times 2$  ns.

The value is positive if the delay from the *PTP* master to the *PTP* slave is longer than in the opposite direction.

**Buttons**

You find the description of the standard buttons in section “Buttons” on page 14.

## 2.4 802.1AS

[Time > 802.1AS]

The *802.1AS* protocol is a procedure described in the IEEE 802.1AS-2011 standard that defines how to synchronize time accurately between devices in the network. When you use the *802.1AS* protocol over the Ethernet, you can think of the protocol as a profile of the IEEE 1588-2008 standard.

With the *Best Master Clock Algorithm*, the devices in the network determine which device has the most accurate time. The devices use the device with the most accurate time as the reference time source (*Grandmaster*). Subsequently the participating devices synchronize themselves with this reference time source.

The *802.1AS* protocol has the following specifications:

- ▶ In the device, either the *802.1AS* function or the *PTP* function can be enabled.
- ▶ If the *SNTP* function and the *802.1AS* function are enabled in the device at the same time, then the *802.1AS* function has priority.
- ▶ The *802.1AS* function supports only one domain.

The menu contains the following dialogs:

- ▶ [802.1AS Global](#)
- ▶ [802.1AS Port](#)
- ▶ [802.1AS Statistics](#)

## 2.4.1 802.1AS Global

[Time > 802.1AS > Global]

In this dialog you specify basic settings for the [802.1AS](#) protocol.

### Operation

Operation

Enables/disables the [802.1AS](#) function.

Possible values:

- ▶ [On](#)  
The [802.1AS](#) function is enabled.  
The device synchronizes its clock using the [802.1AS](#) protocol.  
Consider to activate the [802.1AS](#) protocol on the individual ports.
- ▶ [OFF](#) (default setting)  
The [802.1AS](#) function is disabled.

### Configuration

Priority 1

Specifies *priority 1* for the device.

Possible values:

- ▶ [0..255](#) (default setting: [246](#))

The *Best Master Clock Algorithm* first evaluates *priority 1* among the participating devices in order to determine the reference time source (*Grandmaster*).

The lower you set this value, the more probable it is that the device is designated as the reference time source (*Grandmaster*).

If you specify the value [255](#), then the device is not designated as the reference time source (*Grandmaster*). See the [Grandmaster](#) frame.

Priority 2

Specifies *priority 2* for the device.

Possible values:

- ▶ [0..255](#) (default setting: [248](#))

When the previously evaluated criteria are the same for multiple devices, the *Best Master Clock Algorithm* evaluates *priority 2* of the participating devices.

The lower you set this value, the more probable it is that the device is designated as the reference time source (*Grandmaster*). See the [Grandmaster](#) frame.

#### Sync lower bound [ns]

Specifies the lower threshold value in nanoseconds for the measured time difference between the local clock and the reference time source (*Grandmaster*). If the measured time difference falls below this value once, then the local clock is classed as synchronized.

Possible values:

- ▶ 0..999999999 (default setting: 30)

#### Sync upper bound [ns]

Specifies the upper threshold value in nanoseconds for the measured time difference between the local clock and the reference time source (*Grandmaster*). If the measured time difference exceeds this value once, then the local clock is classed as unsynchronized.

Possible values:

- ▶ 31..1000000000 (default setting: 5000)

#### UTC offset [s]

Displays the difference between the *802.1AS* time scale and the UTC.

#### UTC offset valid

Displays if the value displayed in the *UTC offset [s]* field is correct.

Possible values:

- ▶ *marked*
- ▶ *unmarked*

## Status

#### Offset to master [ns]

Displays the measured difference (offset) between the local clock and the reference time source (*Grandmaster*) in nanoseconds. The device calculates the difference from the time information received.

#### Max. offset absolute [ns]

Displays the maximum measured time difference in nanoseconds that has occurred since the local clock was synchronized with the reference time source (*Grandmaster*).

#### Is synchronized

Displays if the local clock is synchronized with the reference time source (*Grandmaster*).

If the measured time difference between the local clock and the reference time source (*Grandmaster*) falls below the synchronization lower threshold, then the local clock is synchronized. This status is kept until the measured time difference exceeds the synchronization upper threshold.

You specify the synchronization thresholds in the *Configuration* frame.

### Steps removed

Displays the number of communication paths passed through between the local clock of the device and the reference time source (*Grandmaster*).

For a [802.1AS](#) slave, the value [1](#) means that the clock is connected with the reference time source (*Grandmaster*) directly through 1 communication path.

### Clock identity

Displays the clock identification number of the device.

The device displays the identification number as byte sequences in hexadecimal notation.

The device identification number consists of the MAC address of the device, with the values [ff](#) and [fe](#) added between byte 3 and byte 4.

## Grandmaster

This frame displays the criteria that the *Best Master Clock Algorithm* uses when evaluating the reference time source (*Grandmaster*).

The algorithm first evaluates *priority 1* of the participating devices. The device with the lowest value for *priority 1* is designated as the reference time source (*Grandmaster*). When the value is the same for multiple devices, the algorithm takes the next criterion, and when this is also the same, the algorithm takes the next criterion after this one. When every value is the same for multiple devices, the lowest value in the [Clock identity](#) field decides which device is designated as the reference time source (*Grandmaster*).

The device lets you influence which device in the network is designated as the reference time source (*Grandmaster*). To do this, modify the value in the [Priority 1](#) field or the [Priority 2](#) field in the [Configuration](#) frame.

### Priority 1

Displays *priority 1* for the device that is currently the reference time source (*Grandmaster*).

### Clock class

Displays the class of the reference time source (*Grandmaster*). Parameter for the *Best Master Clock Algorithm*.

### Clock accuracy

Displays the estimated accuracy of the reference time source (*Grandmaster*). Parameter for the *Best Master Clock Algorithm*.

### Clock variance

Displays the variance of the reference time source (*Grandmaster*), also known as the *Offset scaled log variance*. Parameter for the *Best Master Clock Algorithm*.

### Priority 2

Displays *priority 2* for the device that is currently the reference time source (*Grandmaster*).

#### Clock identity

Displays the identification number of the reference time source (*Grandmaster*) device. The device displays the identification number as byte sequences in hexadecimal notation.

### **Parent**

#### Clock identity

Displays the port identification number of the directly superior master device. The device displays the identification number as byte sequences in hexadecimal notation.

#### Port

Displays the port number of the directly superior master device.

#### Cumulative rate ratio [ppm]

Displays the measured frequency difference of the local clock in parts per million relative to the reference time source (*Grandmaster*).

### **Buttons**

You find the description of the standard buttons in section [“Buttons” on page 14](#).

## 2.4.2 802.1AS Port

[Time > 802.1AS > Port]

In this dialog you specify the *802.1AS* settings on each individual port.

### Table

Port

Displays the port number.

Active

Activates/deactivates the *802.1AS* protocol on the port.

Possible values:

- ▶ *marked* (default setting)  
The protocol is active on the port.  
On the port, the device synchronizes its clock using the *802.1AS* protocol.  
The prerequisite is that the following protocols are not active on the port:
  - *PRP*
  - *HSR*
  - *Link Aggregation*
- ▶ *unmarked*  
The protocol is inactive on the port.

Role

Displays the current role of the port, considering the *802.1AS* protocol.

Possible values:

- ▶ *disabled*  
The port operates in the *Disabled Port* role. The port is not *802.1AS*-capable.
- ▶ *master*  
The port operates in the *Master Port* role.

- ▶ *passive*  
The port operates in the *Passive Port* role.
- ▶ *slave*  
The port operates in the *Slave Port* role.

Inspired by: IEEE Std 802.11AS-2011

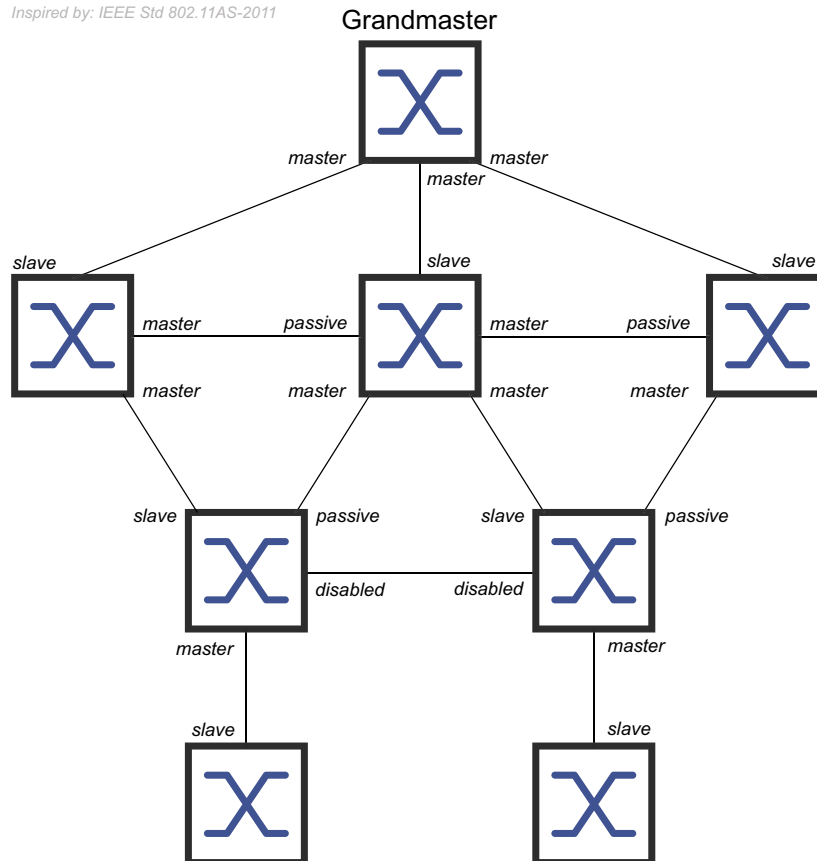

#### AS capable

Displays if the *802.1AS* protocol is active on the port.

Possible values:

- ▶ *marked*  
The *802.1AS* protocol is active on the port. The prerequisites are:
  - The port measures a *Peer delay*, the checkbox in the *Measuring delay* column is marked.
  - The value in the *Peer delay [ns]* column is lower than the value in the *Peer delay threshold [ns]* column.
- ▶ *unmarked*  
The *802.1AS* protocol is inactive on the port.

#### Announce interval [s]

Specifies the interval in seconds at which the port (in the *Master Port* role) transmits *Announce* messages for *802.1AS* topology discovery.

Possible values:

- ▶ *1..2* (default setting: *1*)  
Assign the same value to every device of a *802.1AS* domain.
- ▶ *-*  
The port does not transmit *Announce* messages.



## Announce timeout

Specifies the number of *Announce interval [s]* at which the port (in the *Slave Port* role) waits for *Announce* messages.

When the number of intervals elapses without receiving an *Announce* message, the device tries to find a new path to the reference time source using the *Best Master Clock Algorithm*. If the device finds a reference time source (*Grandmaster*), then it assigns the *Slave Port* role to the port through which the new path leads. Otherwise the device becomes the reference time source (*Grandmaster*) and assigns the *Master Port* role to its ports.

Example: In the default setting (*Announce interval [s]* = 1, *Announce timeout* = 3), the timeout is  $3 \times 1 \text{ s} = 3 \text{ s}$ .

Possible values:

- ▶ 2..10 (default setting: 3)  
Assign the same value to each port that belongs to the same *802.1AS* domain.

## Sync interval [s]

Specifies the interval in seconds at which the port (in the *Master Port* role) transmits *Sync* messages for time synchronization.

Possible values:

- ▶ 0.125 (default setting)
- ▶ 0.250
- ▶ 0.5
- ▶ 1
- ▶ -  
The port does not transmit *Sync* messages.

## Sync timeout

Specifies the number of *Sync interval [s]* at which the port (in the *Slave Port* role) waits for *Sync* messages.

When the number of intervals elapses without receiving an *Sync* message, the device tries to find a new path to the reference time source using the *Best Master Clock Algorithm*. If the device finds a reference time source (*Grandmaster*), then it assigns the *Slave Port* role to the port through which the new path leads. Otherwise the device becomes the reference time source (*Grandmaster*) and assigns the *Master Port* role to its ports.

Example: In the default setting (*Sync interval [s]* = 0.125, *Sync timeout* = 3), the timeout is  $3 \times 0.125 \text{ s} = 0.375 \text{ s}$ .

Possible values:

- ▶ 2..10 (default setting: 3)  
Assign the same value to each port that belongs to the same *802.1AS* domain.

#### Peer delay interval [s]

Specifies the interval in seconds at which the port (in the *Master Port*, *Passive Port* or *Slave Port* role) transmits a *Peer delay request* message to measure the *Peer delay*.

Possible values:

- ▶ 1 (default setting)
- ▶ 2
- ▶ 4
- ▶ 8
- ▶ -

The port does not transmit *Peer delay request* messages.

#### Peer delay timeout

Specifies the number of *Peer delay interval [s]* at which the port (in the *Master Port*, *Passive Port* or *Slave Port* role) waits for *Delay response* messages.

When the number of intervals elapses without receiving an *Delay response* message, the device assigns the *Disabled Port* role to the port. The port is no longer *802.1AS*-capable.

Possible values:

- ▶ 2..10 (default setting: 3)

#### Peer delay threshold [ns]

Specifies the upper threshold value for the *Peer delay* in nanoseconds. If the value in the *Peer delay [ns]* column is greater than this value, then the device assigns the *Disabled Port* role to the port. The port is no longer *802.1AS*-capable.

Possible values:

- ▶ 0..1000000000 (default setting: 10000)

#### Measuring delay

Displays if the port measures a *Peer delay*.

Possible values:

- ▶ *marked*  
The port measures a *Peer delay*. You find the measured value in the *Peer delay [ns]* column.
- ▶ *unmarked*  
The port does not measure a *Peer delay*.

#### Peer delay [ns]

Displays the measured *Peer delay* value in nanoseconds. The prerequisite is that the checkbox in the *Measuring delay* column is marked.

#### Neighbor rate ratio [ppm]

Displays the measured frequency difference of the local clock in parts per million relative to the clock in the adjacent device.

## **Buttons**

You find the description of the standard buttons in section [“Buttons” on page 14](#).

## 2.4.3 802.1AS Statistics

[Time > 802.1AS > Statistics]

This dialog displays information about the number of messages received, sent, or discarded on the ports. The dialog also displays counters that increment every time a timeout event occurred.

### Table

Port

Displays the port number.

Received messages

Displays the counters for messages received on the ports:

Sync messages

Displays the number of *Sync* messages.

Sync follow-up messages

Displays the number of *Sync follow-up* messages.

Delay request messages

Displays the number of *Peer delay request* messages.

Delay response messages

Displays the number of *Peer delay response* messages.

Delay response follow-up messages

Displays the number of *Peer delay response follow-up* messages.

Announce messages

Displays the number of *Announce* messages.

Discarded messages

Displays the number of *Sync* messages that the device discarded on this port. The device discards a *Sync* message for example, in cases where the port does not receive a *Sync follow-up* message for a corresponding *Sync* message.

Sync timeout

Displays the number of times that a *Sync timeout* event occurred on the port. See the *Sync timeout* column in the [Time > 802.1AS > Port](#) dialog.

### Announce timeout

Displays the number of times that an *Announce timeout* event occurred on this port. See the *Announce timeout* column in the [Time > 802.1AS > Port](#) dialog.

### Delay timeout

Displays the number of times that a *Peer delay timeout* event occurred on this port. See the *Peer delay timeout* column in the [Time > 802.1AS > Port](#) dialog.

## Transmitted messages

Displays the counters for messages transmitted on the ports:

### Sync messages

Displays the number of *Sync* messages.

### Sync follow-up messages

Displays the number of *Sync follow-up* messages.

### Delay request messages

Displays the number of *Peer delay request* messages.

### Delay response messages

Displays the number of *Peer delay response* messages.

### Delay response follow-up messages

Displays the number of *Peer delay response follow-up* messages.

### Announce messages

Displays the number of *Announce* messages.

## Buttons

You find the description of the standard buttons in section [“Buttons” on page 14](#).

## 3 Device Security

The menu contains the following dialogs:

- ▶ [User Management](#)
- ▶ [Authentication List](#)
- ▶ [Management Access](#)
- ▶ [Pre-login Banner](#)

### 3.1 User Management

[Device Security > User Management]

If users log in with valid login data, then the device lets them have access to its device management.

In this dialog you manage the users of the local user management. You also specify the following settings here:

- ▶ Settings for the login
- ▶ Settings for saving the passwords
- ▶ Specify policy for valid passwords

The methods that the device uses for the authentication you specify in the [Device Security > Authentication List](#) dialog.

#### Configuration

This frame lets you specify settings for the login.

#### Login attempts

Specifies the number of login attempts possible when the user accesses the device management using the Graphical User Interface and the Command Line Interface.

**Note:** When accessing the device management using the Command Line Interface through the serial connection, the number of login attempts is unlimited.

Possible values:

- ▶ `0..5` (default setting: `0`)

If the user makes one more unsuccessful login attempt, then the device locks access for the user.

The device lets only users with the `administrator` authorization remove the lock.

The value `0` deactivates the lock. The user has unlimited attempts to log in.

#### Login attempts period (min.)

Displays the time period before the device resets the counter in the *Login attempts* field.

Possible values:

▶ 0..60 (default setting: 0)

#### Min. password length

The device accepts the password if it contains at least the number of characters specified here.

The device checks the password according to this setting, regardless of the setting for the *Policy check* checkbox.

Possible values:

▶ 1..64 (default setting: 6)

### **Password policy**

This frame lets you specify the policy for valid passwords. The device checks every new password and password change according to this policy.

The settings effect the *Password* column. The prerequisite is that you mark the checkbox in the *Policy check* column.

#### Upper-case characters (min.)

The device accepts the password if it contains at least as many upper-case letters as specified here.

Possible values:

▶ 0..16 (default setting: 1)

The value 0 deactivates this setting.

#### Lower-case characters (min.)

The device accepts the password if it contains at least as many lower-case letters as specified here.

Possible values:

▶ 0..16 (default setting: 1)

The value 0 deactivates this setting.

#### Digits (min.)

The device accepts the password if it contains at least as many numbers as specified here.

Possible values:

▶ 0..16 (default setting: 1)

The value 0 deactivates this setting.

#### Special characters (min.)

The device accepts the password if it contains at least as many special characters as specified here.

Possible values:

- ▶ 0..16 (default setting: 1)

The value 0 deactivates this setting.

### Table

Every user requires an active user account to gain access to the device management. The table lets you set up and manage user accounts.

To change settings, click the desired parameter in the table and modify the value.

#### User name

Displays the name of the user account.

To create a new user account, click the  button.

#### Active

Activates/deactivates the user account.

Possible values:

- ▶ *marked*  
The user account is active. The device accepts the login of a user with this user name.
- ▶ *unmarked* (default setting)  
The user account is inactive. The device rejects the login of a user with this user name.

When one user account exists with the *administrator* access role, this user account is constantly active.

#### Password

Specifies the password that the user applies to access the device management using the Graphical User Interface or Command Line Interface.

Displays \*\*\*\*\* (asterisks) instead of the password with which the user logs in. To change the password, click the relevant field.

When you specify the password for the first time, the device uses the same password in the *SNMP auth password* and *SNMP encryption password* columns.

- The device lets you specify different passwords in the *SNMP auth password* and *SNMP encryption password* columns.
- If you change the password in the current column, then the device also changes the passwords for the *SNMP auth password* and *SNMP encryption password* columns, but only if they are not individually specified previously.

Possible values:

- ▶ Alphanumeric ASCII character string with 6..64 characters  
The following characters are allowed:



- a..z
- A..Z
- 0..9
- !#\$%&'()\*+,-./:;<=>?@[\\]^\_`{|}~

The minimum length of the password is specified in the [Configuration](#) frame. The device differentiates between upper and lower case.

If the checkbox in the [Policy check](#) column is marked, then the device checks the password according to the policy specified in the [Password policy](#) frame.

The device constantly checks the minimum length of the password, even if the checkbox in the [Policy check](#) column is *unmarked*.

## Role

Specifies the user role that regulates the access of the user to the individual functions of the device.

Possible values:

- ▶ [unauthorized](#)  
The user is blocked, and the device rejects the user login. Assign this value to temporarily lock the user account. If the device detects an error when another role is being assigned, then the device assigns this role to the user account.
- ▶ [guest](#) (default setting)  
The user is authorized to monitor the device.
- ▶ [auditor](#)  
The user is authorized to monitor the device and to save the log file in the [Diagnostics > Report > Audit Trail](#) dialog.
- ▶ [operator](#)  
The user is authorized to monitor the device and to change the settings – with the exception of security settings for device access.
- ▶ [administrator](#)  
The user is authorized to monitor the device and to change the settings.

The device assigns the Service Type transferred in the response of a RADIUS server as follows to a user role:

- Administrative-User: [administrator](#)
- Login-User: [operator](#)
- NAS-Prompt-User: [guest](#)

## User locked

Unlocks the user account.

Possible values:

- ▶ [marked](#)  
The user account is locked. The user has no access to the device management. If the user makes too many unsuccessful login attempts, then the device automatically locks the user.
- ▶ [unmarked](#) (grayed out) (default setting)  
The user account is unlocked. The user has access to the device management.

#### Policy check

Activates/deactivates the password check.

Possible values:

- ▶ `marked`  
The password check is activated.  
When you set up or change the password, the device checks the password according to the policy specified in the [Password policy](#) frame.
- ▶ `unmarked` (default setting)  
The password check is deactivated.

#### SNMP auth type

Specifies the authentication protocol that the device applies for user access via SNMPv3.

Possible values:

- ▶ `hmacmd5` (default value)  
For this user account, the device uses protocol HMACMD5.
- ▶ `hmacsha`  
For this user account, the device uses protocol HMACSHA.

#### SNMP auth password

Specifies the password that the device applies for user access via SNMPv3.

Displays \*\*\*\*\* (asterisks) instead of the password with which the user logs in. To change the password, click the relevant field.

By default, the device uses the same password that you specify in the [Password](#) column.

- For the current column, the device lets you specify a different password than in the [Password](#) column.
- If you change the password in the [Password](#) column, then the device also changes the password for the current column, but only if it is not individually specified.

Possible values:

- ▶ Alphanumeric ASCII character string with 6..64 characters  
The following characters are allowed:
  - `a..z`
  - `A..Z`
  - `0..9`
  - `!#$%&'()*+,-./:;<=>?@[\\]^_`{|}~`

#### SNMP encryption type

Specifies the encryption protocol that the device applies for user access via SNMPv3.

Possible values:

- ▶ `none`  
No encryption.
- ▶ `des` (default value)  
DES encryption
- ▶ `aesCfb128`  
AES128 encryption

### SNMP encryption password

Specifies the password that the device applies to encrypt user access via SNMPv3.

Displays \*\*\*\*\* (asterisks) instead of the password with which the user logs in. To change the password, click the relevant field.

By default, the device uses the same password that you specify in the *Password* column.

- For the current column, the device lets you specify a different password than in the *Password* column.
- If you change the password in the *Password* column, then the device also changes the password for the current column, but only if it is not individually specified.

Possible values:

- ▶ Alphanumeric ASCII character string with 6..64 characters

The following characters are allowed:

- a..z
- A..Z
- 0..9
- !#\$%&'()\*+,-./:;<=>?@[\\]^\_`{|}~

### Buttons

You find the description of the standard buttons in section “Buttons” on page 14.



Opens the *Create* window to add a new entry to the table.

- ▶ In the *User name* field, you specify the name of the user account.

Possible values:

- Alphanumeric ASCII character string with 1..32 characters

## 3.2 Authentication List

[Device Security > Authentication List]

In this dialog you manage the authentication lists. In an authentication list you specify which method the device uses for the authentication. You also have the option to assign pre-defined applications to the authentication lists.

If users log in with valid login data, then the device lets them have access to its device management. The device authenticates the users using the following methods:

- ▶ User management of the device
- ▶ RADIUS

With the port-based access control according to IEEE 802.1X, if connected end devices log in with valid login data, then the device lets them have access to the network. The device authenticates the end devices using the following methods:

- ▶ RADIUS
- ▶ IAS (Integrated Authentication Server)

In the default setting the following authentication lists are available:

- ▶ `defaultDot1x8021AuthList`
- ▶ `defaultLoginAuthList`
- ▶ `defaultV24AuthList`

### Table

**Note:** If the table does not contain a list, then the access to the device management is only possible using the Command Line Interface through the serial interface of the device. In this case, the device authenticates the user by using the local user management. See the [Device Security > User Management](#) dialog.

Name

Displays the name of the list.

To create a new list, click the  button.

Possible values:

- ▶ Alphanumeric ASCII character string with 1..32 characters

Policy 1  
 Policy 2  
 Policy 3  
 Policy 4  
 Policy 5

Specifies the authentication policy that the device uses for access using the application specified in the [Dedicated applications](#) column.

The device gives you the option of a fall-back solution. For this, you specify another policy in each of the policy fields. If the authentication with the specified policy is unsuccessful, then the device can use the next policy, depending on the order of the values entered in each policy.

Possible values:

- ▶ *local* (default setting)  
The device authenticates the users by using the local user management. See the [Device Security > User Management](#) dialog.  
You cannot assign this value to the authentication list `defaultDot1x8021AuthList`.
- ▶ *radius*  
The device authenticates the users with a RADIUS server in the network. You specify the RADIUS server in the [Network Security > RADIUS > Authentication Server](#) dialog.
- ▶ *reject*  
The device accepts or rejects the authentication depending on which policy you try first. The following list contains authentication scenarios:
  - If the first policy in the authentication list is *local* and the device accepts the login credentials of the user, then it logs the user in without attempting the other policies.
  - If the first policy in the authentication list is *local* and the device denies the login credentials of the user, then it attempts to log the user in using the other policies in the order specified.
  - If the first policy in the authentication list is *radius* and the device rejects a login, then the login is immediately rejected without attempting to log in the user using another policy.  
If there is no response from the RADIUS server, then the device attempts to authenticate the user with the next policy.
  - If the first policy in the authentication list is *reject*, then the devices immediately rejects the user login without attempting another policy.
  - Verify that the authentication list `defaultV24AuthList` contains at least one policy different from *reject*.
- ▶ *ias*  
The device authenticates the end devices logging in via 802.1X with the integrated authentication server (IAS). The integrated authentication server manages the login data in a separate database. See the [Network Security > 802.1X Port Authentication > Integrated Authentication Server](#) dialog.  
You can only assign this value to the authentication list `defaultDot1x8021AuthList`.

#### Dedicated applications

Displays the dedicated applications. When users access the device with the relevant application, the device uses the specified policies for the authentication.

To allocate another application to the list or remove the allocation, click the  button and then the [Allocate applications](#) item. The device lets you assign each application to exactly one list.

#### Active

Activates/deactivates the list.

Possible values:

- ▶ *marked*  
The list is activated. The device uses the policies in this list when users access the device with the relevant application.
- ▶ *unmarked* (default setting)  
The list is deactivated.

## Buttons

You find the description of the standard buttons in section [“Buttons” on page 14](#).

### Allocate applications

Opens the *Allocate applications* window.

- ▶ The left field displays the applications that can be allocated to the highlighted list.
- ▶ The right field displays the applications that are allocated to the highlighted list.
- ▶ Buttons:
  - Moves every entry to the right field.
  - ➡ Moves the highlighted entries from the left field to the right field.
  - ➠ Moves the highlighted entries from the right field to the left field.
  - ◀ Moves every entry to the left field.

**Note:** When you move the entry `WebInterface` to the left field, the connection to the device is lost, after you click the *Ok* button.

### 3.3 Management Access

[Device Security > Management Access]

The menu contains the following dialogs:

- ▶ [Server](#)
- ▶ [IP Access Restriction](#)
- ▶ [Web](#)
- ▶ [Command Line Interface](#)
- ▶ [SNMPv1/v2 Community](#)

### 3.3.1 Server

[Device Security > Management Access > Server]

This dialog lets you set up the server services which enable users or applications to access the management of the device.

The dialog contains the following tabs:

- ▶ [Information]
- ▶ [SNMP]
- ▶ [Telnet]
- ▶ [SSH]
- ▶ [HTTP]
- ▶ [HTTPS]

#### [Information]

This tab displays as an overview which server services are enabled.

#### Table

##### SNMPv1

Displays if the server service is active or inactive, which authorizes access to the device using SNMP version 1. See the [SNMP](#) tab.

Possible values:

- ▶ `marked`  
Server service is active.
- ▶ `unmarked`  
Server service is inactive.

##### SNMPv2

Displays if the server service is active or inactive, which authorizes access to the device using SNMP version 2. See the [SNMP](#) tab.

Possible values:

- ▶ `marked`  
Server service is active.
- ▶ `unmarked`  
Server service is inactive.



### SNMPv3

Displays if the server service is active or inactive, which authorizes access to the device using SNMP version 3. See the [SNMP](#) tab.

Possible values:

- ▶ [marked](#)  
Server service is active.
- ▶ [unmarked](#)  
Server service is inactive.

### Telnet server

Displays if the server service is active or inactive, which authorizes access to the device using Telnet. See the [Telnet](#) tab.

Possible values:

- ▶ [marked](#)  
Server service is active.
- ▶ [unmarked](#)  
Server service is inactive.

### SSH server

Displays if the server service is active or inactive, which authorizes access to the device using Secure Shell. See the [SSH](#) tab.

Possible values:

- ▶ [marked](#)  
Server service is active.
- ▶ [unmarked](#)  
Server service is inactive.

### HTTP server

Displays if the server service is active or inactive, which authorizes access to the device using the Graphical User Interface through HTTP. See the [HTTP](#) tab.

Possible values:

- ▶ [marked](#)  
Server service is active.
- ▶ [unmarked](#)  
Server service is inactive.

### HTTPS server

Displays if the server service is active or inactive, which authorizes access to the device using the Graphical User Interface through HTTPS. See the [HTTPS](#) tab.

Possible values:

- ▶ [marked](#)  
Server service is active.
- ▶ [unmarked](#)  
Server service is inactive.

## Buttons

You find the description of the standard buttons in section [“Buttons” on page 14](#).

## [SNMP]

This tab lets you specify settings for the SNMP agent of the device and to enable/disable access to the device with different SNMP versions.

The SNMP agent enables access to the device management with SNMP-based applications.

## Configuration

### SNMPv1

Activates/deactivates the access to the device with SNMP version 1.

Possible values:

- ▶ `marked` (default setting)  
Access is activated.
- ▶ `unmarked`  
Access is deactivated.

You specify the community names in the [Device Security > Management Access > SNMPv1/v2 Community](#) dialog.

### SNMPv2

Activates/deactivates the access to the device with SNMP version 2.

Possible values:

- ▶ `marked` (default setting)  
Access is activated.
- ▶ `unmarked`  
Access is deactivated.

You specify the community names in the [Device Security > Management Access > SNMPv1/v2 Community](#) dialog.

### SNMPv3

Activates/deactivates the access to the device with SNMP version 3.

Possible values:

- ▶ `marked` (default setting)  
Access is activated.
- ▶ `unmarked`  
Access is deactivated.

Network management systems like Industrial HiVision use this protocol to communicate with the device.



### UDP port

Specifies the number of the UDP port on which the SNMP agent receives requests from clients.

Possible values:

- ▶ [1..65535](#) (default setting: [161](#))  
Exception: Port [2222](#) is reserved for internal functions.

To enable the SNMP agent to use the new port after a change, you proceed as follows:

- Click the  button.
- Select in the [Basic Settings > Load/Save](#) dialog the active configuration profile.
- Click the  button to save the current changes.
- Restart the device.

### SNMPover802

Activates/deactivates the access to the device through SNMP over IEEE-802.

Possible values:

- ▶ [marked](#)  
Access is activated.
- ▶ [unmarked](#) (default setting)  
Access is deactivated.

### Buttons

You find the description of the standard buttons in section [“Buttons” on page 14](#).

## [Telnet]

This tab lets you enable/disable the Telnet server in the device and specify its settings.

The Telnet server enables access to the device management remotely through the Command Line Interface. Telnet connections are unencrypted.

### Operation

#### Operation

Enables/disables the Telnet server.

Possible values:

- ▶ [On](#) (default setting)  
The Telnet server is enabled.  
The access to the device management is possible through the Command Line Interface using an unencrypted Telnet connection.
- ▶ [Off](#)  
The Telnet server is disabled.

**Note:** If the *SSH* server is disabled and you also disable the *Telnet* server, then the access to the Command Line Interface is only possible through the serial interface of the device.

## Configuration

### TCP port

Specifies the number of the TCP port on which the device receives Telnet requests from clients.

Possible values:

- ▶ 1..65535 (default setting: 23)  
Exception: Port 2222 is reserved for internal functions.

The server restarts automatically after the port is changed. Existing connections remain in place.

### Connections

Displays how many Telnet connections are currently established to the device.

### Connections (max.)

Specifies the maximum number of Telnet connections to the device that can be set up simultaneously.

Possible values:

- ▶ 1..5 (default setting: 5)

### Session timeout [min]

Specifies the timeout in minutes. After the device has been inactive for this time it ends the session for the user logged in.

A change in the value takes effect the next time a user logs in.

Possible values:

- ▶ 0  
Deactivates the function. The connection remains established in the case of inactivity.
- ▶ 1..160 (default setting: 5)

## Buttons

You find the description of the standard buttons in section [“Buttons” on page 14](#).

## [SSH]

This tab lets you enable/disable the SSH server in the device and specify its settings required for SSH. The server works with SSH version 2.

The SSH server enables access to the device management remotely through the Command Line Interface. SSH connections are encrypted.

The SSH server identifies itself to the clients using its public RSA key. When first setting up the connection, the client program displays the user the fingerprint of this key. The fingerprint contains a Base64-coded character sequence that is easy to check. When you make this character sequence available to the users via a reliable channel, they have the option to compare both fingerprints. If the character sequences match, then the client is connected to the correct server.

The device lets you create the private and public keys (host keys) required for RSA directly in the device. Otherwise you have the option to copy your own keys to the device in PEM format.

As an alternative, the device lets you load the RSA key (host key) from an external memory upon restart. You activate this function in the [Basic Settings > External Memory](#) dialog, [SSH key auto upload](#) column.

### Operation

#### Operation

Enables/disables the SSH server.

Possible values:

- ▶ *On* (default setting)  
The SSH server is enabled.  
The access to the device management is possible through the Command Line Interface using an encrypted SSH connection.  
You can start the server only if there is an RSA signature in the device.
- ▶ *Off*  
The SSH server is disabled.  
When you disable the SSH server, the existing connections remain established. However, the device helps prevent new connections from being set up.

**Note:** If the Telnet server is disabled and you also disable SSH, then the access to the Command Line Interface is only possible through the serial interface of the device.

### Configuration

#### TCP port

Specifies the number of the TCP port on which the device receives SSH requests from clients.

Possible values:

- ▶ *1..65535* (default setting: *22*)  
Exception: Port *2222* is reserved for internal functions.

The server restarts automatically after the port is changed. Existing connections remain in place.

### Sessions

Displays how many SSH connections are currently established to the device.

### Sessions (max.)

Specifies the maximum number of SSH connections to the device that can be set up simultaneously.

Possible values:

- ▶ 1..5 (default setting: 5)

### Session timeout [min]

Specifies the timeout in minutes. After the user logged in has been inactive for this time, the device ends the connection.

A change in the value takes effect the next time a user logs in.

Possible values:

- ▶ 0  
Deactivates the function. The connection remains established in the case of inactivity.
- ▶ 1..160 (default setting: 5)

## Fingerprint

The fingerprint is an easy to verify string that uniquely identifies the host key of the SSH server.

After importing a new host key, the device continues to display the existing fingerprint until you restart the server.

### Fingerprint type

Specifies which fingerprint the *RSA Fingerprint* field displays.

Possible values:

- ▶ *md5*  
The *RSA Fingerprint* field displays the fingerprint as hexadecimal MD5 hash.
- ▶ *sha256*  
The *RSA Fingerprint* field displays the fingerprint as Base64-coded SHA256 hash.

### RSA Fingerprint

Displays the fingerprint of the public host key of the SSH server.

When you change the settings in the *Fingerprint type* field, click afterwards the  button and then the  button to update the display.

## Signature

### RSA present

Displays if an RSA host key is present in the device.

Possible values:

- ▶ [marked](#)  
A key is present.
- ▶ [unmarked](#)  
No key is present.

### Create

Generates a host key in the device. The prerequisite is that the [SSH](#) server is disabled.

Length of the key created:

- ▶ 2048 bit (RSA)

To get the SSH server to use the generated host key, re-enable the SSH server.

Alternatively, you have the option to copy your own host key to the device in PEM format. See the [Key import](#) frame.

### Delete

Removes the host key from the device. The prerequisite is that the SSH server is disabled.

### Oper status

Displays if the device currently generates a host key.

It is possible that another user triggered this action.

Possible values:

- ▶ [rsa](#)  
The device currently generates an RSA host key.
- ▶ [none](#)  
The device does not generate a host key.

## Key import

### URL

Specifies the path and file name of your own RSA host key.

The device accepts the RSA key if it has the following key length:

- 2048 bit (RSA)

The device gives you the following options for copying the key to the device:

▶ Import from the PC

When the host key is located on your PC or on a network drive, drag and drop the file that contains the key in the  area. Alternatively click in the area to select the file.

▶ Import from an FTP server

When the key is on an FTP server, specify the URL for the file in the following form:  
ftp://<user>:<password>@<IP address>:<port>/<file name>

▶ Import from a TFTP server

When the key is on a TFTP server, specify the URL for the file in the following form:  
tftp://<IP address>/<path>/<file name>

▶ Import from an SCP or SFTP server

When the key is on an SCP or SFTP server, specify the URL for the file in the following form:

- scp:// or sftp://<IP address>/<path>/<file name>

When you click the [Start](#) button, the device displays the [Credentials](#) window. There you enter [User name](#) and [Password](#), to log in to the server.

- scp://<user>:<password>@<IP address>/<path>/<file name>

### Start

Copies the key specified in the [URL](#) field to the device.

## Buttons

You find the description of the standard buttons in section [“Buttons” on page 14](#).

## [HTTP]

This tab lets you enable/disable the HTTP protocol for the web server and specify the settings required for HTTP.

The web server provides the Graphical User Interface via an unencrypted HTTP connection. For security reasons, disable the HTTP protocol and use the HTTPS protocol instead.

The device supports up to 10 simultaneous connections using HTTP or HTTPS.

**Note:** If you change the settings in this tab and click the  button, then the device ends the session and disconnects every opened connection. To continue working with the Graphical User Interface, log in again.



## Operation

### Operation

Enables/disables the [HTTP](#) protocol for the web server.

Possible values:

- ▶ [On](#) (default setting)  
The [HTTP](#) protocol is enabled.  
The access to the device management is possible through an unencrypted [HTTP](#) connection.  
When the [HTTPS](#) protocol is also enabled, the device automatically redirects the request for a [HTTP](#) connection to an encrypted [HTTPS](#) connection.
- ▶ [Off](#)  
The [HTTP](#) protocol is disabled.  
When the [HTTPS](#) protocol is enabled, the access to the device management is possible through an encrypted [HTTPS](#) connection.

**Note:** If the [HTTP](#) and [HTTPS](#) protocols are disabled, then you can enable the [HTTP](#) protocol using the Command Line Interface command `http server` to get to the Graphical User Interface.

## Configuration

### TCP port

Specifies the number of the TCP port on which the web server receives HTTP requests from clients.

Possible values:

- ▶ [1..65535](#) (default setting: [80](#))  
Exception: Port [2222](#) is reserved for internal functions.

## Buttons

You find the description of the standard buttons in section “[Buttons](#)” on page 14.

## [HTTPS]

This tab lets you enable/disable the HTTPS protocol for the web server and specify the settings required for HTTPS.

The web server provides the Graphical User Interface via an encrypted HTTP connection.

A digital certificate is required for the encryption of the HTTP connection. The device lets you create this certificate yourself or to load an existing certificate onto the device.

The device supports up to 10 simultaneous connections using HTTP or HTTPS.

**Note:** If you change the settings in this tab and click the  button, then the device ends the session and disconnects every opened connection. To continue working with the Graphical User Interface, log in again.

## Operation

### Operation

Enables/disables the [HTTPS](#) protocol for the web server.

Possible values:

- ▶ [On](#) (default setting)  
The [HTTPS](#) protocol is enabled.  
The access to the device management is possible through an encrypted [HTTPS](#) connection.  
When there is no digital certificate present, the device generates a digital certificate before it enables the [HTTPS](#) protocol.
- ▶ [Off](#)  
The [HTTPS](#) protocol is disabled.  
When the [HTTP](#) protocol is enabled, the access to the device management is possible through an unencrypted [HTTP](#) connection.

**Note:** If the [HTTP](#) and [HTTPS](#) protocols are disabled, then you can enable the [HTTPS](#) protocol using the Command Line Interface command `https server` to get to the Graphical User Interface.

## Configuration

### TCP port

Specifies the number of the TCP port on which the web server receives HTTPS requests from clients.

Possible values:

- ▶ [1..65535](#) (default setting: [443](#))  
Exception: Port [2222](#) is reserved for internal functions.

## Fingerprint

The fingerprint is an easily verified hexadecimal number sequence that uniquely identifies the digital certificate of the HTTPS server.

After importing a new digital certificate, the device displays the current fingerprint until you restart the server.

### Fingerprint type

Specifies which fingerprint the *Fingerprint* field displays.

Possible values:

- ▶ *sha1*  
The *Fingerprint* field displays the SHA1 fingerprint of the certificate.
- ▶ *sha256*  
The *Fingerprint* field displays the SHA256 fingerprint of the certificate.

### Fingerprint

Character sequence of the digital certificate used by the server.

When you change the settings in the *Fingerprint type* field, click afterwards the  button and then the  button to update the display.

### Certificate

**Note:** If the device uses a certificate that is not signed by a certification authority, then the web browser displays a message while loading the Graphical User Interface. To continue, add an exception rule for the certificate in the web browser.

### Present

Displays if the digital certificate is present in the device.

Possible values:

- ▶ *marked*  
The certificate is present.
- ▶ *unmarked*  
The certificate has been removed.

### Create

Generates a digital certificate in the device.

Until restarting the web server uses the previous certificate.

To get the web server to use the newly generated certificate, restart the web server. Restarting the web server is possible only through the Command Line Interface.

Alternatively, you have the option of copying your own certificate to the device. See the *Certificate import* frame.

### Delete

Deletes the digital certificate.

Until restarting the web server uses the previous certificate.

Oper status

Displays if the device currently generates or deletes a digital certificate.

It is possible that another user has triggered the action.

Possible values:

- ▶ *none*  
The device does currently not generate or delete a certificate.
- ▶ *delete*  
The device currently deletes a certificate.
- ▶ *generate*  
The device currently generates a certificate.

### Certificate import

URL

Specifies the path and file name of the certificate.

The device accepts certificates with the following properties:

- X.509 format
- .PEM file name extension
- Base64-coded, enclosed by
 

```
-----BEGIN PRIVATE KEY-----
and
-----END PRIVATE KEY-----
as well as
-----BEGIN CERTIFICATE-----
and
-----END CERTIFICATE-----
```
- RSA key with 2048 bit length

The device gives you the following options for copying the certificate to the device:

- ▶ Import from the PC  
When the certificate is located on your PC or on a network drive, drag and drop the certificate in the  area. Alternatively click in the area to select the certificate.
- ▶ Import from an FTP server  
When the certificate is on a FTP server, specify the URL for the file in the following form:  
ftp://<user>:<password>@<IP address>:<port>/<path>/<file name>
- ▶ Import from a TFTP server  
When the certificate is on a TFTP server, specify the URL for the file in the following form:  
tftp://<IP address>/<path>/<file name>
- ▶ Import from an SCP or SFTP server  
When the certificate is on an SCP or SFTP server, specify the URL for the file in the following form:  
– scp:// or sftp://<IP address>/<path>/<file name>  
When you click the *Start* button, the device displays the *Credentials* window. There you enter *User name* and *Password*, to log in to the server.  
– scp:// or sftp://<user>:<password>@<IP address>/<path>/<file name>

Start

Copies the certificate specified in the [URL](#) field to the device.

### **Buttons**

You find the description of the standard buttons in section [“Buttons” on page 14](#).

## 3.3.2 IP Access Restriction

[Device Security > Management Access > IP Access Restriction]

This dialog enables you to restrict the access to the device management to specific IP address ranges and selected IP-based applications.

- ▶ If the function is disabled, then the access to the device management is possible from any IP address and using every application.
- ▶ If the function is enabled, then the access is restricted. You have access to the device management only under the following conditions:
  - At least one table entry is activated.  
and
  - You are accessing the device with a permitted application from a permitted IP address range.

### Operation

**Note:** Before you enable the function, verify that at least one active entry in the table lets you access. Otherwise, if you change the settings, then the connection to the device terminates. The access to the device management is possible only using the Command Line Interface through the serial interface.

#### Operation

Enables/disables the *IP Access Restriction* function.

Possible values:

- ▶ *On*  
The *IP Access Restriction* function is enabled.  
The access to the device management is restricted.
- ▶ *Off* (default setting)  
The *IP Access Restriction* function is disabled.

### Table

You have the option of defining up to 16 table entries and activating them separately.

#### Index

Displays the index number to which the table entry relates.

When you delete a table entry, this leaves a gap in the numbering. When you create a new table entry, the device fills the first gap.

Possible values:

- ▶ 1..16

### Address

Specifies the IP address of the network from which you allow the access to the device management. You specify the network range in the *Netmask* column.

Possible values:

- ▶ Valid IPv4 address (default setting: 0.0.0.0)

### Netmask

Specifies the range of the network specified in the *Address* column.

Possible values:

- ▶ Valid netmask (default setting: 0.0.0.0)

### HTTP

Activates/deactivates the HTTP access.

Possible values:

- ▶ *marked* (default setting)  
Access is activated for the adjacent IP address range.
- ▶ *unmarked*  
Access is deactivated.

### HTTPS

Activates/deactivates the HTTPS access.

Possible values:

- ▶ *marked* (default setting)  
Access is activated for the adjacent IP address range.
- ▶ *unmarked*  
Access is deactivated.

### SNMP

Activates/deactivates the SNMP access.

Possible values:

- ▶ *marked* (default setting)  
Access is activated for the adjacent IP address range.
- ▶ *unmarked*  
Access is deactivated.

## Telnet

Activates/deactivates the Telnet access.

Possible values:

- ▶ `marked` (default setting)  
Access is activated for the adjacent IP address range.
- ▶ `unmarked`  
Access is deactivated.

## SSH

Activates/deactivates the SSH access.

Possible values:

- ▶ `marked` (default setting)  
Access is activated for the adjacent IP address range.
- ▶ `unmarked`  
Access is deactivated.

## IEC61850-MMS

Activates/deactivates the access to the MMS server.

Possible values:

- ▶ `marked` (default setting)  
Access is activated for the adjacent IP address range.
- ▶ `unmarked`  
Access is deactivated.

## Modbus TCP

Activates/deactivates the access to the *Modbus TCP* server.

Possible values:

- ▶ `marked` (default setting)  
Access is activated for the adjacent IP address range.
- ▶ `unmarked`  
Access is deactivated.

## EtherNet/IP

Activates/deactivates the access to the *EtherNet/IP* server.

Possible values:

- ▶ `marked` (default setting)  
Access is activated for the adjacent IP address range.
- ▶ `unmarked`  
Access is deactivated.



### PROFINET

Activates/deactivates the access to the *PROFINET* server.

Possible values:

- ▶ *marked* (default setting)  
Access is activated for the adjacent IP address range.
- ▶ *unmarked*  
Access is deactivated.

### Active

Activates/deactivates the table entry.

Possible values:

- ▶ *marked* (default setting)  
Table entry is activated. The device restricts the access to the device management to the adjacent IP address range and the selected IP-based applications.
- ▶ *unmarked*  
Table entry is deactivated.

### Buttons

You find the description of the standard buttons in section [“Buttons” on page 14](#).

### 3.3.3 Web

[Device Security > Management Access > Web]

In this dialog you specify settings for the Graphical User Interface.

#### Configuration

Web interface session timeout [min]

Specifies the timeout in minutes. After the device has been inactive for this time it ends the session for the user logged in.

Possible values:

▶ 0..160 (default setting: 5)

The value 0 deactivates the function, and the user remains logged in when inactive.

#### Buttons

You find the description of the standard buttons in section [“Buttons” on page 14](#).

### 3.3.4 Command Line Interface

[Device Security > Management Access > CLI]

In this dialog you specify settings for the Command Line Interface. You find detailed information about the Command Line Interface in the “Command Line Interface” reference manual.

The dialog contains the following tabs:

- ▶ [Global]
- ▶ [Login banner]

#### [Global]

This tab lets you change the prompt in the Command Line Interface and specify the automatic closing of sessions through the serial interface when they have been inactive.

The device has the following serial interfaces.

- ▶ V.24 interface

#### Configuration

##### Login prompt

Specifies the character string that the device displays in the Command Line Interface at the start of every command line.

Possible values:

- ▶ Alphanumeric ASCII character string with 0..128 characters (0x20..0x7E) including space characters
- Wildcards
- %d date
  - %i IP address
  - %m MAC address
  - %p product name
  - %t time
- Default setting: (RSPE)

Changes to this setting are immediately effective in the active Command Line Interface session.

##### Serial interface timeout [min]

Specifies the time in minutes after which the device automatically closes the session of an inactive user logged in with the Command Line Interface through the serial interface.

Possible values:

- ▶ 0..160 (default setting: 5)
- The value 0 deactivates the function, and the user remains logged in when inactive.

A change in the value takes effect the next time a user logs in.

For the *Telnet* server and the *SSH* server, you specify the timeout in the *Device Security > Management Access > Server* dialog.

## Buttons

You find the description of the standard buttons in section “Buttons” on page 14.

### [Login banner]

In this tab you replace the start screen of the Command Line Interface with your own text.

In the default setting, the start screen displays information about the device, such as the software version and the device settings. With the function in this tab, you deactivate this information and replace it with an individually specified text.

To display your own text in the Command Line Interface and in the Graphical User Interface before the login, you use the *Device Security > Pre-login Banner* dialog.

## Operation

### Operation

Enables/disables the *Login banner* function.

Possible values:

- ▶ *On*  
The *Login banner* function is enabled.  
The device displays the text information specified in the *Banner text* field to the users that log in with the Command Line Interface.
- ▶ *Off* (default setting)  
The *Login banner* function is disabled.  
The start screen displays information about the device. The text information in the *Banner text* field is kept.

## Banner text

### Banner text

Specifies the character string that the device displays in the Command Line Interface at the start of every session.

Possible values:

- ▶ Alphanumeric ASCII character string with 0..1024 characters (0x20..0x7E) including space characters
- ▶ <Tab>
- ▶ <Line break>

#### Remaining characters

Displays how many characters are still remaining in the *Banner text* field for the text information.

Possible values:

▶ 1024..0

#### **Buttons**

You find the description of the standard buttons in section “Buttons” on page 14.

### 3.3.5 SNMPv1/v2 Community

[Device Security > Management Access > SNMPv1/v2 Community]

In this dialog you specify the community name for SNMPv1/v2 applications.

Applications send requests via SNMPv1/v2 with a community name in the SNMP data packet header. Depending on the community name, the application gets read authorization or read and write authorization for the device.

You activate the access to the device via SNMPv1/v2 in the [Device Security > Management Access > Server](#) dialog.

#### Table

##### Community

Displays the authorization for SNMPv1/v2 applications to the device:

- ▶ `Write`  
For requests with the community name entered, the application receives read and write authorization for the device.
- ▶ `Read`  
For requests with the community name entered, the application receives read authorization for the device.

##### Name

Specifies the community name for the adjacent authorization.

Possible values:

- ▶ Alphanumeric ASCII character string with 0..32 characters
  - `private` (default setting for read and write authorizations)
  - `public` (default setting for read authorization)

#### Buttons

You find the description of the standard buttons in section [“Buttons” on page 14](#).

## 3.4 Pre-login Banner

[Device Security > Pre-login Banner]

This dialog lets you display a greeting or information text to users before they log in.

The users see this text in the login dialog of the Graphical User Interface and of the Command Line Interface. Users logging in with SSH see the text - regardless of the client used - before or during the login.

To display the text only in the Command Line Interface, use the settings in the [Device Security > Management Access > CLI](#) dialog.

### Operation

Operation

Enables/disables the [Pre-login Banner](#) function.

Using the [Pre-login Banner](#) function, the device displays a greeting or information text in the login dialog of the Graphical User Interface and of the Command Line Interface.

Possible values:

- ▶ [On](#)  
The [Pre-login Banner](#) function is enabled.  
The device displays the text specified in the [Banner text](#) field in the login dialog.
- ▶ [OFF](#) (default setting)  
The [Pre-login Banner](#) function is disabled.  
The device does not display a text in the login dialog. When you enter a text in the [Banner text](#) field, this text is saved in the device.

### Banner text

Banner text

Specifies information text that the device displays in the login dialog of the Graphical User Interface and of the Command Line Interface.

Possible values:

- ▶ Alphanumeric ASCII character string with 0..512 characters  
([0x20..0x7E](#)) including space characters
- ▶ [<Tab>](#)
- ▶ [<Line break>](#)

#### Remaining characters

Displays how many characters are still remaining in the *Banner text* field.

Possible values:

▶ 512..0

#### **Buttons**

You find the description of the standard buttons in section “Buttons” on page 14.





## 4 Network Security

The menu contains the following dialogs:

- ▶ [Network Security Overview](#)
- ▶ [Port Security](#)
- ▶ [802.1X Port Authentication](#)
- ▶ [RADIUS](#)
- ▶ [DoS](#)
- ▶ [ACL](#)

### 4.1 Network Security Overview

[Network Security > Overview]

This dialog displays the network security rules used in the device.

#### Parameter

Port/VLAN

Specifies if the device displays VLAN- and/or port-based rules.

Possible values:

- ▶ [All](#) (default setting)  
The device displays the VLAN- and port-based rules specified by you.
- ▶ [Port: <Port Number>](#)  
The device displays port-based rules for a specific port. This selection is available, when you specified one or more rules for this port.
- ▶ [VLAN: <VLAN ID>](#)  
The device displays VLAN-based rules for a specific VLAN. This selection is available, when you specified one or more rules for this VLAN.

ACL

Displays the [ACL](#) rules in the overview.

You edit [ACL](#) rules in the [Network Security > ACL](#) dialog.

All

Marks the adjacent checkboxes. The device displays the related rules in the overview.

None

Unmarks the adjacent checkboxes. The device does not display any rules in the overview.

## **Buttons**

You find the description of the standard buttons in section [“Buttons” on page 14](#).

## 4.2 Port Security

[Network Security > Port Security]

The device lets you transmit only data packets from desired senders on one port. When this function is enabled, the device checks the VLAN ID and MAC address of the sender before it transmits a data packet. The device discards data packets from other senders and logs this event.

If the *Auto-Disable* function is activated, the device disables the port. This restriction makes MAC Spoofing attacks more difficult. The *Auto-Disable* function enables the relevant port again automatically when the parameters are no longer being exceeded.

In this dialog a *Wizard* window helps you to connect the ports with one or more desired sources. In the device these addresses are known as *Static entries (/)*. To view the specified static addresses, highlight the relevant port and click the  button.

To simplify the setup process, the device lets you record the desired senders automatically. The device “learns” the senders by evaluating the received data packets. In the device these addresses are known as *Dynamic entries*. When a user-defined upper limit has been reached (*Dynamic limit*), the device stops the “learning” on the relevant port and transmits only the data packets of the senders already recorded. When you adjust the upper limit to the number of expected senders, you thus make MAC Flooding attacks more difficult.

**Note:** With the automatic recording of the *Dynamic entries*, the device constantly discards the 1st data packet from unknown senders. Using this 1st data packet, the device checks if the upper limit has been reached. The device records the sender until the upper limit is reached. Afterwards, the device transmits data packets that it receives on the relevant port from this sender.

### Operation

#### Operation

Enables/disables the *Port Security* function.

Possible values:

- ▶ *On*  
 The *Port Security* function is enabled.  
 The device checks the VLAN ID and MAC address of the source before it transmits a data packet.  
 The device transmits a received data packet only if its source is desired on the relevant port. For this setting to take effect, you also activate the checking of the source on the relevant ports.
- ▶ *Off* (default setting)  
 The *Port Security* function is disabled.  
 The device transmits every received data packet without checking the source.

## Configuration

### Auto-disable

Activates/deactivates the *Auto-Disable* function for *Port Security*.

Possible values:

- ▶ *marked*  
The *Auto-Disable* function for *Port Security* is active.  
Also mark the checkbox in the *Auto-disable* column for the relevant ports.
- ▶ *unmarked* (default setting)  
The *Auto-Disable* function for *Port Security* is inactive.

## Table

### Port

Displays the port number.

### Active

Activates/deactivates the checking of the source on the port.

Possible values:

- ▶ *marked*  
The device checks every data packet received on the port and transmits it only if the source of the data packet is allowed. Also enable the function in the *Operation* frame.
- ▶ *unmarked* (default setting)  
The device transmits every data packet received on the port without checking the source.

**Note:** When you operate the device as an active subscriber within an MRP ring, we recommend that you unmark the checkbox.

### Auto-disable

Activates/deactivates the *Auto-Disable* function for the parameters that the *Port Security* function is monitoring on the port.

Possible values:

- ▶ *marked* (default setting)  
The *Auto-Disable* function is active on the port.  
The prerequisite is that you mark the checkbox *Auto-disable* in the *Configuration* frame.
  - If the port registers source MAC addresses that are not allowed or more source MAC addresses than specified in the *Dynamic limit* column, then the device disables the port. The “Link status” LED for the port flashes 3× per period.
  - The *Diagnostics > Ports > Auto-Disable* dialog displays which ports are currently disabled due to the parameters being exceeded.
  - The *Auto-Disable* function reactivates the port automatically. For this you go to the *Diagnostics > Ports > Auto-Disable* dialog and specify a waiting period for the relevant port in the *Reset timer [s]* column.
- ▶ *unmarked*  
The *Auto-Disable* function on the port is inactive.

### Send trap

Activates/deactivates the sending of SNMP traps when the device discards data packets from an undesired sender on the port.

Possible values:

- ▶ `marked`  
If the device discards data packets from a sender that is not allowed on the port, then the device sends an SNMP trap.
- ▶ `unmarked` (default setting)  
The sending of SNMP traps is deactivated.

The prerequisite for sending SNMP traps is that you enable the function in the [Diagnostics > Status Configuration > Alarms \(Traps\)](#) dialog and specify at least one trap destination.

### Trap interval [s]

Specifies the delay time in seconds that the device waits after sending an SNMP trap before sending the next SNMP trap.

Possible values:

- ▶ `0..3600` (default setting: 0)

The value 0 deactivates the delay time.

### Dynamic limit

Specifies the upper limit for the number of automatically registered sources ([Dynamic entries](#)). When the upper limit is reached, the device stops “learning” on this port.

Adjust the value to the number of expected sources.

If the port registers more senders than specified here, then the port disables the [Auto-Disable](#) function. The prerequisite is that you mark the checkbox in the [Auto-disable](#) column and the [Auto-disable](#) checkbox in the [Configuration](#) frame.

Possible values:

- ▶ 0  
Deactivates the automatic registering of sources on this port.
- ▶ `1..600` (default setting: 600)

### Static limit

Specifies the upper limit for the number of sources connected to the port ([Static entries \(/\)](#)). The [Wizard](#) window, [MAC Addresses](#) dialog, helps you to connect the port with one or more desired sources.

Possible values:

- ▶ `0..64` (default setting: 64)

The value 0 helps prevent you from connecting a source with the port.

### Dynamic entries

Displays the number of senders that the device has automatically determined.

See the [Wizard](#) window, [MAC Addresses](#) dialog, [Dynamic entries](#) field.

#### Static MAC entries

Displays the number of senders that are linked with the port.

See the [Wizard](#) window, [MAC Addresses](#) dialog, [Static entries \(/\)](#) field.

#### Last violating VLAN ID/MAC

Displays the VLAN ID and MAC address of an undesired sender whose data packets the device last discarded on this port.

#### Sent traps

Displays the number of discarded data packets on this port that caused the device to send an SNMP trap.

### Buttons

You find the description of the standard buttons in section “Buttons” on page 14.

## [Port security (Wizard)]

The [Wizard](#) window helps you to connect the ports with one or more desired sources. After you specify the settings, click the [Finish](#) button.

**Note:** The device saves the sources connected with the port until you deactivate the checking of the source on the relevant port or in the [Operation](#) frame.

After closing the [Wizard](#) window, click the  button to save your settings.

## [Port security (Wizard) – Select port]

#### Port

Specifies the port that you assign to the sender in the next step.

## [Port security (Wizard) – MAC Addresses]

#### VLAN ID

Specifies the VLAN ID of the desired source.

Possible values:

▶ 1..4042

To transfer the VLAN ID and the MAC address to the [Static entries \(/\)](#) field, click the [Add](#) button.

#### MAC address

Specifies the MAC address of the desired source.

Possible values:

- ▶ Valid Unicast MAC address  
Specify the value with a colon separator, for example `00:11:22:33:44:55`.

To transfer the VLAN ID and the MAC address to the *Static entries (/)* field, click the *Add* button.

#### Add

Transfers the values specified in the *VLAN ID* and *MAC address* fields to the *Static entries (/)* field.

#### Static entries (/)

Displays the VLAN ID and MAC address of desired senders connected to the port.

The device uses this field to display the number of senders connected to the port and the upper limit. You specify the upper limit for the number of entries in the table, *Static limit* field.

**Note:** You cannot assign a MAC address that you assign to this port to any other port.

#### Remove

Removes the entries highlighted in the *Static entries (/)* field.



Moves the entries highlighted in the *Dynamic entries* field to the *Static entries (/)* field.





Moves every entry from the *Dynamic entries* field to the *Static entries (/)* field.

When the *Dynamic entries* field contains more entries than are allowed in the *Static entries (/)* field, the device moves the foremost entries until the upper limit is reached.

#### Dynamic entries

Displays in ascending order the VLAN ID and MAC address of the senders automatically recorded on this port. The device transmits data packets from these senders when receiving the data packets on this port.

You specify the upper limit for the number of entries in the table, *Dynamic limit* field.

The  and  buttons allow you to transfer entries from this field into the *Static entries (/)* field. In this way, you connect the relevant senders with the port.



## 4.3 802.1X Port Authentication

[Network Security > 802.1X Port Authentication]

With the port-based access control according to IEEE 802.1X, the device monitors the access to the network from connected end devices. The device (authenticator) lets an end device (supplicant) have access to the network if it logs in with valid login data. The authenticator and the end devices communicate via the EAPoL (Extensible Authentication Protocol over LANs) authentication protocol.

The device supports the following methods to authenticate end devices:

- ▶ [radius](#)  
A RADIUS server in the network authenticates the end devices.
- ▶ [ias](#)  
The Integrated Authentication Server (IAS) implemented in the device authenticates the end devices. Compared to RADIUS, the IAS provides only basic functions.

The menu contains the following dialogs:

- ▶ [802.1X Global](#)
- ▶ [802.1X Port Configuration](#)
- ▶ [802.1X Port Clients](#)
- ▶ [802.1X EAPoL Port Statistics](#)
- ▶ [802.1X Port Authentication History](#)
- ▶ [802.1X Integrated Authentication Server](#)

## 4.3.1 802.1X Global

[Network Security > 802.1X Port Authentication > Global]

This dialog lets you specify basic settings for the port-based access control.

### Operation

#### Operation

Enables/disables the *802.1X Port Authentication* function.

Possible values:

- ▶ *On*  
The *802.1X Port Authentication* function is enabled.  
The device checks the access to the network from connected end devices.  
The port-based access control is enabled.
- ▶ *Off* (default setting)  
The *802.1X Port Authentication* function is disabled.  
The port-based access control is disabled.

### Configuration

#### VLAN assignment

Activates/deactivates the assigning of the relevant port to a VLAN. This function lets you provide selected services to the connected end device in this VLAN.

Possible values:

- ▶ *marked*  
The assigning is active.  
If the end device successfully authenticates itself, then the device assigns to the relevant port the VLAN ID transferred by the RADIUS authentication server.
- ▶ *unmarked* (default setting)  
The assigning is inactive.  
The relevant port is assigned to the VLAN specified in the *Network Security > 802.1X Port Authentication > Port Configuration* dialog, *Assigned VLAN ID* row.

#### Dynamic VLAN creation

Activates/deactivates the automatic creation of the VLAN assigned by the RADIUS authentication server if the VLAN does not exist.

Possible values:

- ▶ *marked*  
The automatic VLAN creation is active.  
The device creates the VLAN if it does not exist.
- ▶ *unmarked* (default setting)  
The automatic VLAN creation is inactive.  
If the assigned VLAN does not exist, then the port remains assigned to the original VLAN.

### Monitor mode

Activates/deactivates the monitor mode.

Possible values:

▶ `marked`

The monitor mode is active.

The device monitors the authentication and helps with diagnosing detected errors. If an end device has not logged in successfully, then the device gives the end device access to the network.

▶ `unmarked` (default setting)

The monitor mode is inactive.

### Information

#### Monitor mode clients

Displays to how many end devices the device gave network access even though they did not log in successfully.

The prerequisite is that you activate the *Monitor mode* function. See the *Configuration* frame.

#### Non monitor mode clients

Displays the number of end devices to which the device gave network access after successful login.

#### Policy 1

Displays the method that the device currently uses to authenticate the end devices using IEEE 802.1X.

You specify the method used in the *Device Security > Authentication List* dialog.

- To authenticate the end devices through a RADIUS server, you assign the `radius` policy to the `8021x` list.
- To authenticate the end devices through the Integrated Authentication Server (IAS) you assign the `ias` policy to the `8021x` list.

### Buttons

You find the description of the standard buttons in section “Buttons” on page 14.

## 4.3.2 802.1X Port Configuration

[Network Security > 802.1X Port Authentication > Port Configuration]

This dialog lets you specify the access settings for every port.

### Table

Port

Displays the port number.

Port initialization

Activates/deactivates the port initialization in order to activate the access control on the port or reset it to its initial state. Use this function only on ports in which the *Port control* column contains the value *auto*.

Possible values:

- ▶ *marked*  
The port initialization is active.  
When the initialization is complete, the device changes the value to *unmarked* again.
- ▶ *unmarked* (default setting)  
The port initialization is inactive.  
The device keeps the current port status.

Port reauthentication

Activates/deactivates the one-time reauthentication request.

Use this function only on ports in which the *Port control* column contains the value *auto*.

The device also lets you periodically request the end device to log in again. See the *Periodic reauthentication* column.

Possible values:

- ▶ *marked*  
The one-time reauthentication request is active.  
The device requests the end device to log in again. Afterwards, the device changes the value to *unmarked* again.
- ▶ *unmarked* (default setting)  
The one-time reauthentication request is inactive.  
The device keeps the end device logged in.

Authentication activity

Displays the current status of the Authenticator (*Authenticator PAE state*).

Possible values:

- ▶ *initialize*
- ▶ *disconnected*
- ▶ *connecting*
- ▶ *authenticating*

- ▶ *authenticated*
- ▶ *aborting*
- ▶ *held*
- ▶ *forceAuth*
- ▶ *forceUnauth*

### Backend authentication state

Displays the current status of the connection to the authentication server ([Backend Authentication state](#)).

#### Possible values:

- ▶ *request*
- ▶ *response*
- ▶ *success*
- ▶ *fail*
- ▶ *timeout*
- ▶ *idle*
- ▶ *initialize*

### Authentication state

Displays the current status of the authentication on the port ([Controlled Port Status](#)).

#### Possible values:

- ▶ *authorized*  
The end device is logged in successfully.
- ▶ *unauthorized*  
The end device is not logged in.

### Port control

Specifies how the device grants access to the network ([Port control mode](#)).

#### Possible values:

- ▶ *forceUnauthorized*  
The device blocks the access to the network. You use this setting if an end device is connected to the port that does not receive access to the network.
- ▶ *auto*  
The device grants access to the network if the end device logged in successfully. You use this setting if an end device is connected to the port that logs in at the authenticator.

**Note:** If other end devices are connected through the same port, then they get access to the network without additional authentication.

- ▶ *forceAuthorized* (default setting)  
When end devices do not support IEEE 802.1X, the device grants access to the network. You use this setting if an end device is connected to the port that receives access to the network without logging in.

## Quiet period [s]

Specifies the time period in seconds in which the authenticator does not accept any more logins from the end device after an unsuccessful login attempt (*Quiet period [s]*).

Possible values:

▶ 0..65535 (default setting: 60)

## Transmit period [s]

Specifies the period in seconds after which the authenticator requests the end device to log in again. After this waiting period, the device sends an EAP request/identity data packet to the end device.

Possible values:

▶ 1..65535 (default setting: 30)

## Supplicant timeout period [s]

Specifies the period in seconds for which the authenticator waits for the login of the end device.

Possible values:

▶ 1..65535 (default setting: 30)

## Server timeout [s]

Specifies the period in seconds for which the authenticator waits for the response from the authentication server (RADIUS or IAS).

Possible values:

▶ 1..65535 (default setting: 30)

## Requests (max.)

Specifies how many times the authenticator requests the end device to log in until the time specified in the *Supplicant timeout period [s]* column has elapsed. The device sends an EAP request/identity data packet to the end device as often as specified here.

Possible values:

▶ 0..10 (default setting: 2)

## Assigned VLAN ID

Displays the ID of the VLAN that the authenticator assigned to the port. This value applies only on ports in which the *Port control* column contains the value *auto*.

Possible values:

▶ 0..4042 (default setting: 0)

You find the VLAN ID that the authenticator assigned to the ports in the *Network Security > 802.1X Port Authentication > Port Clients* dialog.

### Assignment reason

Displays the cause for the assignment of the VLAN ID. This value applies only on ports in which the *Port control* column contains the value *auto*.

Possible values:

- ▶ *notAssigned* (default setting)
- ▶ *radius*
- ▶ *guestVlan*
- ▶ *unauthenticatedVlan*

You find the VLAN ID that the authenticator assigned to the ports for a supplicant in the *Network Security > 802.1X Port Authentication > Port Clients* dialog.

### Reauthentication period [s]

Specifies the period in seconds after which the authenticator periodically requests the end device to log in again.

Possible values:

- ▶ *1..65535* (default setting: *3600*)

### Periodic reauthentication

Activates/deactivates periodic reauthentication requests.

Possible values:

- ▶ *marked*  
The periodic reauthentication requests are active.  
The device periodically requests the end device to log in again. You specify this time period in the *Reauthentication period [s]* column.  
If the authenticator assigned the ID of a Voice VLAN, Unauthenticated VLAN or Guest VLAN to the end device, then this setting becomes ineffective.
- ▶ *unmarked* (default setting)  
The periodic reauthentication requests are inactive.  
The device keeps the end device logged in.

### Guest VLAN ID

Specifies the ID of the VLAN that the authenticator assigns to the port if the end device does not log in during the time period specified in the *Guest VLAN period* column. This value applies only on ports in which the *Port control* column contains the value *auto*.

This function lets you grant end devices, without IEEE 802.1X support, access to selected services in the network.

Possible values:

- ▶ *0* (default setting)  
The authenticator does not assign a Guest VLAN to the port.
- ▶ *1..4042*

**Note:** The *MAC authorized bypass* function and the *Guest VLAN ID* function cannot be in use simultaneously.

### Guest VLAN period

Specifies the period in seconds for which the authenticator waits for EAPOL data packets after the end device is connected. If this period elapses, then the authenticator grants the end device access to the network and assigns the port to the Guest VLAN specified in the *Guest VLAN ID* column.

Possible values:

▶ 1..300 (default setting: 90)

### Unauthenticated VLAN ID

Specifies the ID of the VLAN that the authenticator assigns to the port if the end device does not log in successfully. This value applies only on ports in which the *Port control* column contains the value *auto*.

This function lets you grant end devices without valid login data access to selected services in the network.

Possible values:

▶ 0..4042 (default setting: 0)

The effect of the value 0 is that the authenticator does not assign a Unauthenticated VLAN to the port.

**Note:** Assign to the port a VLAN set up statically in the device.

## Buttons

You find the description of the standard buttons in section [“Buttons” on page 14](#).



### 4.3.3 802.1X Port Clients

[Network Security > 802.1X Port Authentication > Port Clients]

This dialog displays information on the connected end devices.

#### Table

Port

Displays the port number.

User name

Displays the user name with which the end device logged in.

MAC address

Displays the MAC address of the end device.

Assigned VLAN ID

Displays the VLAN ID that the authenticator assigned to the port after the successful authentication of the end device.

Assignment reason

Displays the reason for the assignment of the VLAN.

Possible values:

- ▶ *default*
- ▶ *radius*
- ▶ *unauthenticatedVlan*
- ▶ *guestVlan*
- ▶ *monitorVlan*
- ▶ *invalid*

The field only displays a valid value as long as the client is authenticated.

Session timeout

Displays the remaining time in seconds until the login of the end device expires. This value applies only if for the port in the [Network Security > 802.1X Port Authentication > Port Configuration](#) dialog, [Port control](#) column the value *auto* is specified.

The authentication server assigns the timeout period to the device through RADIUS. The value 0 means that the authentication server has not assigned a timeout.

#### Termination action

Displays the action performed by the device when the login has elapsed.

Possible values:

- ▶ *default*
- ▶ *reauthenticate*

#### **Buttons**

You find the description of the standard buttons in section [“Buttons” on page 14](#).

### 4.3.4 802.1X EAPOL Port Statistics

[Network Security > 802.1X Port Authentication > Statistics]

This dialog displays which EAPOL data packets the end device has sent and received for the authentication of the end devices.

#### Table

Port

Displays the port number.

Received packets

Displays the total number of EAPOL data packets that the device received on the port.

Transmitted packets

Displays the total number of EAPOL data packets that the device sent on the port.

Start packets

Displays the number of EAPOL start data packets that the device received on the port.

Logoff packets

Displays the number of EAPOL logoff data packets that the device received on the port.

Response/ID packets

Displays the number of EAP response/identity data packets that the device received on the port.

Response packets

Displays the number of valid EAP response data packets that the device received on the port (without EAP response/identity data packets).

Request/ID packets

Displays the number of EAP request/identity data packets that the device received on the port.

Request packets

Displays the number of valid EAP request data packets that the device received on the port (without EAP request/identity data packets).

Invalid packets

Displays the number of EAPOL data packets with an unknown frame type that the device received on the port.

#### Received error packets

Displays the number of EAPOL data packets with an invalid packet body length field that the device received on the port.

#### Packet version

Displays the protocol version number of the EAPOL data packet that the device last received on the port.

#### Source of last received packet

Displays the sender MAC address of the EAPOL data packet that the device last received on the port.

The value `00:00:00:00:00:00` means that the port has not received any EAPOL data packets yet.

### **Buttons**

You find the description of the standard buttons in section [“Buttons” on page 14](#).

## 4.3.5 802.1X Port Authentication History

[Network Security > 802.1X Port Authentication > Port Authentication History]

The device registers the authentication process of the end devices that are connected to its ports. This dialog displays the information recorded during the authentication.

### Table

Port

Displays the port number.

Authentication time stamp

Displays the time at which the authenticator authenticated the end device.

Result age

Displays since when this entry has been entered in the table.

MAC address

Displays the MAC address of the end device.

VLAN ID

Displays the ID of the VLAN that was assigned to the end device before the login.

Authentication status

Displays the status of the authentication on the port.

Possible values:

- ▶ *success*  
The authentication was successful.
- ▶ *failure*  
The authentication failed.

Access status

Displays if the device grants the end device access to the network.

Possible values:

- ▶ *granted*  
The device grants the end device access to the network.
- ▶ *denied*  
The device denies the end device access to the network.

Assigned VLAN ID

Displays the ID of the VLAN that the authenticator assigned to the port.

#### Assignment type

Displays the type of the VLAN that the authenticator assigned to the port.

Possible values:

- ▶ `default`
- ▶ `radius`
- ▶ `unauthenticatedVlan`
- ▶ `guestVlan`
- ▶ `monitorVlan`
- ▶ `notAssigned`

#### Assignment reason

Displays the reason for the assignment of the VLAN ID and the VLAN type.

### 802.1X Port Authentication History

#### Port

Simplifies the table and displays only the entries relating to the port selected here. This makes it easier for you to record the table and sort it as you desire.

Possible values:

- ▶ `all`  
The table displays the entries for every port.
- ▶ `<Port number>`  
The table displays the entries that apply to the port selected here.

### Buttons

You find the description of the standard buttons in section [“Buttons” on page 14](#).

## 4.3.6 802.1X Integrated Authentication Server

[Network Security > 802.1X Port Authentication > Integrated Authentication Server]

The Integrated Authentication Server (IAS) lets you authenticate end devices using IEEE 802.1X. Compared to RADIUS, the IAS has a very limited range of functions. The authentication is based only on the user name and the password.

In this dialog you manage the login data of the end devices. The device lets you set up to 100 sets of login data.

To authenticate the end devices through the Integrated Authentication Server you assign in the [Device Security > Authentication List](#) dialog the `ias` policy to the 8021x list.

### Table

#### User name

Displays the user name of the end device.

To create a new user, click the  button.

#### Password

Specifies the password with which the user authenticates.

Possible values:

- ▶ Alphanumeric ASCII character string with 0..64 characters

The device differentiates between upper and lower case.

#### Active

Activates/deactivates the login data.

Possible values:

- ▶ `marked`  
The login data is active. An end device has the option of logging in through IEEE 802.1X using this login data.
- ▶ `unmarked` (default setting)  
The login data is inactive.

### Buttons

You find the description of the standard buttons in section [“Buttons” on page 14](#).

## 4.4 RADIUS

[Network Security > RADIUS]

With its factory settings, the device authenticates users based on the local user management. However, as the size of a network increases, it becomes more difficult to keep the login data of the users consistent across the devices.

RADIUS (Remote Authentication Dial-In User Service) lets you authenticate and authorize the users at a central point in the network. A RADIUS server performs the following tasks here:

- ▶ Authentication  
The authentication server authenticates the users when the RADIUS client at the access point forwards the login data of the users to the server.
- ▶ Authorization  
The authentication server authorizes logged in users for selected services by assigning various parameters for the relevant end device to the RADIUS client at the access point.
- ▶ Accounting  
The accounting server records the traffic data that has occurred during the port authentication according to IEEE 802.1X. This enables you to subsequently determine which services the users have used, and to what extent.

If you assign the `radius` policy to an application in the *Device Security > Authentication List* dialog, then the device operates in the role of the RADIUS client. The device forwards the users' login data to the primary authentication server. The authentication server decides if the login data is valid and transfers the user's authorizations to the device.

The device assigns the Service Type transferred in the response of a RADIUS server as follows to a user role existing in the device:

- `Administrative-User: administrator`
- `Login-User: operator`
- `NAS-Prompt-User: guest`

The device also lets you authenticate end devices with IEEE 802.1X through an authentication server. To do this, you assign the `radius` policy to the `8021x` list in the *Device Security > Authentication List* dialog.

The menu contains the following dialogs:

- ▶ [RADIUS Global](#)
- ▶ [RADIUS Authentication Server](#)
- ▶ [RADIUS Accounting Server](#)
- ▶ [RADIUS Authentication Statistics](#)
- ▶ [RADIUS Accounting Statistics](#)



## 4.4.1 RADIUS Global

[Network Security > RADIUS > Global]

This dialog lets you specify basic settings for RADIUS.

### RADIUS configuration

#### Retransmits (max.)

Specifies how many times the device retransmits an unanswered request to the authentication server before the device sends the request to an alternative authentication server.

Possible values:

- ▶ 1..15 (default setting: 4)

#### Timeout [s]

Specifies how many seconds the device waits for a response after a request to an authentication server before it retransmits the request.

Possible values:

- ▶ 1..30 (default setting: 5)

#### Accounting

Activates/deactivates the accounting.

Possible values:

- ▶ `marked`  
Accounting is active.  
The device sends the traffic data to an accounting server specified in the [Network Security > RADIUS > Accounting Server](#) dialog.
- ▶ `unmarked` (default setting)  
Accounting is inactive.

#### NAS IP address (attribute 4)

Specifies the IP address that the device transfers to the authentication server as attribute 4. Specify the IP address of the device or another available address.

Possible values:

- ▶ Valid IPv4 address (default setting: 0.0.0.0)

In many cases, there is a firewall between the device and the authentication server. In the Network Address Translation (NAT) in the firewall changes the original IP address, and the authentication server receives the translated IP address of the device.

The device transfers the IP address in this field unchanged across the Network Address Translation (NAT).

## Buttons

You find the description of the standard buttons in section [“Buttons” on page 14](#).

### Reset

Deletes the statistics in the [Network Security > RADIUS > Authentication Statistics](#) dialog and in the [Network Security > RADIUS > Accounting Statistics](#) dialog.

## 4.4.2 RADIUS Authentication Server

[Network Security > RADIUS > Authentication Server]

This dialog lets you specify up to 8 authentication servers. An authentication server authenticates and authorizes the users when the device forwards the login data to the server.

The device sends the login data to the specified primary authentication server. When the server does not respond, the device contacts the specified authentication server that is highest in the table. When no response comes from this server either, the device contacts the next server in the table.

### Table

Index

Displays the index number to which the table entry relates.

Name

Displays the name of the server.

To change the value, click the relevant field.

Possible values:

- ▶ Alphanumeric ASCII character string with 1..32 characters (default setting: [Default-RADIUS-Server](#))

Address

Specifies the IP address of the server.

Possible values:

- ▶ Valid IPv4 address

Destination UDP port

Specifies the number of the UDP port on which the server receives requests.

Possible values:

- ▶ [0..65535](#) (default setting: [1812](#))  
Exception: Port [2222](#) is reserved for internal functions.

Secret

Displays **\*\*\*\*\*** (asterisks) when you specify a password with which the device logs in to the server. To change the password, click the relevant field.

Possible values:

- ▶ Alphanumeric ASCII character string with 1..64 characters

You get the password from the administrator of the authentication server.

### Primary server

Specifies the authentication server as primary or secondary.

Possible values:

- ▶ [marked](#)  
The server is specified as the primary authentication server. The device sends the login data for authenticating the users to this authentication server.  
When you activate multiple servers, the device specifies the last server activated as the primary authentication server.
- ▶ [unmarked](#) (default setting)  
The server is the secondary authentication server. When the device does not receive a response from the primary authentication server, the device sends the login data to the secondary authentication server.

### Active

Activates/deactivates the connection to the server.

The device uses the server, if you specify in the [Device Security > Authentication List](#) dialog the value [radius](#) in one of the rows [Policy 1](#) to [Policy 5](#).

Possible values:

- ▶ [marked](#) (default setting)  
The connection is active. The device sends the login data for authenticating the users to this server if the preconditions named above are fulfilled.
- ▶ [unmarked](#)  
The connection is inactive. The device does not send any login data to this server.

## Buttons

You find the description of the standard buttons in section [“Buttons” on page 14](#).



Opens the [Create](#) window to add a new entry to the table.

- ▶ In the [Index](#) field, you specify the index number.
- ▶ In the [Address](#) field, you specify the IP address of the server.

### 4.4.3 RADIUS Accounting Server

[Network Security > RADIUS > Accounting Server]

This dialog lets you specify up to 8 accounting servers. An accounting server records the traffic data that has occurred during the port authentication according to IEEE 802.1X. The prerequisite is that you activate in the *Network Security > RADIUS > Global* menu the *Accounting* function.

The device sends the traffic data to the first accounting server that can be reached. When the accounting server does not respond, the device contacts the next server in the table.

#### Table

##### Index

Displays the index number to which the table entry relates.

Possible values:

▶ 1..8

##### Name

Displays the name of the server.

To change the value, click the relevant field.

Possible values:

▶ Alphanumeric ASCII character string with 1..32 characters  
(default setting: *Default-RADIUS-Server*)

##### Address

Specifies the IP address of the server.

Possible values:

▶ Valid IPv4 address

##### Destination UDP port

Specifies the number of the UDP port on which the server receives requests.

Possible values:

▶ 0..65535 (default setting: 1813)  
Exception: Port 2222 is reserved for internal functions.

##### Secret

Displays \*\*\*\*\* (asterisks) when you specify a password with which the device logs in to the server. To change the password, click the relevant field.

Possible values:

▶ Alphanumeric ASCII character string with 1..16 characters

You get the password from the administrator of the authentication server.

## Active

Activates/deactivates the connection to the server.

Possible values:

- ▶ [marked](#) (default setting)  
The connection is active. The device sends traffic data to this server if the preconditions named above are fulfilled.
- ▶ [unmarked](#)  
The connection is inactive. The device does not send any traffic data to this server.

## Buttons

You find the description of the standard buttons in section [“Buttons” on page 14](#).



Opens the [Create](#) window to add a new entry to the table.

- ▶ In the [Index](#) field, you specify the index number.
- ▶ In the [Address](#) field, you specify the IP address of the server.

## 4.4.4 RADIUS Authentication Statistics

[Network Security > RADIUS > Authentication Statistics]

This dialog displays information about the communication between the device and the authentication server. The table displays the information for each server in a separate row.

To delete the statistic, click in the *Network Security > RADIUS > Global* dialog the *Clear RADIUS statistics?* button.

### Table

Name

Displays the name of the server.

Address

Displays the IP address of the server.

Round trip time

Displays the time interval in hundredths of a second between the last response received from the server (Access Reply/Access Challenge) and the corresponding data packet sent (Access Request).

Access requests

Displays the number of access data packets that the device sent to the server. This value does not take repetitions into account.

Retransmitted access-request packets

Displays the number of access data packets that the device retransmitted to the server.

Access accepts

Displays the number of access accept data packets that the device received from the server.

Access rejects

Displays the number of access reject data packets that the device received from the server.

Access challenges

Displays the number of access challenge data packets that the device received from the server.

Malformed access responses

Displays the number of malformed access response data packets that the device received from the server (including data packets with an invalid length).

#### Bad authenticators

Displays the number of access response data packets with an invalid authenticator that the device received from the server.

#### Pending requests

Displays the number of access request data packets that the device sent to the server to which it has not yet received a response from the server.

#### Timeouts

Displays how many times no response to the server was received before the specified waiting time elapsed.

#### Unknown types

Displays the number data packets with an unknown data type that the device received from the server on the authentication port.

#### Packets dropped

Displays the number of data packets that the device received from the server on the authentication port and then discarded them.

### **Buttons**

You find the description of the standard buttons in section [“Buttons” on page 14](#).



## 4.4.5 RADIUS Accounting Statistics

[Network Security > RADIUS > Accounting Statistics]

This dialog displays information about the communication between the device and the accounting server. The table displays the information for each server in a separate row.

To delete the statistic, click in the *Network Security > RADIUS > Global* dialog the *Clear RADIUS statistics?* button.

### Table

Name

Displays the name of the server.

Address

Displays the IP address of the server.

Round trip time

Displays the time interval in hundredths of a second between the last response received from the server (Accounting Response) and the corresponding data packet sent (Accounting Request).

Accounting-request packets

Displays the number of accounting request data packets that the device sent to the server. This value does not take repetitions into account.

Retransmitted accounting-request packets

Displays the number of accounting request data packets that the device retransmitted to the server.

Received packets

Displays the number of accounting response data packets that the device received from the server.

Malformed packets

Displays the number of malformed accounting response data packets that the device received from the server (including data packets with an invalid length).

Bad authenticators

Displays the number of accounting response data packets with an invalid authenticator that the device received from the server.

Pending requests

Displays the number of accounting request data packets that the device sent to the server to which it has not yet received a response from the server.

#### Timeouts

Displays how many times no response to the server was received before the specified waiting time elapsed.

#### Unknown types

Displays the number data packets with an unknown data type that the device received from the server on the accounting port.

#### Packets dropped

Displays the number of data packets that the device received from the server on the accounting port and then discarded them.

### Buttons

You find the description of the standard buttons in section [“Buttons” on page 14](#).

## 4.5 DoS

[Network Security > DoS]

Denial of Service (DoS) is a cyber-attack that aims to bring down specific services or devices. In this dialog you can set up several filters to help protect the device itself and other devices in the network from DoS attacks.

The menu contains the following dialogs:

▶ [DoS Global](#)

## 4.5.1 DoS Global

[Network Security > DoS > Global]

In this dialog you specify the DoS settings for the TCP/UDP, IP and ICMP protocols.

### TCP/UDP

A scanner uses port scans to prepare network attacks. The scanner uses different techniques to determine running devices and open ports. This frame lets you activate filters for specific scanning techniques.

The device supports the detection of the following scan types:

- ▶ Null scans
- ▶ Xmas scans
- ▶ SYN/FIN scans
- ▶ TCP Offset attacks
- ▶ TCP SYN attacks
- ▶ L4 Port attacks
- ▶ Minimal Header scans

#### Null Scan filter

Activates/deactivates the Null Scan filter.

The Null Scan filter detects incoming data packets with no TCP flags set and discards them.

Possible values:

- ▶ `marked`  
The filter is active.
- ▶ `unmarked` (default setting)  
The filter is inactive.

#### Xmas filter

Activates/deactivates the Xmas filter.

The Xmas filter detects incoming data packets with the TCP flags FIN, URG and PUSH set simultaneously and discards them.

Possible values:

- ▶ `marked`  
The filter is active.
- ▶ `unmarked` (default setting)  
The filter is inactive.

#### SYN/FIN filter

Activates/deactivates the SYN/FIN filter.

The SYN/FIN filter detects incoming data packets with the TCP flags SYN and FIN set simultaneously and discards them.

Possible values:

- ▶ `marked`  
The filter is active.
- ▶ `unmarked` (default setting)  
The filter is inactive.

#### TCP Offset protection

Activates/deactivates the TCP Offset protection.

The TCP Offset protection detects incoming TCP data packets whose fragment offset field of the IP header is equal to 1 and discards them.

The TCP Offset protection accepts UDP and ICMP packets whose fragment offset field of the IP header is equal to 1.

Possible values:

- ▶ `marked`  
The protection is active.
- ▶ `unmarked` (default setting)  
The protection is inactive.

#### TCP SYN protection

Activates/deactivates the TCP SYN protection.

The TCP SYN protection detects incoming data packets with the TCP flag SYN set and a L4 source port <1024 and discards them.

Possible values:

- ▶ `marked`  
The protection is active.
- ▶ `unmarked` (default setting)  
The protection is inactive.

#### L4 Port protection

Activates/deactivates the L4 Port protection.

The L4 Port protection detects incoming TCP and UDP data packets whose source port number and destination port number are identical and discards them.

Possible values:

- ▶ `marked`  
The protection is active.
- ▶ `unmarked` (default setting)  
The protection is inactive.

#### Min. Header Size filter

Activates/deactivates the Minimal Header filter.

The Minimal Header filter detects incoming data packets whose IP payload length in the IP header less the outer IP header size is smaller than the minimum TCP header size. If this is the first fragment that the device detects, then the device discards the data packet.

Possible values:

- ▶ `marked`  
The filter is active.
- ▶ `unmarked` (default setting)  
The filter is inactive.

Min. TCP header size

Displays the minimum size of a valid TCP header.

## IP

This frame lets you activate or deactivate the Land Attack filter. With the land attack method, the attacking station sends data packets whose source and destination addresses are identical to those of the recipient. When you activate this filter, the device detects data packets with identical source and destination addresses and discards these data packets.

Land Attack filter

Activates/deactivates the Land Attack filter.

The Land Attack filter detects incoming IP data packets whose source and destination IP address are identical and discards them.

Possible values:

- ▶ `marked`  
The filter is active.
- ▶ `unmarked` (default setting)  
The filter is inactive.

## ICMP

This dialog provides you with filter options for the following ICMP parameters:

- ▶ Fragmented data packets
- ▶ ICMP packets from a specific size upwards
- ▶ Broadcast pings

Filter fragmented packets

Activates/deactivates the filter for fragmented ICMP packets.

The filter detects fragmented ICMP packets and discards them.

Possible values:

- ▶ `marked`  
The filter is active.
- ▶ `unmarked` (default setting)  
The filter is inactive.

#### Filter by packet size

Activates/deactivates the filter for incoming ICMP packets.

The filter detects ICMP packets whose payload size exceeds the size specified in the *Allowed payload size [byte]* field and discards them.

Possible values:

- ▶ *marked*  
The filter is active.
- ▶ *unmarked* (default setting)  
The filter is inactive.

#### Allowed payload size [byte]

Specifies the maximum allowed payload size of ICMP packets in bytes.

Mark the *Filter by packet size* checkbox if you want the device to discard incoming data packets whose payload size exceeds the maximum allowed size for ICMP packets.

Possible values:

- ▶ *0..1472* (default setting: *512*)

#### Drop broadcast ping

Activates/deactivates the filter for Broadcast Pings. Broadcast Pings are a known evidence for Smurf Attacks.

Possible values:

- ▶ *marked*  
The filter is active.  
The device detects Broadcast Pings and drops them.
- ▶ *unmarked* (default setting)  
The filter is inactive.

### Buttons

You find the description of the standard buttons in section “Buttons” on page 14.

## 4.6 ACL

[Network Security > ACL]

In this menu, you specify the settings for the Access Control Lists (ACL). Access Control Lists contain rules which the device applies successively to the data stream on its ports or VLANs.

If a data packet complies with the criteria of one or more rules, then the device applies the action specified in the first rule that applies to the data stream. The device ignores the rules following.

Possible actions include:

- ▶ *permit*: The device transmits the data packet to a port or to a VLAN.
- ▶ *deny*: The device drops the data packet.

In the default setting, the device forwards every data packet. Once you assign an Access Control List to an interface or VLAN, there is changing this behavior. The device enters at the end of an Access Control List an implicit Deny-All rule. Consequently, the device discards data packets that do not meet any of the rules. If you want a different behavior, then add a "permit" rule at the end of your Access Control Lists.

Proceed as follows to set up Access Control Lists and rules:

- Make a rule and specify the rule settings. See the [Network Security > ACL > IPv4 Rule](#) dialog, or the [Network Security > ACL > MAC Rule](#) dialog.
- Assign the Access Control List to the Ports and VLANs of the device. See the [Network Security > ACL > Assignment](#) dialog.

The menu contains the following dialogs:

- ▶ [ACL IPv4 Rule](#)
- ▶ [ACL MAC Rule](#)
- ▶ [ACL Assignment](#)

## 4.6.1 ACL IPv4 Rule

[Network Security > ACL > IPv4 Rule]

In this dialog you specify the rules that the device applies to the IP data packets.

An Access Control List (group) contains one or more rules. The device applies the rules of an Access Control List successively, beginning with the rule with the lowest value in the *Index* column.

The device lets you filter according to the following criteria:

- ▶ Source or destination IP address of a data packet
- ▶ Type of the transmitting protocol
- ▶ Source or destination port of a data packet

### Table

Group name

Displays the name of the Access Control List. The Access Control List contains the rules.

Index

Displays the number of the rule within the Access Control List.

If the Access Control List contains multiple rules, then the device processes the rule with the lowest value first.

Match every packet

Specifies to which IP data packets the device applies the rule.

Possible values:

- ▶ *marked* (default setting)  
The device applies the rule to every IP data packet.
- ▶ *unmarked*  
The device applies the rule to IP data packets depending on the value in the *Source IP address*, *Destination IP address*, and *Protocol* fields.

Source IP address

Specifies the source address of the IP data packets to which the device applies the rule.

Possible values:

- ▶ *?.?.?.?* (default setting)  
The device applies the rule to IP data packets with any source address.



- ▶ Valid IPv4 address  
The device applies the rule to IP data packets with the specified source address. You use the ? character as a wild card.  
Example `192.?.?.32`: The device applies the rule to IP data packets whose source address begins with `192.` and ends with `.32`.
- ▶ Valid IPv4 address/bit mask  
The device applies the rule to IP data packets with the specified source address. The inverse bit mask lets you specify the address range with bit-level accuracy.  
Example `192.168.1.0/0.0.0.127`: The device applies the rule to IP data packets with a source address in the range from `192.168.1.0` to `...127`.

#### Destination IP address

Specifies the destination address of the IP data packets to which the device applies the rule.

Possible values:

- ▶ `?.?.?.?` (default setting)  
The device applies the rule to IP data packets with any destination address.
- ▶ Valid IPv4 address  
The device applies the rule to IP data packets with the specified destination address. You use the ? character as a wild card.  
Example `192.?.?.32`: The device applies the rule to IP data packets whose source address begins with `192.` and ends with `.32`.
- ▶ Valid IPv4 address/bit mask  
The device applies the rule to IP data packets with the specified destination address. The inverse bit mask lets you specify the address range with bit-level accuracy.  
Example `192.168.1.0/0.0.0.127`: The device applies the rule to IP data packets with a destination address in the range from `192.168.1.0` to `...127`.

#### Protocol

Specifies the protocol type of the IP data packets to which the device applies the rule.

Possible values:

- ▶ `any` (default setting)  
The device applies the rule to every IP data packet without considering the protocol type.
- ▶ `icmp`
- ▶ `igmp`
- ▶ `ip-in-ip`
- ▶ `tcp`
- ▶ `udp`
- ▶ `ip`

#### Source TCP/UDP port

Specifies the source port of the IP data packets to which the device applies the rule. The prerequisite is that you specify in the *Protocol* column the value `TCP` or `UDP`.

Possible values:

- ▶ `any` (default setting)  
The device applies the rule to every IP data packet without considering the source port.
- ▶ `1..65535`  
The device applies the rule only to IP data packets containing the specified source port.

#### Destination TCP/UDP port

Specifies the destination port of the IP data packets to which the device applies the rule. The prerequisite is that you specify in the *Protocol* column the value *TCP* or *UDP*.

Possible values:

- ▶ *any* (default setting)  
The device applies the rule to every IP data packet without considering the destination port.
- ▶ *1..65535*  
The device applies the rule only to IP data packets containing the specified destination port.

#### Action

Specifies how the device processes received IP data packets when the device applies the rule.

Possible values:

- ▶ *permit* (default setting)  
The device transmits the IP data packets.
- ▶ *deny*  
The device drops the IP data packets.

#### Log

Activates/deactivates the logging in the log file. See the *Diagnostics > Report > System Log* dialog.

Possible values:

- ▶ *marked*  
Logging is activated.  
The prerequisite is that you assign the Access Control List in the *Network Security > ACL > Assignment* dialog to a VLAN or port.  
The device registers in the log file, in an interval of 30 s, how many times it applied the deny rule to IP data packets.
- ▶ *unmarked* (default setting)  
Logging is deactivated.

The device lets you activate this function for up to 128 deny rules.

### Buttons

You find the description of the standard buttons in section “Buttons” on page 14.



Opens the *Create* window to add a new entry to the table.

- ▶ In the *Group name* field, you specify the name of the Access Control List to which the rule belongs.
- ▶ In the *Index* field, you specify the number of the rule within the Access Control List. If the Access Control List contains multiple rules, then the device processes the rule with the lowest value first.

## 4.6.2 ACL MAC Rule

[Network Security > ACL > MAC Rule]

In this dialog you specify the rules that the device applies to the MAC data packets.

An Access Control List (group) contains one or more rules. The device applies the rules of an Access Control List successively, beginning with the rule with the lowest value in the *Index* column.

The device lets you filter for the source or destination MAC address of a data packet.

### Table

Group name

Displays the name of the Access Control List. The Access Control List contains the rules.

Index

Displays the number of the rule within the Access Control List.

If the Access Control List contains multiple rules, then the device processes the rule with the lowest value first.

Match every packet

Specifies to which MAC data packets the device applies the rule.

Possible values:

- ▶ *marked* (default setting)  
The device applies the rule to every MAC data packet.
- ▶ *unmarked*  
The device applies the rule to MAC data packets depending on the value in the *Source MAC address* and *Destination MAC address* fields.

Source MAC address

Specifies the source address of the MAC data packets to which the device applies the rule.

Possible values:

- ▶ *?:?:?:?:?:?:?:?* (default setting)  
The device applies the rule to MAC data packets with any source address.
- ▶ Valid MAC address  
The device applies the rule to MAC data packets with the specified source address. You use the ? character as a wild card.  
Example *00:11:?:?:?:?:?:?*: The device applies the rule to MAC data packets whose source address begins with *00:11*.
- ▶ Valid MAC address/bit mask  
The device applies the rule to MAC data packets with the specified source address. The bit mask lets you specify the address range with bit-level accuracy.  
Example *00:11:22:33:44:54/FF:FF:FF:FF:FF:FC*: The device applies the rule to MAC data packets with a source address in the range from *00:11:22:33:44:54* to *...:57*.

#### Destination MAC address

Specifies the destination address of the MAC data packets to which the device applies the rule.

Possible values:

- ▶ `?:?:?:?:?:?:?:?` (default setting)  
The device applies the rule to MAC data packets with any destination address.
- ▶ Valid MAC address  
The device applies the rule to MAC data packets with the specified destination address. You use the `?` character as a wild card.  
Example `00:11:?:?:?:?:?:?`: The device applies the rule to MAC data packets whose destination address begins with `00:11`.
- ▶ Valid MAC address/bit mask  
The device applies the rule to MAC data packets with the specified source address. The bit mask lets you specify the address range with bit-level accuracy.  
Example `00:11:22:33:44:54/FF:FF:FF:FF:FF:FC`: The device applies the rule to MAC data packets with a destination address in the range from `00:11:22:33:44:54` to `...:57`.

#### Action

Specifies how the device processes received MAC data packets when the device applies the rule.

Possible values:

- ▶ `permit` (default setting)  
The device transmits the MAC data packets.
- ▶ `deny`  
The device discards the MAC data packets.

#### Log

Activates/deactivates the logging in the log file. See the [Diagnostics > Report > System Log](#) dialog.

Possible values:

- ▶ `marked`  
Logging is activated.  
The prerequisite is that you assign the Access Control List in the [Network Security > ACL > Assignment](#) dialog to a VLAN or port.  
The device registers in the log file, in an interval of 30 s, how many times it applied the deny rule to MAC data packets.
- ▶ `unmarked` (default setting)  
Logging is deactivated.

The device lets you activate this function for up to 128 deny rules.

## Buttons

You find the description of the standard buttons in section [“Buttons” on page 14](#).



Opens the [Create](#) window to add a new entry to the table.

- ▶ In the [Group name](#) field, you specify the name of the Access Control List to which the rule belongs.
- ▶ In the [Index](#) field, you specify the number of the rule within the Access Control List. If the Access Control List contains multiple rules, then the device processes the rule with the lowest value first.

## 4.6.3 ACL Assignment

[Network Security > ACL > Assignment]

This dialog lets you assign one or more Access Control Lists to the ports and VLANs of the device. By assigning a priority you specify the processing sequence, provided you assign one or more Access Control Lists to a port or VLAN.

The device applies rules successively, namely in the sequence specified by the rule index. You specify the priority of a group in the *Priority* column. The lower the number, the higher the priority. In this process, the device applies the rules with a high priority before the rules with a low priority.

The assignment of Access Control Lists to ports and VLANs results in the following different types of ACL:

- ▶ Port-based IPv4-ACLs
- ▶ Port-based MAC ACLs
- ▶ VLAN-based IPv4 ACLs
- ▶ VLAN-based MAC ACLs

The device lets you apply the Access Control Lists to data packets received (*inbound*).

**Note:** Before you enable the function, verify that at least one active entry in the table lets you access. Otherwise, the connection to the device terminates if you change the settings. To access the device management is possible only using the CLI through the serial interface of the device.

### Table

Group name

Displays the name of the Access Control List. The Access Control List contains the rules.

Type

Displays if the Access Control List contains MAC rules or IPv4 rules.

Possible values:

- ▶ *mac*  
The Access Control List contains MAC rules.
- ▶ *ip*  
The Access Control List contains IPv4 rules.

You edit Access Control Lists with IPv4 rules in the *Network Security > ACL > IPv4 Rule* dialog. You edit Access Control Lists with MAC rules in the *Network Security > ACL > MAC Rule* dialog.

Port

Displays the port to which the Access Control List is assigned. The field remains empty when the Access Control List is assigned to a VLAN.

VLAN ID

Displays the VLAN to which the Access Control List is assigned. The field remains empty when the Access Control List is assigned to a port.

#### Direction

Displays that the device applies the Access Control List to received data packets.

#### Priority

Displays the priority of the Access Control List.

Using the priority, you specify the sequence in which the device applies the Access Control Lists to the data stream. The device applies the rules in ascending order starting with priority 1.

Possible values:

- ▶ 1..4294967295

If an Access Control List is assigned to a port and to a VLAN with the same priority, then the device applies the rules to the port first.

#### Active

Displays if the Access Control List on the port or in the VLAN is active.

Possible values:

- ▶ `marked` (default setting)  
The Access Control List is active.
- ▶ `unmarked`  
The Access Control List is inactive.

### Buttons

You find the description of the standard buttons in section [“Buttons” on page 14](#).



Opens the [Create](#) dialog to assign a rule to a port or a VLAN.

- ▶ In the [Port/VLAN](#) field, you specify the port or the VLAN ID.
- ▶ In the [Priority](#) field, you specify the source MAC address of the ARP rule.
- ▶ In the [Direction](#) field, you specify the data packets to which the device applies the rule.
- ▶ In the [Group name](#) field, you specify which rule the device assigns to the port or VLAN.

## 5 Switching

The menu contains the following dialogs:

- ▶ Switching Global
- ▶ Rate Limiter
- ▶ Filter for MAC Addresses
- ▶ IGMP Snooping
- ▶ Time-Sensitive Networking
- ▶ MRP-IEEE
- ▶ QoS/Priority
- ▶ VLAN
- ▶ L2-Redundancy

### 5.1 Switching Global

[Switching > Global]

This dialog lets you specify the following settings:

- ▶ Change the Aging time of the address table
- ▶ Enable the flow control in the device
- ▶ Enable the VLAN Unaware Mode

If a large number of data packets are received in the priority queue of a port at the same time, then this can cause the port memory to overflow. This happens, for example, when the device receives data on a Gigabit port and forwards it to a port with a lower bandwidth. The device discards surplus data packets.

The flow control mechanism described in standard IEEE 802.3 helps ensure that no data packets are lost due to a port memory overflowing. Shortly before a port memory is completely full, the device signals to the connected devices that it is not accepting any more data packets from them.

- ▶ In full-duplex mode, the device sends a pause data packet.
- ▶ In half-duplex mode, the device simulates a collision.

Then the connected devices do not send any more data packets for as long as the signaling takes. On uplink ports, this can possibly cause undesired sending breaks in the higher-level network segment (“wandering backpressure”).

According to standard IEEE 802.1Q, the device forwards data packets with a VLAN tag in a VLAN  $\geq 1$ . However, a small number of applications on connected end devices send or receive data packets with a VLAN ID=0. When the device receives one of these data packets, before forwarding it the device overwrites the original value in the data packet with the VLAN ID of the receiving port. If you activate the VLAN Unaware Mode, then this deactivates the VLAN settings in the device. The device then transparently forwards the data packets and evaluates the priority information contained only in the data packet.

#### Configuration

MAC address

Displays the MAC address of the device.



#### Aging time [s]

Specifies the aging time in seconds.

Possible values:

- ▶ 10..500000 (default setting: 30)

The device monitors the age of the learned unicast MAC addresses. The device deletes address entries that exceed a particular age (aging time) from its address table.

You find the address table in the [Switching > Filter for MAC Addresses](#) dialog.

#### Flow control

Activates/deactivates the flow control in the device.

Possible values:

- ▶ `marked`  
The flow control is active in the device.  
Additionally activate the flow control on the required ports. See the [Basic Settings > Port](#) dialog, [Configuration](#) tab, checkbox in the [Flow control](#) column.
- ▶ `unmarked` (default setting)  
The flow control is inactive in the device.

If you are using a redundancy function, then deactivate the flow control on the participating ports. If the flow control and the redundancy function are active at the same time, it is possible that the redundancy function operates differently than intended.

#### VLAN unaware mode

Activates/deactivates the VLAN unaware mode.

Possible values:

- ▶ `marked`  
The VLAN unaware mode is active.  
The device works in the VLAN Unaware bridging mode (IEEE 802.1Q):
  - The device ignores the VLAN settings in the device and the VLAN tags in the data packets. The device transmits the data packets based on their destination MAC address or destination IP address in VLAN 1.
  - The device ignores the VLAN settings specified in the [Switching > VLAN > Configuration](#) and [Switching > VLAN > Port](#) dialogs. Every port is assigned to VLAN 1.
  - The device evaluates the priority information contained in the data packet.

**Note:** You specify the VLAN ID 1 for every function in the device which uses VLAN settings. Among other things, this applies to static filters, MRP and IGMP Snooping.

- ▶ `unmarked` (default setting)  
The VLAN unaware mode is inactive.  
The device works in the VLAN-aware bridging mode (IEEE 802.1Q):
  - The device evaluates the VLAN tags in the data packets.
  - The device transmits the data packets based on their destination MAC address or destination IP address in the corresponding VLAN.
  - The device evaluates the priority information contained in the data packet.

## **Buttons**

You find the description of the standard buttons in section [“Buttons” on page 14](#).

## 5.2 Rate Limiter

[Switching > Rate Limiter]

The device lets you limit the traffic on the ports in order to help provide stable operation even with a large traffic volume. If the traffic on a port exceeds the traffic value entered, then the device discards the excess traffic on this port.

The rate limiter function operates only on Layer 2, and is used to limit the effects of storms of data packets that flood the device (typically Broadcasts).

The rate limiter function ignores protocol information on higher layers, such as IP or TCP.

The dialog contains the following tabs:

- ▶ [Ingress]
- ▶ [Egress]

### [Ingress]

In this tab you enable the *Rate Limiter* function. The threshold value specifies the maximum amount of traffic the port receives. If the traffic on this port exceeds the threshold value, then the device discards the excess traffic on this port.

#### Table

Port

Displays the port number.

Threshold unit

Specifies the unit for the threshold value:

Possible values:

- ▶ *percent* (default setting)  
Specifies the threshold value as a percentage of the data rate of the port.
- ▶ *pps*  
Specifies the threshold value in data packets per second.

Broadcast mode

Activates/deactivates the rate limiter function for received broadcast data packets.

Possible values:

- ▶ *marked*
- ▶ *unmarked* (default setting)

If the threshold value is exceeded, then the device discards the excess broadcast data packets on this port.

#### Broadcast threshold

Specifies the threshold value for received broadcasts on this port.

Possible values:

- ▶ `0..14880000` (default setting: 0)

The value 0 deactivates the rate limiter function on this port.

- If you select the value *percent* in the *Threshold unit* column, then enter a percentage value from 1 to 100.
- If you select the value *pps* in the *Threshold unit* column, then enter an absolute value for the data rate.

#### Multicast mode

Activates/deactivates the rate limiter function for received multicast data packets.

Possible values:

- ▶ `marked`
- ▶ `unmarked` (default setting)

If the threshold value is exceeded, then the device discards the excess multicast data packets on this port.

#### Multicast threshold

Specifies the threshold value for received multicasts on this port.

Possible values:

- ▶ `0..14880000` (default setting: 0)

The value 0 deactivates the rate limiter function on this port.

- If you select the value *percent* in the *Threshold unit* column, then enter a percentage value from 0 to 100.
- If you select the value *pps* in the *Threshold unit* column, then enter an absolute value for the data rate.

#### Unknown unicast mode

Activates/deactivates the rate limiter function for received unicast data packets with an unknown destination address.

Possible values:

- ▶ `marked`
- ▶ `unmarked` (default setting)

If the threshold value is exceeded, then the device discards the excess unicast data packets on this port.

#### Unicast threshold

Specifies the threshold value for received unicasts with an unknown destination address on this port.

Possible values:

- ▶ `0..14880000` (default setting: 0)

The value 0 deactivates the rate limiter function on this port.

- If you select the value *percent* in the *Threshold unit*, then enter a percentage value from 0 to 100.
- If you select the value *pps* in the *Threshold unit* column, then enter an absolute value for the data rate.

### Buttons

You find the description of the standard buttons in section [“Buttons” on page 14](#).

### [Egress]

In this tab you specify the egress transmission rate on the port.

### Table

Port

Displays the port number.

Bandwidth [%]

Specifies the egress transmission rate.

Possible values:

- ▶ 0 (default setting)  
The bandwidth limitation is disabled.
- ▶ 1..100  
The bandwidth limitation is enabled.  
This value specifies the percentage of overall link speed for the port in 1% increments.

### Buttons

You find the description of the standard buttons in section [“Buttons” on page 14](#).

## 5.3 Filter for MAC Addresses

[Switching > Filter for MAC Addresses]

This dialog lets you display and edit address filters for the address table. Address filters specify the way the data packets are forwarded in the device based on the destination MAC address.

Each row in the table represents one filter. The device automatically sets up the filters. The device lets you set up additional filters manually.

The device transmits the data packets as follows:

- ▶ When the table contains an entry for the destination address of a data packet, the device transmits the data packet from the receiving port to the port specified in the table entry.
- ▶ When there is no table entry for the destination address, the device transmits the data packet from the receiving port to every other port.

### Table

To delete the learned MAC addresses from the address table, click in the [Basic Settings > Restart](#) dialog the [Reset MAC address table](#) button.

#### Address

Displays the destination MAC address to which the table entry applies.

#### VLAN ID

Displays the ID of the VLAN to which the table entry applies.

The device learns the MAC addresses for every VLAN separately (independent VLAN learning).

#### Status

Displays how the device has set up the address filter.

Possible values:

- ▶ *learned*  
Address filter set up automatically by the device based on received data packets.
- ▶ *permanent*  
Address filter set up manually. The address filter stays set up permanently.
- ▶ *IGMP*  
Address filter automatically set up by IGMP Snooping.
- ▶ *mgmt*  
MAC address of the device. The address filter is protected against changes.
- ▶ *MRP-MMRP*  
Multicast address filter automatically set up by MMRP.

<Port number>

Displays how the corresponding port transmits data packets which it directs to the adjacent destination address.

Possible values:

- ▶ `-`  
The port does not transmit any data packets to the destination address.
- ▶ `learned`  
The port transmits data packets to the destination address. The device created the filter automatically based on received data packets.
- ▶ `IGMP learned`  
The port transmits data packets to the destination address. The device created the filter automatically based on IGMP.
- ▶ `unicast static`  
The port transmits data packets to the destination address. A user created the filter.
- ▶ `multicast static`  
The port transmits data packets to the destination address. A user created the filter.

## Buttons

You find the description of the standard buttons in section [“Buttons” on page 14](#).



Opens the [Create](#) window to add a new entry to the table.

- ▶ In the [Address](#) field, you specify the destination MAC address.
- ▶ In the [VLAN ID](#) field, you specify the ID of the VLAN.
- ▶ In the [Port](#) field, you specify the port.
  - Select one port if the destination MAC address is a unicast address.
  - Select one or more ports if the destination MAC address is a multicast address.
  - Select no port to create a discard filter. The device discards data packets with the destination MAC address specified in the table entry.

Reset MAC address table

Removes the MAC addresses from the forwarding table that have the value `learned` in the [Status](#) column.

## 5.4 IGMP Snooping

[ Switching > IGMP Snooping ]

The Internet Group Management Protocol (IGMP) is a protocol for dynamically managing Multicast groups. The protocol describes the distribution of Multicast data packets between routers and end devices on Layer 3.

The device lets you use the IGMP Snooping function to also use the IGMP mechanisms on Layer 2:

- ▶ Without IGMP Snooping, the device transmits the Multicast data packets to every port.
- ▶ With the activated IGMP Snooping function, the device transmits the Multicast data packets only on ports to which Multicast receivers are connected. This reduces the network load. The device evaluates the IGMP data packets transmitted on Layer 3 and uses the information on Layer 2.

Activate the IGMP Snooping function not until the following conditions are fulfilled:

- ▶ There is a Multicast router in the network that creates IGMP queries (periodic queries).
- ▶ The devices participating in IGMP Snooping forward the IGMP queries.

The device links the IGMP reports with the entries in its address table. When a multicast receiver joins a multicast group, the device creates a table entry for this port in the [Switching > Filter for MAC Addresses](#) dialog. When the multicast receiver leaves the multicast group, the device removes the table entry.

The menu contains the following dialogs:

- ▶ [IGMP Snooping Global](#)
- ▶ [IGMP Snooping Configuration](#)
- ▶ [IGMP Snooping Enhancements](#)
- ▶ [IGMP Snooping Querier](#)
- ▶ [IGMP Snooping Multicasts](#)



## 5.4.1 IGMP Snooping Global

[Switching > IGMP Snooping > Global]

This dialog lets you enable the *IGMP Snooping* protocol in the device and also configure it for each port and each VLAN.

### Operation

#### Operation

Enables/disables the *IGMP Snooping* function in the device.

Possible values:

- ▶ *On*  
The *IGMP Snooping* function is enabled in the device according to RFC 4541 (Considerations for Internet Group Management Protocol (IGMP) and Multicast Listener Discovery (MLD) Snooping Switches).
- ▶ *Off* (default setting)  
The *IGMP Snooping* function is disabled in the device.  
The device transmits received query, report, and leave data packets without evaluating them. Received data packets with a Multicast destination address are transmitted to every port by the device.

### Information

#### Multicast control packets processed

Displays the number of Multicast control data packets processed.

This statistic encompasses the following packet types:

- IGMP Reports
- IGMP Queries version V1
- IGMP Queries version V2
- IGMP Queries version V3
- IGMP Queries with an incorrect version
- PIM or DVMRP packets

The device uses the Multicast control data packets to create the address table for transmitting the Multicast data packets.

Possible values:

- ▶  $0..2^{31}-1$

You use the *Reset IGMP snooping data* button in the *Basic Settings > Restart* dialog or the command `clear igmp-snooping` using the Command Line Interface to reset the IGMP Snooping entries, including the counter for the processed multicast control data packets.

## Buttons

You find the description of the standard buttons in section [“Buttons”](#) on page 14.

### Reset IGMP snooping counters

Removes the IGMP Snooping entries and resets the counter in the *Information* frame to 0.

## 5.4.2 IGMP Snooping Configuration

[Switching > IGMP Snooping > Configuration]

This dialog lets you enable the *IGMP Snooping* function in the device and also configure it for each port and each VLAN.

The dialog contains the following tabs:

- ▶ [VLAN ID]
- ▶ [Port]

### [VLAN ID]

In this tab you configure the *IGMP Snooping* function for every VLAN.

#### Table

##### VLAN ID

Displays the ID of the VLAN to which the table entry applies.

##### Active

Activates/deactivates the *IGMP Snooping* function for this VLAN.

The prerequisite is that the *IGMP Snooping* function is globally enabled.

Possible values:

- ▶ *marked*  
IGMP Snooping is activated for this VLAN. The VLAN has joined the Multicast data stream.
- ▶ *unmarked* (default setting)  
IGMP Snooping is deactivated for this VLAN. The VLAN has left the Multicast data stream.

##### Group membership interval

Specifies the time in seconds for which a VLAN from a dynamic Multicast group remains entered in the address table when the device does not receive any more report data packets from the VLAN.

Specify a value larger than the value in the *Max. response time* column.

Possible values:

- ▶ *2..3600* (default setting: *260*)

##### Max. response time

Specifies the time in seconds in which the members of a multicast group should respond to a query data packet. For their response, the members specify a random time within the response time. You thus help prevent the multicast group members from responding to the query at the same time.

Specify a value smaller than the value in the *Group membership interval* column.

Possible values:

- ▶ 1..25 (default setting: 10)

#### Fast leave admin mode

Activates/deactivates the Fast Leave function for this VLAN.

Possible values:

- ▶ `marked`  
When the Fast Leave function is active and the device receives an IGMP Leave message from a multicast group, the device immediately removes the entry from its address table.
- ▶ `unmarked` (default setting)  
When the Fast Leave function is inactive, the device first sends MAC-based queries to the members of the multicast group and removes an entry when a VLAN does not send any more report messages.

#### MRP expiration time

Multicast Router Present Expiration Time. Specifies the time in seconds for which the device waits for a query on this port that belongs to a VLAN. When the port does not receive a query data packet, the device removes the port from the list of ports with connected multicast routers.

You have the option of configuring this parameter only if the port belongs to an existing VLAN.

Possible values:

- ▶ 0  
unlimited timeout - no expiration time
- ▶ 1..3600 (default setting: 260)

### Buttons

You find the description of the standard buttons in section [“Buttons” on page 14](#).

### [Port]

In this tab you configure the *IGMP Snooping* function for every port.

### Table

Port

Displays the port number.

Active

Activates/deactivates the *IGMP Snooping* function for this port.

The prerequisite is that the *IGMP Snooping* function is globally enabled.

Possible values:

- ▶ `marked`  
IGMP Snooping is active on this port. The device includes the port in the multicast data stream.
- ▶ `unmarked` (default setting)  
IGMP Snooping is inactive on this port. The port left the multicast data stream.

#### Group membership interval

Specifies the time in seconds for which a port, from a dynamic multicast group, remains entered in the address table when the device does not receive any more report data packets from the port.

Possible values:

- ▶ `2..3600` (default setting: `260`)

Specify the value larger than the value in the *Max. response time* column.

#### Max. response time

Specifies the time in seconds in which the members of a multicast group should respond to a query data packet. For their response, the members specify a random time within the response time. You thus help prevent the multicast group members from responding to the query at the same time.

Possible values:

- ▶ `1..25` (default setting: `10`)

Specify a value lower than the value in the *Group membership interval* column.

#### MRP expiration time

Specifies the Multicast Router Present Expiration Time. The MRP expiration time is the time in seconds for which the device waits for a query packet on this port. When the port does not receive a query data packet, the device removes the port from the list of ports with connected multicast routers.

Possible values:

- ▶ `0`  
unlimited timeout - no expiration time
- ▶ `1..3600` (default setting: `260`)

#### Fast leave admin mode

Activates/deactivates the Fast Leave function for this port.

Possible values:

- ▶ `marked`  
When the Fast Leave function is active and the device receives an IGMP Leave message from a multicast group, the device immediately removes the entry from its address table.
- ▶ `unmarked` (default setting)  
When the Fast Leave function is inactive, the device first sends MAC-based queries to the members of the multicast group and removes an entry when a port does not send any more report messages.

#### Static query port

Activates/deactivates the *Static query port* mode.

Possible values:

- ▶ `marked`  
The *Static query port* mode is active.  
The port is a static query port in the VLANs that are set up.
- ▶ `unmarked` (default setting)  
The *Static query port* mode is inactive.  
The port is not a static query port. The device transmits IGMP report messages to the port only if it receives IGMP queries.

#### VLAN IDs

Displays the ID of the VLANs to which the table entry applies.

### Buttons

You find the description of the standard buttons in section [“Buttons” on page 14](#).

### 5.4.3 IGMP Snooping Enhancements

[Switching > IGMP Snooping > Snooping Enhancements]

This dialog lets you select a port for a VLAN ID and to configure the port.

#### Table

VLAN ID

Displays the ID of the VLAN to which the table entry applies.

<Port number>

Displays for every VLAN set up in the device if the relevant port is a query port. Additionally, the field displays if the device transmits every Multicast stream in the VLAN to this port.

Possible values:

- ▶ -  
The port is not a query port in this VLAN.
- ▶ **L**= Learned  
The device detected the port as a query port because the port received IGMP queries in this VLAN. The port is not a statically configured query port.
- ▶ **A**= Automatic  
The device detected the port as a query port. The prerequisite is that you configure the port as *Learn by LLDP*.
- ▶ **S**= Static (manual setting)  
A user specified the port as a static query port. The device transmits IGMP reports only to ports on which it previously received IGMP queries – and to statically configured query ports.  
To assign this value, perform the following steps:
  - Open the *Wizard* window.
  - In the *Configuration* dialog, mark the *Static* checkbox.
- ▶ **P**= Learn by LLDP (manual setting)  
A user specified the port as *Learn by LLDP*.  
With the Link Layer Discovery Protocol (LLDP), the device detects Hirschmann devices connected directly to the port. The device denotes the detected query ports with **A**.  
To assign this value, perform the following steps:
  - Open the *Wizard* window.
  - In the *Configuration* dialog, mark the *Learn by LLDP* checkbox.
- ▶ **F**= Forward All (manual setting)  
A user specified the port so that the device transmits every received Multicast stream in the VLAN to this port. Use this setting for diagnostics purposes, for example.  
To assign this value, perform the following steps:
  - Open the *Wizard* window.
  - In the *Configuration* dialog, mark the *Forward all* checkbox.

Display categories

Enhances the clarity of the display. The table emphasizes the cells which contain the specified value. This helps to analyze and sort the table according to your needs.

- ▶ *Learned (L)*  
The table displays cells which contain the value **L** and possibly further values. Cells which contain other values than **L** only, the table displays with the “-“ symbol.

- ▶ *Static (S)*  
The table displays cells which contain the value **S** and possibly further values. Cells which contain other values than **S** only, the table displays with the “-” symbol.
- ▶ *Automatic (A)*  
The table displays cells which contain the value **A** and possibly further values. Cells which contain other values than **A** only, the table displays with the “-” symbol.
- ▶ *Learned by LLDP (P)*  
The table displays cells which contain the value **P** and possibly further values. Cells which contain other values than **P** only, the table displays with the “-” symbol.
- ▶ *Forward all (F)*  
The table displays cells which contain the value **F** and possibly further values. Cells which contain other values than **F** only, the table displays with the “-” symbol.

## Buttons

You find the description of the standard buttons in section “Buttons” on page 14.



Opens the *Wizard* window that helps you to select and configure the ports.

### [Selection VLAN/Port (Wizard)]

In the *Selection VLAN/Port* dialog you assign a VLAN ID to port.

In the *Configuration* dialog you specify the settings for the port.

After closing the *Wizard* window, click the  button to save your settings.



**[Selection VLAN/Port (Wizard) – Selection VLAN/Port]**

## VLAN ID

Select the ID of the VLAN.

Possible values:

▶ 1..4042

## Port

Select the port.

Possible values:

▶ <Port number>

**[Selection VLAN/Port (Wizard) – Configuration]**

## VLAN ID

Displays the ID of the selected VLAN.

## Port

Displays the number of the selected port.

## Static

Specifies the port as a static query port in the VLANs that are set up. The device transmits IGMP report messages to the ports at which it receives IGMP queries. This lets you also transmit IGMP report messages to other selected ports (enable) or connected Hirschmann devices ([Automatic](#)).

## Learn by LLDP

Specifies the port as [Learn by LLDP](#). Lets the device detect directly connected Hirschmann devices using LLDP and learn the related ports as a query port.

## Forward all

Specifies the port as [Forward all](#). With the [Forward all](#) setting, the device transmits at this port every data packet with a Multicast address in the destination address field.

## 5.4.4 IGMP Snooping Querier

[ Switching > IGMP Snooping > Querier ]

The device lets you send a Multicast stream only to those ports to which a Multicast receiver is connected.

To determine which ports Multicast receivers are connected to, the device sends query data packets to the ports at a definable interval. When a Multicast receiver is connected, it joins the Multicast stream by responding to the device with a report data packet.

This dialog lets you configure the Snooping Querier settings globally and for the VLANs that are set up.

### Operation

Operation

Enables/disables the IGMP Querier function globally in the device.

Possible values:

- ▶ *On*
- ▶ *Off* (default setting)

### Configuration

In this frame you specify the IGMP Snooping Querier settings for the general query data packets.

Protocol version

Specifies the IGMP version of the general query data packets.

Possible values:

- ▶ *1*  
IGMP v1
- ▶ *2* (default setting)  
IGMP v2
- ▶ *3*  
IGMP v3

### Query interval [s]

Specifies the time in seconds after which the device generates general query data packets itself when it has received query data packets from the Multicast router.

Possible values:

- ▶ 1..1800 (default setting: 60)

### Expiry interval [s]

Specifies the time in seconds after which an active querier switches from the passive state back to the active state if it has not received any query packets for longer than specified here.

Possible values:

- ▶ 60..300 (default setting: 125)

## Table

In the table you specify the Snooping Querier settings for the VLANs that are set up.

### VLAN ID

Displays the ID of the VLAN to which the table entry applies.

### Active

Activates/deactivates the IGMP Snooping Querier function for this VLAN.

Possible values:

- ▶ `marked`  
The IGMP Snooping Querier function is active for this VLAN.
- ▶ `unmarked` (default setting)  
The IGMP Snooping Querier function is inactive for this VLAN.

### Current state

Displays if the Snooping Querier is active for this VLAN.

Possible values:

- ▶ `marked`  
The Snooping Querier is active for this VLAN.
- ▶ `unmarked`  
The Snooping Querier is inactive for this VLAN.

#### Address

Specifies the IP address that the device adds as the source address in generated general query data packets. You use the address of the multicast router.

Possible values:

- ▶ Valid IPv4 address (default setting: 0.0.0.0)

#### Protocol version

Displays the IGMP protocol version of the general query data packets.

Possible values:

- ▶ 1  
IGMP v1
- ▶ 2  
IGMP v2
- ▶ 3  
IGMP v3

#### Max. response time

Displays the time in seconds in which the members of a Multicast group should respond to a query data packet. For their response, the members specify a random time within the response time. This helps prevent every Multicast group member to respond to the query at the same time.

#### Last querier address

Displays the IP address of the Multicast router from which the last received IGMP query was sent out..

#### Last querier version

Displays the IGMP version that the Multicast router used when sending out the last IGMP query received in this VLAN.

### Buttons

You find the description of the standard buttons in section [“Buttons” on page 14](#).

## 5.4.5 IGMP Snooping Multicasts

[Switching > IGMP Snooping > Multicasts]

The device lets you specify how it transmits data packets with unknown Multicast addresses: Either the device discards these data packets, floods them to every port, or transmits them only to the ports that previously received query packets.

The device also lets you transmit the data packets with known Multicast addresses to the query ports.

### Configuration

#### Unknown multicasts

Specifies how the device transmits the data packets with unknown Multicast addresses.

Possible values:

- ▶ *Discard*  
The device discards data packets with an unknown MAC/IP Multicast address.
- ▶ *Send to all ports* (default setting)  
The device forwards data packets with an unknown MAC/IP Multicast address to every port.
- ▶ *Send to query ports*  
The device forwards data packets with an unknown MAC/IP Multicast address to the query ports.

### Table

In the table you specify the settings for known Multicasts for the VLANs that are set up.

#### VLAN ID

Displays the ID of the VLAN to which the table entry applies.

#### Known multicasts

Specifies how the device transmits the data packets with known Multicast addresses.

Possible values:

- ▶ *send to query and registered ports*  
The device forwards data packets with an unknown MAC/IP Multicast address to the query ports and to the registered ports.
- ▶ *send to registered ports* (default setting)  
The device forwards data packets with an unknown MAC/IP Multicast address to registered ports.

## Buttons

You find the description of the standard buttons in section [“Buttons” on page 14](#).

## 5.5 Time-Sensitive Networking

[Switching > TSN]

The menu contains the following dialogs:

- ▶ [TSN Configuration](#)
- ▶ [TSN Service Data Unit](#)
- ▶ [TSN Gate Control List](#)

## 5.5.1 TSN Configuration

[Switching > TSN > Configuration]

In this dialog you enable the *TSN* function and specify the time-specific settings.

The device supports time-aware queuing defined in IEEE 802.1 Qbv. This *TSN* feature lets the TSN-capable ports transmit data packets of every traffic class scheduled relative to a defined cycle in the Gate Control List. The VLAN tag of an Ethernet packet – or the port priority in case of an untagged packet – contains the priority.

The feature helps to avoid latency and congestion loss for reserved data streams. The precise synchronization of cycles and gate states using IEEE1588 (PTP) makes congestion-free, low-latency communication possible. The prerequisite is that every device in the network supports IEEE 802.1 Qbv.

**Note:** In contrast to the Command Line Interface, you commit the settings immediately if you click the  button.

### Operation

Operation

Enables/disables the *TSN* function in the device.

Possible values:

▶ *On*

The *TSN* function is globally enabled.

For restrictions on the TSN-capable ports see section “Restrictions on TSN-capable ports” on page 217.

The device processes link local frames on the TSN-capable ports with the priority of traffic class 6. As a result, the link local frames compete with other data packets with the same or higher priority when forwarding. This affects the following frame types:

- RSTP
- LLDP
- IEEE 802.1AS
- PTP Peer Delay

▶ *Off* (default setting)

The *TSN* function is globally disabled.

### Table

Port

Displays the port number.

## Active

Activates/deactivates the *TSN* function on the port.

Possible values:

- ▶ *marked*  
The *TSN* function is active on the port. When you specify the base time in the future, the cycle starts at the time specified in the *Base time* columns.  
The prerequisite is that the *PTP* function is enabled and the device is synchronized.  
As long as the *TSN* function is globally enabled, the port uses the cycle specified in the *Switching > TSN > Gate Control List > Configured* dialog.
- ▶ *unmarked* (default setting)  
The *TSN* function is inactive on the port.  
As long as the *TSN* function is globally enabled, the port uses the gate states specified in the *Default gate states* column.

## Default gate states

Specifies the opened gates in case the *TSN* function on the port is inactive.

- The data packets whose traffic class is assigned to a selected gate are selected for transmission – Gate state OPEN.
- The data packets whose traffic class is assigned to a not selected gate are not selected for transmission – Gate state CLOSED.

Possible values:

- ▶ -  
No gate selected.  
The device does not open any gate on the port. In the drop-down list, unselect every gate.
- ▶ 0..7 (default setting: 0, 1, 2, 3, 4, 5, 6, 7)  
The device opens the selected gates on the port. In the drop-down list, select one or more gates.  
You assign the VLAN priorities to a traffic class in the *Switching > QoS/Priority > 802.1D/p Mapping* dialog.

## Port state

Displays the status of the cycle on the port.

Possible values:

- ▶ *running*  
The cycle is running.  
The port uses the cycle specified in the *Switching > TSN > Gate Control List > Configured* dialog.
- ▶ *waitForTimeSync*  
The cycle has not yet started.  
The clock of the device is not synchronized.  
Check the *PTP* settings.
- ▶ *pending*  
The cycle has not yet started.  
The base time is specified in the future.
- ▶ *disabled*  
The cycle is not running.  
The *TSN* function is inactive on the port.



- Check the setting in the [Operation](#) frame.
  - Check the setting in the [Active](#) column.
- The port uses the gate states specified in the [Default gate states](#) column.

▶ [error](#)

The cycle is not running.  
An error has occurred.

## Cycle time [ns]

## Configured

Specifies the duration of a cycle in nanoseconds.

## Possible values:

- ▶ [1000..1000000000](#) (default setting: [1000000](#))
- 1  $\mu$ s .. 1 s

## Current

Displays the duration of the current cycle in nanoseconds.

## Base time

## Date

## Time

## [ns]

Specifies the time at which the cycle starts related to the UTC time.

The device converts the value into the PTP time scale directly without considering the leap seconds.

## Possible values:

- ▶ [MM/DD/YY](#)  
Month/Day/Year  
(depending on the language preferences of your web browser)
- ▶ [hh:mm:ss](#)  
Hour:Minute:Second
- ▶ [0..999999999](#)  
Specifies the offset of nanoseconds.

**Note:** When you specify the base time in the future, the cycle starts as many seconds earlier than specified in the [UTC offset \[s\]](#) field. See the [Time > PTP > Boundary Clock > Global](#) dialog.

## Current

Displays the base time to which the cycle currently refers.

This value relates to the PTP time.

If no cycle was started at all, then the displayed time corresponds to the start time of the PTP epoch ([Jan 1, 1970, 12:00:00 AM](#)).

Time of last activation

Displays the date and time at which the time settings became active last time.

This value relates to the PTP time.

**Buttons**

You find the description of the standard buttons in section “Buttons” on page 14.

**Restrictions on TSN-capable ports**

As long as the *TSN* function is globally enabled, the following restrictions apply to the TSN-capable ports:

- The TSN-capable ports share a common MAC address table (FDB) with a maximum of 256 entries.
- For the *PTP* function, the TSN-capable port 1/3 does not support the *UDP/IPv4* protocol. See the *Time > PTP > Boundary Clock > Port* dialog, *Network protocol* column.

Restricted function	See dialog
<i>802.1X Port Authentication</i>	<i>Network Security &gt; 802.1X Port Authentication</i>
<i>ACL</i>	<i>Network Security &gt; ACL</i>
<i>DHCP L2 Relay</i>	<i>Advanced &gt; DHCP L2 Relay</i>
<i>DHCP Server port and VLAN settings</i>	<i>Advanced &gt; DHCP Server</i>
<i>DoS</i>	<i>Network Security &gt; DoS</i>
<i>Flow control</i>	<i>Basic Settings &gt; Port</i>
<i>IGMP Snooping</i>	<i>Switching &gt; IGMP Snooping</i>
<i>Link Aggregation</i>	<i>Switching &gt; L2-Redundancy &gt; Link Aggregation</i>
<i>MTU</i>	<i>Basic Settings &gt; Port</i> [Use the <i>Max. SDU</i> parameter, see the <i>Switching &gt; TSN &gt; SDU</i> dialog.]
<i>Port (Statistics, Utilization)</i>	<i>Basic Settings &gt; Port</i>
<i>Port Mirroring</i>	<i>Diagnostics &gt; Ports &gt; Port Mirroring</i>
<i>Port Monitor (CRC/Fragments, Overload detection)</i>	<i>Diagnostics &gt; Ports &gt; Port Monitor</i>
<i>Port Security</i>	<i>Network Security &gt; Port Security</i>
<i>PROFINET</i>	<i>Advanced &gt; Industrial Protocols &gt; PROFINET</i>
<i>Queue Management</i>	<i>Switching &gt; QoS/Priority &gt; Queue Management</i>
<i>Rate Limiter</i>	<i>Switching &gt; Rate Limiter</i>
<i>Trust mode</i>	<i>Switching &gt; QoS/Priority &gt; Port Configuration</i>
<i>VLAN Voice</i>	<i>Switching &gt; VLAN &gt; Voice</i>

## 5.5.2 TSN Service Data Unit

[Switching > TSN > SDU]

In this dialog you specify for the TSN-capable ports the maximum allowed packet length per traffic class.

The dialog contains the following tabs:

- ▶ One tab for every TSN-capable port.  
The number of TSN-capable ports depends on the device.

### [<Port number>]

#### Table

Traffic class

Displays the number of the traffic class.

You assign the VLAN priorities to a traffic class in the [Switching > QoS/Priority > 802.1D/p Mapping](#) dialog.

Max. SDU

Specifies for the appropriate traffic class the maximum allowed length of the Ethernet packets in bytes.

If the *TSN* function is enabled, then the device uses this value instead of the *MTU* value. See the [Basic Settings > Port](#) dialog.

Possible values:

- ▶ 0 (default setting)  
Maximum allowed value, see below.
- ▶ 1..43  
The device does not forward any packet, because the allowed packet length is lower than the minimum Ethernet packet length.
- ▶ 44..1524  
Specify a maximum allowed length with which the data packets fit into the appropriate gate.

**Note:** The SDU includes the packet payload but excludes the source and destination MAC addresses (6 bytes each), the VLAN tag (4 bytes) and the FCS (4 bytes).

Example for a 64 bytes Ethernet packet: 64 bytes - 12 bytes (MAC) - 4 bytes (VLAN) - 4 bytes (FCS) = 44 bytes

#### Buttons

You find the description of the standard buttons in section [“Buttons” on page 14](#).

### 5.5.3 TSN Gate Control List

[Switching > TSN > Gate Control List]

The menu contains the following dialogs:

- ▶ [TSN Configured Gate Control List](#)
- ▶ [TSN Current Gate Control List](#)

### 5.5.3.1 TSN Configured Gate Control List

[Switching > TSN > Gate Control List > Configured]

In this dialog you specify the time slots of the cycle for the TSN-capable ports. Adding a table entry you specify the opened gates and the duration of the time slot.

**Note:** In contrast to the Command Line Interface, you commit the settings immediately if you click the  button.

The dialog contains the following tabs:

- ▶ One tab for every TSN-capable port.  
The number of TSN-capable ports depends on the device.

[<Port number>]

#### Table

Index

Displays the index number of the entry in the Gate Control List, which specifies the chronological order of the timeslots.

Gate states

Specifies the opened gates in case the *TSN* function on the port is active.

- The data packets whose traffic class is assigned to a selected gate are selected for transmission – Gate state OPEN.
- The data packets whose traffic class is assigned to a not selected gate are not selected for transmission – Gate state CLOSED.

Possible values:

- ▶ - (default setting)  
No gate selected.  
The device does not open any gate on the port during the time slot is processed. In the drop-down list, unselect every gate.
- ▶ 0..7  
The device opens the selected gates on the port during the time slot is processed. In the drop-down list, select one or more gates.  
You assign the VLAN priorities to a traffic class in the *Switching > QoS/Priority > 802.1D/p Mapping* dialog.

Interval [ns]

Specifies the duration of the time slot in nanoseconds.

Possible values:

▶ 80..1000000000

When you specify the duration of the time slots, consider the following conditions:

- A single time slot
  - Confirm that a time slot is at least long enough for the port to transmit the longest expected data packet.
  - Confirm that a time slot is less than or equal to the duration of the cycle.
- The sum of the time slots specified
  - We recommend that the sum of the time slots is equal to the duration of the cycle.
  - If the sum exceeds the duration of the cycle, then the overlapping time slots are discarded and the cycle restarts.
  - If the sum is smaller than the duration of the cycle, then the interval of the last time slot is extended to fit into the cycle.

**Note:** Discrepancies between the specified time slots and the cycle duration are not highlighted in the [Switching > TSN > Gate Control List > Current](#) dialog.

## Buttons

You find the description of the standard buttons in section [“Buttons” on page 14](#).

### 5.5.3.2 TSN Current Gate Control List

[Switching > TSN > Gate Control List > Current]

In this dialog you monitor the current settings of the cycle for the TSN-capable ports. Every table entry represents a specified time slot.

If the time at which the cycle starts (*Base time*) is in the future, then the displayed values are different from the values specified in the [Switching > TSN > Gate Control List > Configured](#) dialog.

In the [Switching > TSN > Configuration](#) dialog, the *Port state* column displays if the cycle is running on a port.

The dialog contains the following tabs:

- ▶ One tab for every TSN-capable port.  
The number of TSN-capable ports depends on the device.

#### [<Port number>]

##### Table

Index

Displays the index number of the entry in the Gate Control List, which specifies the chronological order of the timeslots.

Gate states

Displays the opened gates in case the *TSN* function on the port is active.

Interval [ns]

Displays the duration of the time slot in nanoseconds.

##### Buttons

You find the description of the standard buttons in section [“Buttons” on page 14](#).

## 5.6 MRP-IEEE

[ Switching > MRP-IEEE ]

The IEEE 802.1ak amendment to the IEEE 802.1Q standard introduced the Multiple Registration Protocol (MRP) to replace the Generic Attribute Registration Protocol (GARP). The IEEE also modified and replaced the GARP applications, GARP Multicast Registration Protocol (GMRP) and GARP VLAN Registration Protocol (GVRP). The Multiple MAC Registration Protocol (MMRP) and the Multiple VLAN Registration Protocol (MVRP) replace these protocols.

MRP-IEEE helps confine traffic to the required areas of the LAN. To confine traffic, the MRP-IEEE applications distribute attribute values to participating MRP-IEEE devices across a LAN registering and de-registering multicast group membership and VLAN identifiers.

Registering group participants lets you reserve resources for specific traffic transversing a LAN. Defining resource requirements regulates the level of traffic, allowing the devices to determine the required resources and provides for dynamic maintenance of the allocated resources.

The menu contains the following dialogs:

- ▶ [MRP-IEEE Configuration](#)
- ▶ [MRP-IEEE Multiple MAC Registration Protocol](#)
- ▶ [MRP-IEEE Multiple VLAN Registration Protocol](#)



## 5.6.1 MRP-IEEE Configuration

[Switching > MRP-IEEE > Configuration]

This dialog lets you set the various MRP timers. By maintaining a relationship between the various timer values, the protocol operates efficiently and with less likelihood of unnecessary attribute withdraws and re-registrations. The default timer values effectively maintain these relationships.

When you reconfigure the timers, maintain the following relationships:

- ▶ To allow for re-registration after a Leave or LeaveAll event, even if there is a lost message, specify the LeaveTime to:  $\geq (2 \times \text{JoinTime}) + 60$ .
- ▶ To minimize the volume of rejoining traffic generated following a LeaveAll event, specify the value for the LeaveAll timer larger than the LeaveTime value.

### Table

Port

Displays the port number.

Join time [1/100s]

Specifies the Join timer which controls the interval between transmit opportunities applied to the Applicant state machine.

Possible values:

- ▶ 10..100 (default setting: 20)

Leave time [1/100s]

Specifies the Leave timer which controls the period that the Registrar state machine waits in the leave (LV) state before transiting to the empty (MT) state.

Possible values:

- ▶ 20..600 (default setting: 60)

Leave all time [1/100s]

Specifies the LeaveAll timer which controls the frequency with which the LeaveAll state machine generates LeaveAll PDUs.

Possible values:

- ▶ 200..6000 (default setting: 1000)

### Buttons

You find the description of the standard buttons in section [“Buttons” on page 14](#).

## 5.6.2 MRP-IEEE Multiple MAC Registration Protocol

[ Switching > MRP-IEEE > MMRP ]

The Multiple MAC Registration Protocol (MMRP) lets end devices and MAC switches register and de-register group membership and individual MAC address information with switches located in the same LAN. The switches within the LAN disseminate the information through switches that support extended filtering services. Using the MAC address information, MMRP lets you confine multicast traffic to the required areas of a Layer 2 network.

For an example of how MMRP works, consider a security camera mounted on a mast overlooking a building. The camera sends multicast packets onto a LAN. You have 2 end devices installed for surveillance in separate locations. You register the MAC addresses of the camera and the 2 end devices in the same multicast group. You then specify the MMRP settings on the ports to send the multicast group packets to the 2 end devices.

The dialog contains the following tabs:

- ▶ [\[ Configuration \]](#)
- ▶ [\[ Service requirement \]](#)
- ▶ [\[ Statistics \]](#)

### [ Configuration ]

In this tab you select active MMRP port participants and set the device to transmit periodic events. The dialog also lets you enable VLAN registered MAC address broadcasting.

A periodic state machine exists for each port and transmits periodic events regularly to the applicant state machines associated with active ports. Periodic events contain information indicating the status of the devices associated with the active port.

### Operation

#### Operation

Enables/disables the global *MMRP* function in the device. The device participates in MMRP message exchanges.

Possible values:

- ▶ *On*  
The device is a normal participant in MMRP message exchanges.
- ▶ *Off* (default setting)  
The device ignores MMRP messages.

## Configuration

### Periodic state machine

Enables/disables the global periodic state machine in the device.

Possible values:

- ▶ *On*  
With MMRP *Operation* enabled globally, the device transmits MMRP messages in one-second intervals, on MMRP participating ports.
- ▶ *Off* (default setting)  
Disables the periodic state machine in the device.

## Table

### Port

Displays the port number.

### Active

Activates/deactivates the port MMRP participation.

Possible values:

- ▶ *marked* (default setting)  
With MMRP enabled globally and on this port, the device sends and receives MMRP messages on this port.
- ▶ *unmarked*  
Disables the port MMRP participation.

### Restricted group registration

Activates/deactivates the restriction of dynamic MAC address registration using MMRP on the port.

Possible values:

- ▶ *marked*  
If enabled and a static filter entry for the MAC address exists on the VLAN concerned, then the device registers the MAC address attributes dynamically.
- ▶ *unmarked* (default setting)  
Activates/deactivates the restriction of dynamic MAC address registration using MMRP on the port.

## Buttons

You find the description of the standard buttons in section [“Buttons” on page 14](#).

## [Service requirement]

This tab contains forwarding parameters for each active VLAN, specifying the ports on which multicast forwarding applies. The device lets you statically setup VLAN ports as *Forward all* or *Forbidden*. You set the *Forbidden* MMRP service requirement statically only through the Graphical User Interface or Command Line Interface.

A port is setup only as *ForwardAll* or *Forbidden*.

### Table

VLAN ID

Displays the ID of the VLAN.

<Port number>

Specifies the service requirement handling for the port.

Possible values:

- ▶ *FA*  
Specifies the *ForwardAll* traffic setting on the port. The device forwards traffic destined to MMRP registered multicast MAC addresses on the VLAN. The device forwards traffic to ports which MMRP has dynamically setup or ports which the administrator has statically setup as *ForwardAll* ports.
- ▶ *F*  
Specifies the *Forbidden* traffic setting on the port. The device blocks dynamic MMRP *ForwardAll* service requirements. With *ForwardAll* requests blocked on this port in this VLAN, the device blocks traffic destined to MMRP registered multicast MAC addresses on this port. Furthermore, the device blocks MMRP service request for changing this value on this port.
- ▶ *-* (default setting)  
Disables the forwarding functions on this port.
- ▶ *Learned*  
Displays values setup by MMRP service requests.

### Buttons

You find the description of the standard buttons in section [“Buttons” on page 14](#).

## [Statistics]

Devices on a LAN exchange Multiple MAC Registration Protocol Data Units (MMRPDU) to maintain statuses of devices on an active MMRP port. This tab lets you monitor the MMRP traffic statistics for each port.

## Information

### Transmitted MMRP PDU

Displays the number of MMRPDUs transmitted in the device.

### Received MMRP PDU

Displays the number of MMRPDUs received in the device.

### Received bad header PDU

Displays the number of MMRPDUs received with a bad header in the device.

### Received bad format PDU

Displays the number of MMRPDUs with a bad data field that were not transmitted in the device.

### Transmission failed

Displays the number of MMRPDUs not transmitted in the device.

## Table

### Port

Displays the port number.

### Transmitted MMRP PDU

Displays the number of MMRPDUs transmitted on the port.

### Received MMRP PDU

Displays the number of MMRPDUs received on the port.

### Received bad header PDU

Displays the number of MMRPDUs with a bad header that were received on the port.

### Received bad format PDU

Displays the number of MMRPDUs with a bad data field that were not transmitted on the port.

### Transmission failed

Displays the number of MMRPDUs not transmitted on the port.

### Last received MAC address

Displays the last MAC address from which the port received MMRPPDUs.

## Buttons

You find the description of the standard buttons in section [“Buttons” on page 14](#).

### Reset

Resets the port statistics counters and the values in the *Last received MAC address* column.

## 5.6.3 MRP-IEEE Multiple VLAN Registration Protocol

[Switching > MRP-IEEE > MVRP]

The Multiple VLAN Registration Protocol (MVRP) provides a mechanism that lets you distribute VLAN information and configure VLANs dynamically. For example, when you configure a VLAN on an active MVRP port, the device distributes the VLAN information to other MVRP enabled devices. Using the information received, an MVRP enabled device dynamically creates the VLAN trunks on other MVRP enabled devices as needed.

The dialog contains the following tabs:

- ▶ [\[Configuration\]](#)
- ▶ [\[Statistics\]](#)

### [Configuration]

In this tab you select active MVRP port participants and set the device to transmit periodic events.

A periodic state machine exists for each port and transmits periodic events regularly to the applicant state machines associated with active ports. Periodic events contain information indicating the status of the VLANs associated with the active port. Using the periodic events, MVRP enabled switches dynamically maintain the VLANs.

### Operation

#### Operation

Enables/disables the global Applicant Administrative Control which specifies if the Applicant state machine participates in MMRP message exchanges.

Possible values:

- ▶ *On*  
Normal Participant. The Applicant state machine participates in MMRP message exchanges.
- ▶ *Off* (default setting)  
Non-Participant. The Applicant state machine ignores MMRP messages.

## Configuration

### Periodic state machine

Enables/disables the periodic state machine in the device.

Possible values:

- ▶ *On*  
 The periodic state machine is enabled.  
 With MVRP *Operation* enabled globally, the device transmits MVRP periodic events in 1 second intervals, on MVRP participating ports.
- ▶ *Off* (default setting)  
 The periodic state machine is disabled.  
 Disables the periodic state machine in the device.

## Table

### Port

Displays the port number.

### Active

Activates/deactivates the port MVRP participation.

Possible values:

- ▶ *marked* (default setting)  
 With MVRP enabled globally and on this port, the device distributes VLAN membership information to MVRP-aware devices connected to this port.
- ▶ *unmarked*  
 Disables the port MVRP participation.

### Restricted VLAN registration

Activates/deactivates the *Restricted VLAN registration* function on this port.

Possible values:

- ▶ *marked*  
 If enabled and a static VLAN registration entry exists, then the device lets you create a dynamic VLAN for this entry.
- ▶ *unmarked* (default setting)  
 Disables the *Restricted VLAN registration* function on this port.

## Buttons

You find the description of the standard buttons in section [“Buttons” on page 14](#).



## [Statistics]

Devices on a LAN exchange Multiple VLAN Registration Protocol Data Units (MVRPDU) to maintain statuses of VLANs on active ports. This tab lets you monitor the MVRP traffic.

### Information

#### Transmitted MVRP PDU

Displays the number of MVRPDUs transmitted in the device.

#### Received MVRP PDU

Displays the number of MVRPDUs received in the device.

#### Received bad header PDU

Displays the number of MVRPDUs received with a bad header in the device.

#### Received bad format PDU

Displays the number of MVRPDUs with a bad data field that the device blocked.

#### Transmission failed

Displays the number of failures while adding a message into the MVRP queue.

#### Message queue failures

Displays the number of MVRPDUs that the device blocked.

### Table

#### Port

Displays the port number.

#### Transmitted MVRP PDU

Displays the number of MVRPDUs transmitted on the port.

#### Received MVRP PDU

Displays the number of MVRPDUs received on the port.

#### Received bad header PDU

Displays the number of MVRPDUs with a bad header that the device received on the port.

#### Received bad format PDU

Displays the number of MVRPDUs with a bad data field that the device blocked on the port.

## Transmission failed

Displays the number of MVRPDUs that the device blocked on the port.

## Registrations failed

Displays the number of failed registration attempts on the port.

## Last received MAC address

Displays the last MAC address from which the port received MMRPDUs.

**Buttons**

You find the description of the standard buttons in section “Buttons” on page 14.

## Reset

Resets the port statistics counters and the values in the *Last received MAC address* column.

## 5.7 QoS/Priority

[Switching > QoS/Priority]

Communication networks transmit a number of applications at the same time that have different requirements as regards availability, bandwidth and latency periods.

QoS (Quality of Service) is a procedure defined in IEEE 802.1D. It is used to distribute resources in the network. You therefore have the possibility of providing minimum bandwidth for necessary applications. The prerequisite is that the end devices and the devices in the network support prioritized data transmission. Data packets with high priority are given preference when transmitted by devices in the network. You transfer data packets with lower priority when there are no data packets with a higher priority to be transmitted.

The device provides the following setting options:

- ▶ You specify how the device evaluates QoS/prioritization information for inbound data packets.
- ▶ For outbound packets, you specify which QoS/prioritization information the device writes in the data packet (for example priority for management packets, port priority).

**Note:** If you use the functions in this menu, then disable the flow control. The flow control is inactive if in the *Switching > Global* dialog, *Configuration* frame the *Flow control* checkbox is *unmarked*.

The menu contains the following dialogs:

- ▶ [QoS/Priority Global](#)
- ▶ [QoS/Priority Port Configuration](#)
- ▶ [802.1D/p Mapping](#)
- ▶ [IP DSCP Mapping](#)
- ▶ [Queue Management](#)

## 5.7.1 QoS/Priority Global

[Switching > QoS/Priority > Global]

The device lets you maintain access to the device management, even in situations with heavy utilization. In this dialog you specify the required QoS/priority settings.

### Configuration

#### VLAN priority for management packets

Specifies the VLAN priority for sending management data packets. Depending on the VLAN priority, the device assigns the data packet to a specific traffic class and thus to a specific priority queue of the port.

Possible values:

▶ 0..7 (default setting: 0)

In the [Switching > QoS/Priority > 802.1D/p Mapping](#) dialog, you assign a traffic class to every VLAN priority.

#### IP DSCP value for management packets

Specifies the IP DSCP value for sending management data packets. Depending on the IP DSCP value, the device assigns the data packet to a specific traffic class and thus to a specific priority queue of the port.

Possible values:

▶ 0 (be/cs0) .. 63 (default setting: 0 (be/cs0))

Some values in the list also have a DSCP keyword, for example 0 (be/cs0), 10 (af11) and 46 (ef). These values are compatible with the IP precedence model.

In the [Switching > QoS/Priority > IP DSCP Mapping](#) dialog you assign a traffic class to every IP DSCP value.

#### Queues per port

Displays the number of priority queues per port.

The device has 8 priority queues per port. You assign every priority queue to a specific traffic class (traffic class according to IEEE 802.1D).

### Buttons

You find the description of the standard buttons in section [“Buttons” on page 14](#).

## 5.7.2 QoS/Priority Port Configuration

[Switching > QoS/Priority > Port Configuration]

In this dialog you specify for every port how the device processes received data packets based on their QoS/priority information.

### Table

Port

Displays the port number.

Port priority

Specifies what VLAN priority information the device writes into a data packet if the data packet contains no priority information. After this, the device transmits the data packet depending on the value specified in the *Trust mode* column.

Possible values:

- ▶ 0..7 (default setting: 0)

Trust mode

Specifies how the device handles a received data packet if the data packet contains QoS/priority information.

Possible values:

- ▶ *untrusted*  
The device transmits the data packet according to the priority specified in the *Port priority* column. The device ignores the priority information contained in the data packet.  
In the *Switching > QoS/Priority > 802.1D/p Mapping* dialog, you assign a traffic class to every VLAN priority.
- ▶ *trustDot1p* (default setting)  
The device transmits the data packet according to the priority information in the VLAN tag.  
In the *Switching > QoS/Priority > 802.1D/p Mapping* dialog, you assign a traffic class to every VLAN priority.
- ▶ *trustIpDscp*
  - If the data packet is an IP packet, then:  
The device transmits the data packet according to the IP DSCP value contained in the data packet.  
In the *Switching > QoS/Priority > IP DSCP Mapping* dialog you assign a traffic class to every IP DSCP value.
  - If the data packet is not an IP packet, then:  
The device transmits the data packet according to the priority specified in the *Port priority* column.  
In the *Switching > QoS/Priority > 802.1D/p Mapping* dialog, you assign a traffic class to every VLAN priority.

### Untrusted traffic class

Displays the traffic class assigned to the VLAN priority information specified in the *Port priority* column. In the *Switching > QoS/Priority > 802.1D/p Mapping* dialog, you assign a traffic class to every VLAN priority.

Possible values:

▶ 0..7

### Buttons

You find the description of the standard buttons in section “Buttons” on page 14.

## 5.7.3 802.1D/p Mapping

[Switching > QoS/Priority > 802.1D/p Mapping]

The device transmits data packets with a VLAN tag according to the contained QoS/priority information with a higher or lower priority.

In this dialog you assign a traffic class to every VLAN priority. You assign the traffic classes to the priority queues of the ports.

### Table

VLAN priority

Displays the VLAN priority.

Traffic class

Specifies the traffic class assigned to the VLAN priority.

Possible values:

▶ 0..7

0 assigned to the priority queue with the lowest priority.

7 assigned to the priority queue with the highest priority.

**Note:** Among other things redundancy mechanisms use the highest traffic class. Therefore, select another traffic class for application data.

### Buttons

You find the description of the standard buttons in section [“Buttons” on page 14](#).

### Default assignment of the VLAN priority to traffic classes

VLAN Priority	Traffic class	Content description according to IEEE 802.1D
0	2	Best Effort Normal data without prioritizing
1	0	Background Non-time-sensitive data and background services
2	1	Standard Normal data
3	3	Excellent Effort Crucial data
4	4	Controlled Load Time-sensitive data with a high priority

VLAN Priority	Traffic class	Content description according to IEEE 802.1D
5	5	Video Video transmission with delays and jitter < 100 ms
6	6	Voice Voice transmission with delays and jitter < 10 ms
7	7	Network Control Data for network management and redundancy mechanisms

## 5.7.4 IP DSCP Mapping

[Switching > QoS/Priority > IP DSCP Mapping]

The device transmits IP data packets according to the DSCP value contained in the data packet with a higher or lower priority.

In this dialog you assign a traffic class to every DSCP value. You assign the traffic classes to the priority queues of the ports.

### Table

DSCP value

Displays the DSCP value.

Traffic class

Specifies the traffic class which is assigned to the DSCP value.

Possible values:

▶ 0..7

0 assigned to the priority queue with the lowest priority.

7 assigned to the priority queue with the highest priority.

### Buttons

You find the description of the standard buttons in section [“Buttons” on page 14](#).

### Default assignment of the DSCP values to traffic classes

DSCP Value	DSCP Name	Traffic class
0	Best Effort /CS0	2
1-7		2
8	CS1	0
9,11,13,15		0
10,12,14	AF11,AF12,AF13	0
16	CS2	1
17,19,21,23		1
18,20,22	AF21,AF22,AF23	1
24	CS3	3
25,27,29,31		3
26,28,30	AF31,AF32,AF33	3
32	CS4	4
33,35,37,39		4
34,36,38	AF41,AF42,AF43	4



## Switching

[Switching > QoS/Priority > IP DSCP Mapping]

---

DSCP Value	DSCP Name	Traffic class
40	CS5	5
41,42,43,44,45,47		5
46	EF	5
48	CS6	6
49-55		6
56	CS7	7
57-63		7

## 5.7.5 Queue Management

[ Switching > QoS/Priority > Queue Management ]

This dialog lets you enable and disable the *Strict priority* function for the traffic classes. When you disable the *Strict priority* function, the device processes the priority queues of the ports with "Weighted Fair Queuing".

You also have the option of assigning a minimum bandwidths to every traffic classes which the device uses to process the priority queues with "Weighted Fair Queuing"

### Table

Traffic class

Displays the traffic class.

Strict priority

Activates/deactivates the processing of the port priority queue with *Strict priority* for this traffic class.

Possible values:

▶ *marked* (default setting)

The processing of the port priority queue with *Strict priority* is active.

- The port forwards only data packets that are in the priority queue with the highest priority. When this priority queue is empty, the port forwards data packets that are in the priority queue with the next lower priority.
- The port forwards data packets with a lower traffic class after the priority queues with a higher priority are empty. In unfavorable situations, the port does not send these data packets.
- When you select this setting for a traffic class, the device also enables the function for traffic classes with a higher priority.
- Use this setting for applications such as VoIP or video that require the least possible delay.

▶ *unmarked*

The processing of the port priority queue with *Strict priority* is inactive. The device uses "Weighted Fair Queuing"/"Weighted Round Robin" (WRR) to process the port priority queue.

- The device assigns a minimum bandwidth to each traffic class.
- Even under a high network load the port transmits data packets with a low traffic class.
- When you select this setting for a traffic class, the device also disables the function for traffic classes with a lower priority.

Min. bandwidth [%]

Specifies the minimum bandwidth for this traffic class when the device is processing the priority queues of the ports with "Weighted Fair Queuing".

Possible values:

▶ *0..100* (default setting: 0 = the device does not reserve any bandwidth for this traffic class)

The value specified in percent refers to the available bandwidth on the port. When you disable the *Strict priority* function for every traffic class, the maximum bandwidth is available on the port for the "Weighted Fair Queuing".

The maximum total of the assigned bandwidths is 100 %.

Max. bandwidth [%]

Specifies the shaping rate at which a Traffic Class transmits packets (Queue Shaping).

Possible values:

- ▶ 0 (default setting)  
The device does not reserve any bandwidth for this traffic class.
- ▶ 1..100  
The device reserves the specified bandwidth for this traffic class. The specified value in percent refers to the maximum available bandwidth on this port.

For example, using queue shaping lets you limit the rate of a strict-high priority queue. Limiting a strict-high priority queue lets the device also process low-priority queues. To use queue shaping, you set the maximum bandwidth for a particular queue.

## Buttons

You find the description of the standard buttons in section [“Buttons” on page 14](#).

## 5.8 VLAN

[Switching > VLAN]

With VLAN (Virtual Local Area Network) you distribute the data traffic in the physical network to logical subnetworks. This provides you with the following advantages:

- ▶ High flexibility
  - With VLAN you distribute the data traffic to logical networks in the existing infrastructure. Without VLAN, it would be necessary to have additional devices and complicated cabling.
  - With VLAN you specify network segments independently of the location of the individual end devices.
- ▶ Improved throughput
  - In VLANs data packets can be transferred by priority. When the priority is high, the device transfers the data of a VLAN preferentially, for example for time-sensitive applications such as VoIP phone calls.
  - When the data packets and Broadcasts are distributed in small network segments instead of in the entire network, the network load is considerably reduced.
- ▶ Increased security  
The distribution of the data traffic among individual logical networks makes unwanted accessing more difficult and strengthens the system against attacks such as MAC Flooding or MAC Spoofing.

The device supports packet-based “tagged” VLANs according to the IEEE 802.1Q standard. The VLAN tagging in the data packet indicates the VLAN to which the data packet belongs.

The device transmits the tagged data packets of a VLAN only on ports that are assigned to the same VLAN. This reduces the network load.

The device learns the MAC addresses for every VLAN separately (independent VLAN learning).

The device prioritizes the received data stream in the following sequence:

- ▶ Voice VLAN
- ▶ Port-based VLAN

The menu contains the following dialogs:

- ▶ VLAN Global
- ▶ VLAN Configuration
- ▶ VLAN Port
- ▶ VLAN Voice

## 5.8.1 VLAN Global

[Switching > VLAN > Global]

This dialog lets you view general VLAN parameters for the device.

### Configuration

Max. VLAN ID

Highest ID assignable to a VLAN.

See the [Switching > VLAN > Configuration](#) dialog.

VLANs (max.)

Displays the maximum number of VLANs possible.

See the [Switching > VLAN > Configuration](#) dialog.

VLANs

Number of VLANs currently configured in the device.

See the [Switching > VLAN > Configuration](#) dialog.

The VLAN ID 1 is constantly present in the device.

### Buttons

You find the description of the standard buttons in section [“Buttons” on page 14](#).

Clear...

Resets the VLAN settings of the device to the default setting.

Note that you lose your connection to the device if you have changed the VLAN ID for the device management in the [Basic Settings > Network](#) dialog.

## 5.8.2 VLAN Configuration

[ Switching > VLAN > Configuration ]

In this dialog you manage the VLANs. To set up a VLAN, create a further row in the table. There you specify for each port if it transmits data packets of the respective VLAN and if the data packets contain a VLAN tag.

You distinguish between the following VLANs:

- ▶ The user sets up static VLANs.
- ▶ The device sets up dynamic VLANs automatically and removes them if the prerequisites cease to apply.

For the following functions the device creates dynamic VLANs:

- *MRP*: If you assign to the ring ports a non-existing VLAN, then the device creates this VLAN.
- *MVRP*: The device creates a VLAN based on the messages of neighboring devices.

**Note:** The settings are effective only if the VLAN Unaware Mode is disabled. See the [Switching > Global](#) dialog.

### Table

VLAN ID

ID of the VLAN.

The device supports up to 256 VLANs simultaneously set up.

Possible values:

- ▶ 1..4042

Status

Displays how the VLAN is set up.

Possible values:

- ▶ *other*  
VLAN 1  
or  
VLAN set up using the [802.1X Port Authentication](#) function. See the [Network Security > 802.1X Port Authentication](#) dialog.
- ▶ *permanent*  
VLAN set up by the user.  
or  
VLAN set up using the *MRP* function. See the [Switching > L2-Redundancy > MRP](#) dialog.  
If you save the changes in the non-volatile memory, then the VLANs with this setting remain set up after a restart.
- ▶ *dynamicMvrp*  
VLAN set up using the *MVRP* function. See the [Switching > MRP-IEEE > MVRP](#) dialog.  
VLANs with this setting are write-protected. The device removes a VLAN from the table as soon as the last port leaves the VLAN.

## Creation time

Displays the time of VLAN creation.

The field displays the time stamp for the operating time (system uptime).

## Name

Specifies the name of the VLAN.

Possible values:

- ▶ Alphanumeric ASCII character string with 1..32 characters

## &lt;Port number&gt;

Specifies if the respective port transmits data packets of the VLAN and if the data packets contain a VLAN tag.

Possible values:

- ▶ - (default setting)  
The port is not a member of the VLAN and does not transmit data packets of the VLAN.
- ▶ T = Tagged  
The port is a member of the VLAN and transmits the data packets with a VLAN tag. You use this setting for uplink ports, for example.
- ▶ LT = Tagged Learned  
The port is a member of the VLAN and transmits the data packets with a VLAN tag.  
The device created the entry automatically based on the *GVRP* or *MVRP* function.
- ▶ F = Forbidden  
The port is not a member of the VLAN and does not transmit data packets of this VLAN.  
Additionally, the device helps prevent the port from becoming a VLAN member through the *MVRP* function.
- ▶ U = Untagged (default setting for VLAN 1)  
The port is a member of the VLAN and transmits the data packets without a VLAN tag. Use this setting if the connected device does not evaluate any VLAN tags, for example on end ports.
- ▶ LU = Untagged Learned  
The port is a member of the VLAN and transmits the data packets without a VLAN tag.  
The device created the entry automatically based on the *GVRP* or *MVRP* function.

**Note:** Verify that the port on which the network management station is connected is a member of the VLAN in which the device transmits the management data. In the default setting, the device transmits the management data on VLAN 1. Otherwise, the connection to the device terminates when you transfer the changes to the device. The access to the device management is possible only using the Command Line Interface through the serial interface.

**Buttons**

You find the description of the standard buttons in section “Buttons” on page 14.



Opens the *Create* window to add a new entry to the table.

In the *VLAN ID* field, you specify the ID of the VLAN.

## 5.8.3 VLAN Port

[Switching > VLAN > Port]

In this dialog you specify how the device handles received data packets that have no VLAN tag, or whose VLAN tag differs from the VLAN ID of the port.

This dialog lets you assign a VLAN to the ports and thus specify the port VLAN ID.

Additionally, you also specify for each port how the device transmits data packets if the VLAN Unaware mode is disabled and one of the following situations occurs:

- ▶ The port receives data packets without a VLAN tagging.
- ▶ The port receives data packets with VLAN priority information (VLAN ID 0, priority tagged).
- ▶ The VLAN tagging of the data packet differs from the VLAN ID of the port.

**Note:** The settings are effective only if the VLAN Unaware Mode is disabled. See the [Switching > Global](#) dialog.

### Table

Port

Displays the port number.

Port-VLAN ID

Specifies the ID of the VLAN which the device assigns to data packets without a VLAN tag.

Prerequisites:

- In the *Acceptable packet types* column, you specify the value `admitAll`.

Possible values:

- ▶ ID of a VLAN you set up (default setting: 1)

If you use the *MRP* function and you did not assign a VLAN to the ring ports, then you specify the value 1 here for the ring ports. Otherwise, the device assigns the value to the ring ports automatically.

Acceptable packet types

Specifies if the port transmits or discards received data packets without a VLAN tag.

Possible values:

- ▶ `admitAll` (default setting)  
The port accepts data packets both with and without a VLAN tag.
- ▶ `admitOnlyVlanTagged`  
The port accepts only data packets tagged with a VLAN ID  $\geq 1$ .



### Ingress filtering

Activates/deactivates the ingress filtering.

Possible values:

▶ `marked`

The ingress filtering is active.

The device compares the VLAN ID in the data packet with the VLANs of which the device is a member. See the [Switching > VLAN > Configuration](#) dialog. If the VLAN ID in the data packet matches one of these VLANs, then the port transmits the data packet. Otherwise, the device discards the data packet.

▶ `unmarked` (default setting)

The ingress filtering is inactive.

The device transmits received data packets without comparing the VLAN ID. Thus the port also transmits data packets with a VLAN ID of which the port is not a member.

### Buttons

You find the description of the standard buttons in section [“Buttons” on page 14](#).

## 5.8.4 VLAN Voice

[ Switching > VLAN > Voice ]

Use the Voice VLAN feature to separate voice and data traffic on a port, by VLAN and/or priority. A primary benefit of Voice VLAN is safeguarding the quality of voice traffic when data traffic on the port is high.

The device detects VoIP phones using the Link Layer Discovery Protocol - Media Endpoint Discovery (LLDP-MED). The device then adds the appropriate port to the member set of the configured Voice VLAN. The member set is either tagged or untagged. Tagging depends on the Voice VLAN interface mode (VLAN ID, Dot1p, None, Untagged).

Another benefit of the Voice VLAN feature is that the VoIP phone obtains VLAN ID or priority information via LLDP-MED from the device. As a result, the VoIP phone sends voice data tagged as priority, or untagged. This depends on the configured Voice VLAN Interface mode. You activate Voice VLAN on the port which is connecting to the VoIP phone.

### Operation

Operation

Enables/disables the *VLAN Voice* function of the device globally.

Possible values:

- ▶ *On*
- ▶ *Off* (default setting)

### Table

Port

Displays the port number.

Voice VLAN mode

Specifies if the port transmits or discards received data packets without voice VLAN tagging or with voice VLAN priority information.

Possible values:

- ▶ *disabled* (default setting)  
Deactivates the *VLAN Voice* function for this table entry.
- ▶ *none*  
Lets the IP telephone use its own configuration for sending untagged voice traffic.
- ▶ *vlan/dot1p-priority*  
The port filters data packets of the voice VLAN using the vlan and dot1p priority tags.
- ▶ *untagged*  
The port filters data packets without a voice VLAN tag.

▶ *vlan*

The port filters data packets of the voice VLAN using the vlan tag.

▶ *dot1p-priority*

The port filters data packets of the voice VLAN using the dot1p priority tags. If you select this value, then additionally specify a proper value in the *Priority* column.

### Data priority mode

Specifies the trust mode for the data traffic on the particular port.

The device uses this mode for data traffic on the voice VLAN, when it detects a VoIP telephone and a PC and when these devices use the same cable for transmitting and receiving data.

Possible values:

▶ *trust* (default setting)

If voice traffic is present on the interface, then the data traffic uses the normal priority with this setting.

▶ *untrust*

If voice traffic is present and the *Voice VLAN mode* is set to *dot1p-priority*, then the data has the priority 0. If the interface only transmits data, then the data has the normal priority.

### Status

Displays the status of the Voice VLAN on the port.

Possible values:

▶ *marked*

The Voice VLAN is enabled.

▶ *unmarked*

The Voice VLAN is disabled.

### VLAN ID

Specifies the ID of the VLAN to which the table entry applies.

To forward traffic to this VLAN ID using this filter, select in the *Voice VLAN mode* column the value *vlan*.

Possible values:

▶ 0..4042

### Priority

Specifies the Voice VLAN Priority of the port.

Prerequisites:

- In the *Voice VLAN mode* column, you specify the value *dot1p-priority*.

Possible values:

▶ 0..7

▶ *none*

Deactivates the Voice VLAN Priority of the port.

## Bypass authentication

Activates the Voice VLAN Authentication mode.

If you deactivate the function and set the value in the *Voice VLAN mode* column to *dot1p-priority*, then voice devices require an authentication.

Possible values:

- ▶ *marked* (default setting)  
If you activated the function in the *Network Security > 802.1X Port Authentication > Global* dialog, then set the *Port control* parameter for this port to the *multiClient* value before activating this function. You find the *Port control* parameter in the *Network Security > 802.1X Port Authentication > Global* dialog.
- ▶ *unmarked*

## Buttons

You find the description of the standard buttons in section “Buttons” on page 14.

## 5.9 L2-Redundancy

[Switching > L2-Redundancy]

The menu contains the following dialogs:

- ▶ MRP
- ▶ DLR (depends on hardware)
- ▶ PRP (depends on hardware)
- ▶ HSR (depends on hardware)
- ▶ Spanning Tree
- ▶ Link Aggregation
- ▶ Link Backup

## 5.9.1 MRP

[Switching > L2-Redundancy > MRP]

The Media Redundancy Protocol (MRP) is a protocol that lets you set up high-availability, ring-shaped network structures. An MRP ring with Hirschmann devices is made up of up to 100 devices that support the MRP protocol according to IEC 62439.

If a section fails, then the ring structure of an MRP ring changes back into a line structure. The maximum recovery time can be configured.

The Ring Manager function of the device closes the ends of a backbone in a line structure to a redundant ring.

**Note:** *Spanning Tree* and Ring Redundancy have an effect on each other. Deactivate the *Spanning Tree* protocol for the ports connected to the MRP ring. See the *Switching > L2-Redundancy > Spanning Tree > Port* dialog.

When you work with oversized Ethernet packets (the value in the *MTU* column for the port is > 1518, see the *Basic Settings > Port* dialog), the switching time of the MRP ring reconfiguration depends on the following parameters:

- ▶ Bandwidth of the ring line
- ▶ Size of the Ethernet packets
- ▶ Number of devices in the ring

Set the recovery time sufficiently large to help avoid delays in the MRP packages due to latencies in the devices. You can find the formula for calculating the switching time in IEC 62439-2, section 9.5.

### Operation

#### Operation

Enables/disables the *MRP* function.

After you configured the parameters for the MRP ring, enable the function here.

Possible values:

- ▶ *On*  
The *MRP* function is enabled.  
After you configured the devices in the MRP ring, the redundancy is active.
- ▶ *Off* (default setting)  
The *MRP* function is disabled.

## Ring port 1/Ring port 2

### Port

Specifies the number of the port that is operating as a ring port.

Possible values:

- ▶ `<Port number>`  
Number of the ring port

**Note:** If the device uses the software supporting Fast MRP, then you cannot select a [Link Aggregation](#) port as a ring port.

### Operation

Displays the operating status of the ring port.

Possible values:

- ▶ `forwarding`  
The port is enabled, connection exists.
- ▶ `blocked`  
The port is blocked, connection exists.
- ▶ `disabled`  
The port is disabled.
- ▶ `not-connected`  
No connection exists.

### Fixed backup

Activates/deactivates the backup port function for the [Ring port 2](#).

**Note:** The switch over to the primary port can exceed the maximum ring recovery time.

Possible values:

- ▶ `marked`  
The [Ring port 2](#) backup function is active. When the ring is closed, the ring manager reverts back to the primary ring port.
- ▶ `unmarked` (default setting)  
The [Ring port 2](#) backup function is inactive. When the ring is closed, the ring manager continues to send data on the secondary ring port.

## Configuration

### Ring manager

Enables/disables the [Ring manager](#) function.

If there is one device at each end of the line, then you activate this function.

Possible values:

- ▶ *On*  
The *Ring manager* function is enabled.  
The device operates as a ring manager.
- ▶ *Off* (default setting)  
The *Ring manager* function is disabled.  
The device operates as a ring client.

### Advanced mode

Activates/deactivates the advanced mode for fast recovery times.

Possible values:

- ▶ *marked* (default setting)  
Advanced mode active.  
MRP-capable Hirschmann devices support this mode.
- ▶ *unmarked*  
Advanced mode inactive.  
Select this setting if another device in the ring does not support this mode.

### Ring recovery

Specifies the maximum recovery time in milliseconds for reconfiguration of the ring. This setting is effective if the device operates as a ring manager.

Possible values:

- ▶ *500ms*
- ▶ *200ms* (default setting)
- ▶ *30ms* (depends on hardware)
- ▶ *10ms* (depends on hardware)

Shorter switching times make greater demands on the response time of every individual device in the ring. Use values lower than *500ms* if the other devices in the ring also support this shorter recovery time.

**Note:** The switching times *30ms* and *10ms* are available for devices with an FPGA (hardware for extended functions). The product code indicates if your device supports Fast MRP. In order to use the functions, load the device software supporting Fast MRP.

Set the switching time to *10ms* only if you use up to 20 devices in the ring that support this switching time. If you use more than 20 of these devices, then set the switching time to at least *30ms*.

When you are working with oversized Ethernet packets, the number of devices in the ring is limited. Note that the switching time depends on several parameters. See the description above.

## VLAN ID

Specifies the ID of the VLAN which you assign to the ring ports.

Possible values:

- ▶ 0 (default setting)  
 No VLAN assigned.  
 Assign in the [Switching > VLAN > Configuration](#) dialog to the ring ports for VLAN 1 the value `U`.
- ▶ 1..4042  
 VLAN assigned.  
 If you assign to the ring ports a non-existing VLAN, then the device creates this VLAN. In the [Switching > VLAN > Configuration](#) dialog, the device creates an entry in the table for the VLAN and assigns the value `T` to the ring ports.

## Information

### Information

Displays messages for the redundancy configuration and the possible causes of errors.

When the device operates as a ring client or a ring manager, the following messages are possible:

- ▶ *Redundancy available*  
 The redundancy is set up. When a component of the ring is down, the redundant line takes over its function.
- ▶ *Configuration error: Error on ringport link.*  
 Error in the cabling of the ring ports.

When the device operates as a ring manager, the following messages are possible:

- ▶ *Configuration error: Packets from another ring manager received.*  
 Another device exists in the ring that operates as the ring manager.  
 Enable the *Ring manager* function only on one device in the ring.
- ▶ *Configuration error: Ring link is connected to wrong port.*  
 A line in the ring is connected with a different port instead of with a ring port. The device only receives test data packets on one ring port.

## Buttons

You find the description of the standard buttons in section [“Buttons” on page 14](#).

### Delete ring configuration

Disables the redundancy function and resets the settings in the dialog to the default setting.



## 5.9.2 DLR (depends on hardware)

[Switching > L2-Redundancy > DLR]

The Device Level Ring (DLR) protocol provides high network availability in a ring topology. The primary intent for the DLR protocol is implementation in EtherNet/IP end-devices that have 2 Ethernet ports and embedded Layer 2 switch technology. The DLR protocol provides network fault detection and reconfiguration to support demanding control applications.

The DLR network uses a ring supervisor to monitor the network. The ring supervisor controls data on the ring by sending data only on the primary ring port until a break in the ring occurs. When a break in the ring occurs, the ring supervisor unblocks the secondary port allowing the data to reach the ring participants located on the other side of the break.

To maintain control of the network, the active ring supervisor sends Beacon packets through both ports. The device lets you specify the interval between consecutive Beacon packets. The Beacon packets help detect breaks in the ring, send Ring State messages to the participants, and also contain the following information:

- ▶ the precedence of the active ring supervisor
- ▶ the MAC address of the active ring supervisor
- ▶ the Beacon timeout
- ▶ the DLR VLAN ID

In the supervisor mode, the device also sends Announce packets, once every second, through the unblocked port only. The Announce packets also contain Ring State messages.

In the non-supervisor mode, the device functions as a Beacon-based participant. Upon receiving a Ring Fault State message from the active ring supervisor, the Beacon-based participant flushes its unicast MAC address table, and conducts a Neighbor Check. The Neighbor Check helps isolate a break between adjacent participants.

DLR uses a VLAN to distribute information contained in the Beacon Packet, to other ring participants as priority tagged. The default setting for the DLR VLAN ID is 0. VLAN ID is 0 is only set in this dialog. You use VLAN ID 0 in conjunction with the [VLAN unaware mode](#).

Verify that the functions which directly affect the [DLR](#) function have the following settings:

<a href="#">EtherNet/IP</a>	<a href="#">Advanced &gt; Industrial Protocols &gt; EtherNet/IP</a> dialog <ul style="list-style-type: none"> <li>• <a href="#">Operation=On</a></li> <li>• <a href="#">Write access=marked</a></li> </ul>
<a href="#">Spanning Tree</a>	<a href="#">Switching &gt; L2-Redundancy &gt; Spanning Tree &gt; Global</a> dialog <ul style="list-style-type: none"> <li>• <a href="#">Operation=Off</a></li> </ul>
<a href="#">VLAN</a>	<a href="#">Switching &gt; Global</a> dialog <ul style="list-style-type: none"> <li>• <a href="#">VLAN unaware mode=marked</a></li> </ul>
<a href="#">IGMP Snooping</a>	<a href="#">Switching &gt; IGMP Snooping &gt; Global</a> dialog <ul style="list-style-type: none"> <li>• <a href="#">Operation = On</a></li> </ul> <a href="#">Switching &gt; IGMP Snooping &gt; Configuration</a> dialog, <a href="#">Port</a> tab <ul style="list-style-type: none"> <li>• <a href="#">Active = marked</a></li> </ul> <a href="#">Switching &gt; IGMP Snooping &gt; Snooping Enhancements</a> dialog <ul style="list-style-type: none"> <li>• <a href="#">DLR ring ports = SF (Static and Forward all)</a></li> </ul> <a href="#">Switching &gt; IGMP Snooping &gt; Querier</a> dialog <ul style="list-style-type: none"> <li>• <a href="#">Operation=On</a></li> </ul>

**Note:** [DLR](#) is available for devices with an FPGA (hardware for extended functions). The product code indicates if your device supports [DLR](#). In order to use the functions, load the device software supporting [DLR](#).

The menu contains the following dialogs:

- ▶ DLR Configuration (depends on hardware)
- ▶ DLR Statistics (depends on hardware)

## 5.9.2.1 DLR Configuration (depends on hardware)

[Switching > L2-Redundancy > DLR > Configuration]

In this dialog you specify the role of the device in the ring. When you specify the device as a ring supervisor, the device sends Beacon packets containing its precedence for active ring supervisor candidacy. As active ring supervisor, the device monitors the ring for breaks, and sends configuration information to the ring participants.

### Operation

Operation

Enables/disables the *DLR* function globally.

Possible values:

- ▶ *On* (default setting)  
The *DLR* function is enabled.
- ▶ *Off*  
The *DLR* function is disabled.

### Table

Ring index

Displays the index number to which the table entry relates.

Name

Specifies the name of the DLR ring.

Possible values:

- ▶ Alphanumeric ASCII character string with 0..255 characters

Ring port 1

Specifies the first of 2 ring ports used to connect the device to the DLR ring.

Possible values:

- ▶ `<Port number>` (default setting: 1/1)  
In the drop-down list, select the port.

Ring port 1 status

Displays the status of ring port 1.

Possible values:

- ▶ *disabled*  
The port is disabled.  
To enable the port, open the *Basic Settings > Port* dialog, *Configuration* tab. In the *Port on* column, mark the appropriate checkbox.

- ▶ *blocked*  
The port is the secondary port, sending and receiving only Beacon packets.
- ▶ *forwarding*  
The port is the primary port, sending and receiving data, Beacon packets, and Announce packets.
- ▶ *notConnected*  
The port is physically unconnected.

#### Ring port 2

Specifies the second of 2 ring ports used to connect the device to the DLR ring.

Possible values:

- ▶ *<Port number>* (default setting: 1/2)  
In the drop-down list, select the port.

#### Ring port 2 status

Displays the status of ring port 2.

Possible values:

- ▶ *disabled*  
The port is disabled.  
To enable the port, open the [Basic Settings > Port](#) dialog, [Configuration](#) tab. In the [Port on](#) column, mark the appropriate checkbox.
- ▶ *blocked*  
The port is the secondary port, sending and receiving only Beacon packets.
- ▶ *forwarding*  
The port is the primary port, sending and receiving data, Beacon packets, and Announce packets.
- ▶ *notConnected*  
The port is physically unconnected.

#### Supervisor active

Activates/deactivates the supervisor function.

Possible values:

- ▶ *marked* (default setting)  
The device is configured as a ring supervisor. The device monitors the ring for breaks. If a break in the ring occurs, then the device unblocks and forwards data on the secondary port.
- ▶ *unmarked*  
The device is a Beacon-based ring participant.

#### Status

Displays the status of the device in the DLR ring.

Possible values:

- ▶ *backup*  
Another device in the same ring is the active supervisor.
- ▶ *supervisor*  
This device is the active supervisor.
- ▶ *node*  
The device functions as a Beacon-based ring participant.

- ▶ *nonDlr*  
The device has detected that the network topology is something other than a ring using the DLR protocol.
- ▶ *unsupported*  
The configuration in the row is invalid.

#### Supervisor precedence

Specifies the precedence value of the device for the ring supervisor selection. The device sends the value to other ring devices in the Beacon packets. When another ring supervisor is present on the same ring, the device with the higher value is selected active ring supervisor. When both values are the same, the device with the higher MAC address becomes active supervisor.

Possible values:

- ▶ 0..255 (default setting: 0)  
A numerically higher value indicates a higher precedence.

#### Beacon interval [μs]

Specifies the interval, in microseconds, at which the supervisor sends Beacon packets. The ring supervisor transmits a Beacon packet through both of its Ethernet ports once per Beacon interval. When the ring is intact, the device receives the Beacon packet on the opposite ports, and leaves the blocked port in the blocking mode.

Possible values:

- ▶ 400..100000 (default setting: 400)  
Lower interval times increase the recovery time. When the ring contains only DLR participants, use the following formula to calculate:  
`Minimum value = 13 * Number of ring participants`

#### Beacon timeout [μs]

Specifies the amount of time, in microseconds, the device listens for Beacon packets. After the device times out the reception of a Beacon packet, it takes the appropriate action depending on its role as an active supervisor or ring participant.

Possible values:

- ▶ 1600..500000 (default setting: 1960)  
Set this value to at least 4 times the value specified in the *Beacon interval [μs]* column.  
When the ring contains only DLR participants, use the following formula to calculate:  
`Maximum value = (Number of ring participants * (1 - 0.1) * 25) + (Number of ring participants * 0.1 * 137)`

#### VLAN ID

Specifies the VLAN ID used to send the DLR protocol messages to the other devices on the ring.

The active supervisor informs the ring participants which VLAN ID to use in the Beacon packets. Create and configure the VLAN in the *Switching > VLAN > Configuration* dialog.

The prerequisite for setting the VLAN ID to 0 is that you activate the VLAN unaware mode. In the *Switching > Global* dialog, mark the *VLAN unaware mode* checkbox.

Possible values:

- ▶ 0..4042 (default setting: 0)

Active

Activates/deactivates the DLR configuration.

Possible values:

- ▶ `marked`  
The DLR configuration is active.
- ▶ `unmarked` (default setting)  
The DLR configuration is inactive.

## Buttons

You find the description of the standard buttons in section [“Buttons” on page 14](#).

Service action

Opens the [Service action](#) dialog to specify the DLR services that the device uses to help locate and clear detected faults.

Possible values:

- ▶ `verifyFaultLocation` (default setting)  
The supervisor verifies the fault location by retransmitting the `Locate_Fault` packet to ring participants.
- ▶ `clearRapidFaults`  
Clears the `Rapid Fault` condition where the ring supervisor detected a cycle of rapid ring faults.
- ▶ `restartSignOn`  
Restarts the `Sign On` process and refreshes the participants list.

## 5.9.2.2 DLR Statistics (depends on hardware)

[Switching > L2-Redundancy > DLR > Statistics]

This dialog displays the status of the ring, the type of topology, number of participants, and other information to help you to analyze the network.

This dialog also displays a list of participating ring participants. The active ring supervisor gathers the information contained in the participants list using the `Sign_On` packet. If the participants list is too large, then the DLR Object returns, `Reply Data Too Large` (code 0x11).

The dialog contains the following tabs:

- ▶ [Status]
- ▶ [Participants]

### [Status]

#### Table

Ring index

Displays the index number to which the table entry relates.

Capability

Displays the capabilities of the device.

Possible values:

- ▶ `announce`  
The device is an announce-based ring participant.
- ▶ `beacon`  
The device is capable of sending Beacon packets.
- ▶ `supervisor`  
The device is capable of being a supervisor.
- ▶ `gateway`  
The device is capable of being a gateway.
- ▶ `flushTable`  
The device is capable of flushing the unicast MAC address table.

Status

Displays the status of the device in the DLR ring.

Possible values:

- ▶ `backup`  
Another device in the same ring is the active supervisor.
- ▶ `supervisor`  
This device is the active supervisor.
- ▶ `node`  
The device functions as a Beacon-based ring participant.

- ▶ *nonDlr*  
The device has detected that the network topology is something other than a ring using the DLR protocol.
- ▶ *unsupported*  
The row parameters are invalid.

#### Network topology

Displays the current network topology mode.

Possible values:

- ▶ *linear*  
The network is linear.
- ▶ *ring*  
The network is a DLR ring.

#### Network status

Displays the current network status.

Possible values:

- ▶ *normal*  
After the device receives Beacon packets on both ports, the supervisor transitions to the NORMAL\_STATE, flushes the unicast MAC address table, and reconfigures a port to blocking. The device sends Beacon packets with the Ring State set to RING\_NORMAL\_STATE. The ring supervisor also sends an Announce packet out of the forwarding port, with the Ring State set to RING\_NORMAL\_STATE.
- ▶ *ringFault*  
The reasons for which the device displays the value are as follows:
  - Upon boot up, an enabled ring supervisor starts in the FAULT\_STATE with both ports forwarding packets.
  - The device received a Beacon packet from another supervisor with a higher precedence.
  - Upon receipt of a Beacon packet with the Ring State set to RING\_FAULT\_STATE.
 When the device is in the FAULT\_STATE, the ring supervisor continues to send Beacon packets, in order to detect ring restoration.
- ▶ *loop*  
The device has detected a loop in the network.
- ▶ *partial*  
The device detected a partial network fault where the Beacon packets are lost only in one direction. If the active ring supervisor detects a partial fault, then it blocks traffic on one port and sets a status value in the DLR Object. The condition requires user intervention.
- ▶ *rapidFault*  
The device detected a rapid fault, 5 faults in a 30 second period. Rapid faults can lead to an instable network. If the active ring supervisor detects a rapid fault, then it blocks traffic on one port and sets a status value in the DLR Object. The condition requires user intervention. To reset the device open the [Switching > L2-Redundancy > DLR > Configuration](#) dialog and set the value *clearRapidFaults* in the *Service* column.

#### Last status change

Displays the time, in seconds, since the network status last changed.

#### Participants

Displays the number of devices in the ring protocol participants list.



### Supervisor IP address

Displays the IPv4 address assigned to the active supervisor.

### Supervisor MAC address

Displays the MAC address of the active ring supervisor.

### Supervisor precedence

Displays the precedence value of the active ring supervisor.

### Faults

Displays the number of times that the device has detected a ring fault, since starting as either the active or the backup supervisor.

### Port 1 IP address

Displays the IPv4 address assigned to port 1.

### Port 1 MAC address

Displays the MAC address of last active ring participant on port 1.

### Port 2 IP address

Displays the IPv4 address assigned to port 2.

### Port 2 MAC address

Displays the MAC address of last active ring participant on port 2.

## Buttons

You find the description of the standard buttons in section [“Buttons” on page 14](#).

## [Participants]

Only the active ring supervisor displays the ring participants.

## Table

### Index

Displays the index number to which the table entry relates.

### Address

Displays the IP address of the participating ring participant.

MAC address

Displays the MAC address of the participating ring participant.

### Buttons

You find the description of the standard buttons in section “Buttons” on page 14.

## 5.9.3 PRP (depends on hardware)

[Switching > L2-Redundancy > PRP]

The Parallel Redundancy Protocol (PRP) is defined in the international standard IEC 62439-3. PRP uses 2 independent LANs with any ring, star, bus and mesh topologies, providing a high availability of network connections.

To connect the device to the PRP network, use either 100 Mbit/s FDX or 1000 Mbit/s FDX on both of the specially marked ports, *Port A* and *Port B*.

The maximum allowed size of Ethernet packets on these ports is restricted to 1534 bytes. See the *MTU* column in the *Basic Settings > Port* dialog.

The main advantage of PRP is that the destination node receives packets from the source as long as one LAN is available. The absence of the second LAN due to repairs or maintenance has no impact on the packet transmission.

The network device which connects the end devices to the network implements the PRP protocol. The Ethernet switches in both LANs are standard switches that are oblivious to PRP. A Double Attached Node implementing PRP (DANP) is a network device with PRP functionality and has one connection into each independent LAN. A Single Attached Node (SAN) is a standard Ethernet device with a single LAN interface directly connected to one of the redundant LANs. For this reason, a SAN is unable to use the redundant LAN.

A Redundancy Box (RedBox) is a network device which implements the PRP functionality for standard ethernet devices. A standard ethernet device when connected to a PRP network via a RedBox is a virtual DANP (VDAN).

**Note:** *PRP* is available for devices with an FPGA (hardware for extended functions). The product code indicates if your device supports *PRP*. In order to use the functions, load the device software supporting *PRP*.

**Note:** If the inter-frame gap is shorter than the latency between the 2 LANs, then a frame-ordering mismatch can occur. Frame-ordering mismatch is a phenomenon of the PRP protocol. The only solution to help avoid a frame-ordering mismatch is to verify that the inter-frame gap is greater than the latency between the LANs.

The menu contains the following dialogs:

- ▶ [PRP Configuration \(depends on hardware\)](#)
- ▶ [PRP DAN/VDAN Table \(depends on hardware\)](#)
- ▶ [PRP Proxy Node Table \(depends on hardware\)](#)
- ▶ [PRP Statistics \(depends on hardware\)](#)

### 5.9.3.1 PRP Configuration (depends on hardware)

[Switching > L2-Redundancy > PRP > Configuration]

In this dialog you enable/disable the *PRP* function, and configure PRP supervision packet reception and transmission.

The *MRP* and *Spanning Tree* functions cannot operate on the same ports as the *PRP* function. Disable the *MRP* function or choose different ports. Deactivate the *Spanning Tree* function on the PRP ports.

**Note:** When PRP is active, it uses the interfaces *1/1* and *1/2*. As seen in the *Switching > VLAN*, *Switching > Rate Limiter* and *Switching > Filter for MAC Addresses* dialogs, the *PRP* function replaces the interfaces *1/1* and *1/2* with the interface *prp/1*. Configure the VLAN membership, the rate limiting, and the MAC filtering for the interface *prp/1*.

#### Operation

##### Operation

Enables/disables the *PRP* function.

Possible values:

- ▶ *On*  
The *PRP* function is enabled globally.  
When this function is active, the device processes the data stream according to the set up.
- ▶ *Off* (default setting)  
The *PRP* function is disabled globally.  
To help avoid network loops, disable the *PRP* function on *Port A* or *Port B* before disabling the *PRP* function globally.

**Note:** When you use SFPs for PRP ports and the device only supports 100 Mbit/s, verify that the SFPs support 100 Mbit/s.

#### Port A / Port B

##### Physical port

Displays the number of the physical port which the device uses as the PRP *Port A* or *Port B*.

##### Port A admin state

Enables/disables the *PRP* function on the port.

Possible values:

- ▶ *On* (default setting)  
The *PRP* function on the port is enabled.  
Consider that the *802.1AS* function does not work properly on the port when you enable the *PRP* function.
- ▶ *Off*  
The *PRP* function on the port is disabled.

## Supervision packet receiver

### Evaluate supervision packets

Activates/deactivates the analysis of the supervision packets.

Possible values:

- ▶ `marked` (default setting)  
The analysis of the supervision packets is activated.  
The device receives Supervision Packets and analyzes them.
- ▶ `unmarked`  
The analysis of the supervision packets is deactivated.  
The device receives supervision packets without analyzing them.

## Supervision packet sender

### Active

Enables/disables the transmission of supervision packets.

Possible values:

- ▶ `On` (default setting)  
The transmission of supervision packets is enabled. The RedBox transmits its own supervision packets.
- ▶ `Off`  
The transmission of supervision packets is disabled.

### Send VDAN packets

Activates/deactivates the transmission of VDAN supervision packets.

The prerequisite is that you activate the [Supervision packet sender](#) first.

Possible values:

- ▶ `marked` (default setting)  
The transmission of VDAN supervision packets is active.  
The RedBox transmits both its own supervision packets and the supervision packets for the VDANs listed in the [PRP Proxy Node Table](#).
- ▶ `unmarked`  
The transmission of VDAN supervision packets is inactive.

## Configuration

### MTU

Specifies the maximum allowed size of Ethernet packets on the interface in bytes.

Possible values:

- ▶ `1518..1530` (default setting: `1518`)  
With the setting `1518`, the port transmits the Ethernet packets up to the following size:

- 1518 bytes without VLAN tag  
(1514 bytes + 4 bytes CRC)
- 1522 bytes with VLAN tag  
(1518 bytes + 4 bytes CRC)

This setting lets you increase the max. allowed size of Ethernet packets that this interface receives or transmits.

### Speed

Specifies the speed of the PRP interface. The prerequisite is that both PRP member ports operate with the specified speed.

Possible values:

- ▶ *100Mbps* (default setting)
- ▶ *1Gbps*

### Buttons

You find the description of the standard buttons in section [“Buttons” on page 14](#).

### 5.9.3.2 PRP DAN/VDAN Table (depends on hardware)

[Switching > L2-Redundancy > PRP > DAN/VDAN Table]

This dialog lets you analyze the LANs. This is helpful for example, when the *Last seen A* counter of one port continually increases while the *Last seen B* counter remains the same (and the other way round). This condition indicates an interruption of LAN connection.

DAN/VDAN means Double Attached Node / Virtual Double Attached Node.

#### Table

Index

Displays the index number to which the table entry relates.

MAC address

Displays the MAC address of the node.

Last seen A

Displays the time between received first packets for this node on LAN A. When the counter threshold reaches 497 days, it restarts from 0.

Last seen B

Displays the time between received first packets for this node on LAN B. When the counter threshold reaches 497 days, it restarts from 0.

Remote node type

Displays the type of node.

Possible values:

- ▶ *redboxp*  
Management
- ▶ *vdanp*  
Client

#### Buttons

You find the description of the standard buttons in section “Buttons” on page 14.

Reset

Resets the entire table.

### 5.9.3.3 PRP Proxy Node Table (depends on hardware)

[Switching > L2-Redundancy > PRP > Proxy Node Table]

This dialog informs you of the connected devices for which this device provides PRP redundancy.

**Note:** The Redbox supports up to 128 hosts. If this number is exceeded with Redbox, then the device drops the packets.

#### Table

##### Index

Displays the index number to which the table entry relates.

Possible values:

▶ 1..128

##### MAC address

Displays the MAC address of the connected devices for which this device implements PRP redundancy.

#### Buttons

You find the description of the standard buttons in section [“Buttons” on page 14](#).

##### Reset

Resets the entire table.

### 5.9.3.4 PRP Statistics (depends on hardware)

[ Switching > L2-Redundancy > PRP > Statistics ]

This dialog lists receive events for various MIB Managed Objects. Each entry represents link degradation for the MIB Managed Objects listed in the description column. The table lists how many times the event occurred for each path through the device. The Port A entries for example, specify the path between the transceiver, through the Link Redundancy Entity (LRE) to the UDP and TCP layers.

#### Table

Description

Displays the MIB Managed Objects description to which the *Port A*, *Port B*, and *Interlink* entries refer.

Port A

Displays the number of MIB Managed Objects events on *Port A*. The device examines the traffic as it passes from receive transceiver A to the LRE.

Port B

Displays the number of MIB Managed Objects events on *Port B*. The device examines the traffic as it passes from receive transceiver B to the LRE.

Interlink

Displays the number of MIB Managed Objects events on the interlink. The counters are active for the MIB Managed Objects that pertain to the interlink. The other counters remain empty. A sample is made of the traffic as it passes from the LRE to the switch.

CPU port

Displays the number of MIB Managed Objects events on the CPU Port. There is one MIB Managed Object that pertains to the CPU Port. The other counters remain empty. A sample is made of the traffic as it passes from receive transceiver to the CPU.

#### Buttons

You find the description of the standard buttons in section [“Buttons” on page 14](#).

Reset

Resets the entire table.



## 5.9.4 HSR (depends on hardware)

[Switching > L2-Redundancy > HSR]

An HSR-based ring offers zero recovery time (HSR = High-availability Seamless Redundancy). HSR is suited for applications that demand high availability and short reaction times. For example, protection applications for electrical station automation and controllers for synchronized drives which require constant connection.

HSR Redundancy Boxes (RedBox) use 2 Ethernet ports operating in parallel to connect to a ring. An HSR RedBox operating in this configuration is a Doubly Attached Node implementing the HSR protocol (DANH). A standard ethernet device connected to the HSR ring through an HSR RedBox is a Virtual DANH (VDANH).

The transmitting HSR node or HSR RedBox sends twin packets, one in each direction, on the ring. For identification, the HSR node injects the twin packets with an HSR tag. The HSR tag consists of a port identifier, the length of the payload and a sequence number. In a normal operating ring, the destination HSR node or RedBox receives both packets within a certain time skew. An HSR node forwards the first packet to arrive to the upper layers and discards the second packet when it arrives. A RedBox on the other hand forwards the first packet to the VDANHs and discards the second packet when it arrives.

The device performs a specific role in the network. Configure a device as an HSR RedBox connecting standard ethernet devices to an HSR ring. Configure a device as an HSR node connecting a PRP LAN to an HSR ring.

A single HSR ring accommodates up to 7 PRP LANs. Configure the device to identify and tag the traffic addressed for the connected PRP LAN.

The number of HSR nodes in the ring should not exceed 50. If the HSR interface speed is *1Gbps*, then the number should not exceed 300.

It is useful to limit the traffic injected into the HSR ring. If there are any third party devices with a higher latency in the ring, then you reduce the number of ring participants. Verify that the sum of bandwidths applied to the HSR nodes is less than 84 %.

**Note:** *HSR* is available for devices with an FPGA (hardware for extended functions). The product code indicates if your device supports *HSR*. In order to use the functions, load the device software supporting *HSR*.

The menu contains the following dialogs:

- ▶ [HSR Configuration \(depends on hardware\)](#)
- ▶ [HSR DAN/VDAN Table \(depends on hardware\)](#)
- ▶ [HSR Proxy Node Table \(depends on hardware\)](#)
- ▶ [HSR Statistics \(depends on hardware\)](#)

## 5.9.4.1 HSR Configuration (depends on hardware)

[ Switching > L2-Redundancy > HSR > Configuration ]

In this dialog you enable the *HSR* function, configure HSR supervision packets, and specify the function that the device executes in the HSR ring.

The *MRP* and *Spanning Tree* functions cannot operate on the same ports as the *HSR* function. Disable the *MRP* function or choose different ports. Deactivate the *Spanning Tree* function on the HSR ports.

**Note:** When HSR is active, it uses the interfaces *1/1* and *1/2*. As seen in the *Switching > Rate Limiter* and *Switching > Filter for MAC Addresses* dialogs, the *HSR* function replaces the interfaces *1/1* and *1/2* with the interface *hsr/1*. Set up the VLAN membership and the rate limiting for the interface *hsr/1*.

### Operation

Operation

Enables/disables the *HSR* function globally.

Possible values:

- ▶ *On*  
When this function is active, the device processes the data stream according to the set up.
- ▶ *Off* (default setting)

**Note:** When you use SFPs for HSR ports and the device only supports 100 Mbit/s, verify that the SFPs support 100 Mbit/s.

### Port A / Port B

Physical port

Displays the number of the physical port which the device uses as the HSR *Port A* or *Port B*.

Port A admin state

Enables/disables the *HSR* function on the port.

Possible values:

- ▶ *On* (default setting)  
The *HSR* function on the port is enabled.  
Consider that the *802.1AS* function does not work properly on the port when you enable the *HSR* function.
- ▶ *Off*  
The *HSR* function on the port is disabled.

## Supervision packet receiver

### Evaluate supervision packets

Activates/deactivates the supervision packet analysis.

Possible values:

- ▶ `marked` (default setting)  
Supervision packet analysis is active.  
The device receives supervision data packets and analyzes them.
- ▶ `unmarked`  
Supervision packet analysis is inactive.  
The device receives supervision data packets without analyzing them.

## Supervision packet sender

### Active

Enables/disables the transmission of supervision packets.

Possible values:

- ▶ `On` (default setting)  
The transmission of supervision packets is enabled. The RedBox transmits its own supervision packets.
- ▶ `Off`  
The transmission of supervision packets is disabled.

### Send VDAN packets

Activates/deactivates the transmission of VDAN supervision packets.

The prerequisite is that you enable the transmission of supervision packets. See the [Active](#) field.

Possible values:

- ▶ `marked`  
The transmission of VDAN supervision packets is active.  
The RedBox transmits both its own supervision packets and the supervision packets for the VDANs listed in the [HSR Proxy Node Table](#).
- ▶ `unmarked` (default setting)  
The transmission of VDAN supervision packets is inactive.

## Configuration (depends on hardware)

### MTU

Specifies the maximum allowed size of Ethernet packets on the interface in bytes.

Possible values:

- ▶ `1518..1530` (default setting: `1518`)  
With the setting `1518`, the port transmits the Ethernet packets up to the following size:

- 1518 bytes without VLAN tag  
(1514 bytes + 4 bytes CRC)
- 1522 bytes with VLAN tag  
(1518 bytes + 4 bytes CRC)

This setting lets you increase the max. allowed size of Ethernet packets that this interface receives or transmits.

**Note:** If you increase the value, then it can be necessary to increase the MTU size of other ports by the same amount. See the *MTU* column in the *Basic Settings > Port* dialog, *Configuration* tab.

#### Speed

Specifies the speed of the HSR interface. The prerequisite is that both HSR member ports operate with the specified speed.

Possible values:

- ▶ *100Mbps* (default setting)
- ▶ *1Gbps*

### HSR parameter

#### HSR mode

Specifies the forwarding capacity of the device for unicast traffic.

Possible values:

- ▶ *modeh* (default setting)  
If the host functions as a proxy for a destination device, then it removes unicast traffic from the ring and forwards it to the destination address.
- ▶ *modeu*  
If the host operates as a proxy for a destination device, then it forwards unicast traffic around the ring and forwards it to the destination address. If the packets return to the source node, then it discards the unicast traffic.

#### Switching node type

Specifies the function that the device executes in the HSR ring.

Possible values:

- ▶ *hsrredboxsan* (default setting)  
You use this setting if you connect SANs to the device within a HSR ring.
- ▶ *hsrredboxprpa*  
You use this setting to connect the corresponding device with PRP LAN A. Furthermore, set the *Redbox identity* parameter for the corresponding network connection.
- ▶ *hsrredboxprpb*  
You use this setting to connect the corresponding device with PRP LAN B. Furthermore, set the *Redbox identity* parameter for the corresponding network connection.

**Note:** If you specify the value *hsrredboxprpa* or *hsrredboxprpb*, then increase the MTU size on the interface. See the *Configuration* frame, *MTU* field.

Also increase the MTU size of the ports connected with LAN A and B in the PRP networks by the same amount. See the *MTU* column in the *Basic Settings > Port* dialog, *Configuration* tab.

### Redbox identity

Specifies the tags for the PRP LAN traffic.

The parameter identifies and tags the data traffic for the PRP LAN that you connect to this device. The device identifies the traffic for up to 7 PRP LANs that you connect to the HSR ring.

The prerequisite is that you specify the value *hsrredboxprpa* or *hsrredboxprpb* in the *Switching node type* field.

Possible values:

- ▶ *id1a* (default setting)  
Use this value to handle the HSR data traffic for LAN A in PRP network 1.
- ▶ *id1b*  
Use this value to handle the HSR data traffic for LAN B in PRP network 1.
- ▶ *id2a*  
Use this value to handle the HSR data traffic for LAN A in PRP network 2.
- ▶ *id2b*  
Use this value to handle the HSR data traffic for LAN B in PRP network 2.
- ▶ ...
- ▶ *id7a*  
Use this value to handle the HSR data traffic for LAN A in PRP network 7.
- ▶ *id7b*  
Use this value to handle the HSR data traffic for LAN B in PRP network 7.

### Buttons

You find the description of the standard buttons in section “Buttons” on page 14.

## 5.9.4.2 HSR DAN/VDAN Table (depends on hardware)

[Switching > L2-Redundancy > HSR > DAN/VDAN Table]

This dialog lets you analyze the LANs. This is helpful for example, when the *Last seen A* counter of one port continually increases while the *Last seen B* counter remains the same (and the other way round). This condition indicates an interruption of LAN connection.

DAN/VDAN means Double Attached Node / Virtual Double Attached Node.

### Table

Index

Displays the index number to which the table entry relates.

MAC address

Displays the MAC address of the node.

Last seen A

Displays the time between received first packets for this node on LAN A. When the counter threshold reaches 497 days, it restarts from 0.

Last seen B

Displays the time between received first packets for this node on LAN B. When the counter threshold reaches 497 days, it restarts from 0.

Remote node type

Displays the type of node.

Possible values:

- ▶ *redboxh*  
Management
- ▶ *vdanh*  
Client

### Buttons

You find the description of the standard buttons in section [“Buttons” on page 14](#).

Reset

Resets the entire table.

### 5.9.4.3 HSR Proxy Node Table (depends on hardware)

[Switching > L2-Redundancy > HSR > Proxy Node Table]

This dialog informs you of the connected devices for which this device provides HSR redundancy.

#### Table

Index

Displays the index number to which the table entry relates.

Possible values:

▶ 1..128

MAC address

Displays the MAC addresses of the connected devices for which this device implements HSR redundancy.

#### Buttons

You find the description of the standard buttons in section [“Buttons” on page 14](#).

Reset

Resets the entire table.

### 5.9.4.4 HSR Statistics (depends on hardware)

[ Switching > L2-Redundancy > HSR > Statistics ]

This dialog lists receive events for various MIB Managed Objects. Each entry represents link degradation for the MIB Managed Objects listed in the description column. The table lists how many times the event occurred for each path through the device. The Port A entries for example, specify the path between the transceiver, through the Link Redundancy Entity (LRE) to the UDP and TCP layers.

#### Table

Description

Displays the MIB Managed Objects description to which the *Port A*, *Port B*, and *Interlink* entries refer.

Port A

Displays the number of MIB Managed Objects events on *Port A*. The device examines the traffic as it passes from receive transceiver A to the LRE.

Port B

Displays the number of MIB Managed Objects events on *Port B*. The device examines the traffic as it passes from receive transceiver B to the LRE.

Interlink

Displays the number of MIB Managed Objects events on the interlink. The counters are active for the MIB Managed Objects that pertain to the interlink. The other counters remain empty. A sample is made of the traffic as it passes from the LRE to the switch.

CPU port

Displays the number of MIB Managed Objects events on the CPU Port. There is one MIB Managed Object that pertains to the CPU Port. The other counters remain empty. A sample is made of the traffic as it passes from receive transceiver to the CPU.

#### Buttons

You find the description of the standard buttons in section “Buttons” on page 14.

Reset

Resets the entire table.



## 5.9.5 Spanning Tree

[Switching > L2-Redundancy > Spanning Tree]

The Spanning Tree Protocol (STP) is a protocol that deactivates redundant paths of a network in order to help avoid loops. If a network component becomes inoperable on the path, then the device calculates the new topology and reactivates these paths.

The Rapid Spanning Tree Protocol (RSTP) enables fast switching to a newly calculated topology without interrupting existing connections. RSTP gets average reconfiguration times of less than a second. When you use RSTP in a ring with 10 to 20 devices, you can get reconfiguration times in the order of milliseconds.

**Note:** When you connect the device to the network through twisted pair SFPs instead of through usual twisted pair ports, the reconfiguration of the network takes slightly longer.

The menu contains the following dialogs:

- ▶ [Spanning Tree Global](#)
- ▶ [Spanning Tree Port](#)

## 5.9.5.1 Spanning Tree Global

[Switching > L2-Redundancy > Spanning Tree > Global]

In this dialog you enable/disable the *Spanning Tree* function and specify the bridge settings.

### Operation

Operation

Enables/disables the Spanning Tree function in the device.

Possible values:

▶ *On* (default setting)

▶ *Off*

The device behaves transparently. The device floods received Spanning Tree data packets like multicast data packets to the ports.

### Variant

Variant

Displays the protocol used for the *Spanning Tree* function:

Possible values:

▶ *rstp*

The protocol *RSTP* is active.

With RSTP (IEEE 802.1Q-2005), the *Spanning Tree* function operates for the underlying physical layer.

### Traps

Send trap

Activates/deactivates the sending of SNMP traps for the following events:

- Another bridge takes over the root bridge role.
- The topology changes. A port changes its *Port state* from *forwarding* into *discarding* or from *discarding* into *forwarding*.

Possible values:

▶ *marked*

The sending of SNMP traps is active.

▶ *unmarked* (default setting)

The sending of SNMP traps is inactive.

## Bridge configuration

### Bridge ID

Displays the bridge ID of the device.

The device with the lowest bridge ID numerical value takes over the role of the root bridge in the network.

Possible values:

- ▶ `<Bridge priority> / <MAC address>`  
Value in the *Priority* field / MAC address of the device

### Priority

Specifies the bridge priority of the device.

Possible values:

- ▶ `0..61440` in steps of 4096 (default setting: `32768`)

To make this device the root bridge, assign the lowest numeric priority value in the network to the device.

### Hello time [s]

Specifies the time in seconds between the sending of two configuration messages (Hello data packets).

Possible values:

- ▶ `1..2` (default setting: `2`)

If the device takes over the role of the root bridge, then the other devices in the network use the value specified here.

Otherwise, the device uses the value specified by the root bridge. See the *Root information* frame.

Due to the interaction with the *Tx holds* parameter, we recommend that you do not change the default setting.

### Forward delay [s]

Specifies the delay time for the status change in seconds.

Possible values:

- ▶ `4..30` (default setting: `15`)

If the device takes over the role of the root bridge, then the other devices in the network use the value specified here.

Otherwise, the device uses the value specified by the root bridge. See the *Root information* frame.

In the RSTP protocol, the bridges negotiate a status change without a specified delay.

The *Spanning Tree* protocol uses the parameter to delay the status change between the statuses *disabled*, *discarding*, *learning*, *forwarding*.

The parameters *Forward delay [s]* and *Max age* have the following relationship:

$Forward\ delay\ [s] \geq (Max\ age/2) + 1$

If you enter values in the fields that contradict this relationship, then the device replaces these values with the last valid values or with the default value.

#### Max age

Specifies the maximum permitted branch length for example, the number of devices to the root bridge.

Possible values:

▶ 6..40 (default setting: 20)

If the device takes over the role of the root bridge, then the other devices in the network use the value specified here.

Otherwise, the device uses the value specified by the root bridge. See the [Root information](#) frame.

The [Spanning Tree](#) protocol uses the parameter to specify the validity of STP-BPDUs in seconds.

#### Tx holds

Limits the maximum transmission rate for sending BPDUs.

Possible values:

▶ 1..40 (default setting: 10)

When the device sends a BPDU, the device increments a counter on this port.

If the counter reaches the value specified here, then the port stops sending BPDUs. On the one hand, this reduces the load generated by RSTP, and on the other when the device does not receive BPDUs, a communication interruption can be caused.

The device decrements the counter by 1 every second. In the following second, the device sends a maximum of 1 new BPDU.

#### BPDU guard

Activates/deactivates the BPDU Guard function in the device.

With this function, the device helps protect your network from incorrect configurations, attacks with STP-BPDUs, and unwanted topology changes.

Possible values:

▶ **marked**

The [BPDU guard](#) is active.

- The device applies the function to manually specified edge ports. For these ports, in the [Switching > L2-Redundancy > Spanning Tree > Port](#) dialog, [CIST](#) tab the checkbox in the [Admin edge port](#) column is marked.
- If an edge port receives an STP-BPDU, then the device disables the port. For this port, in the [Basic Settings > Port](#) dialog, [Configuration](#) tab the checkbox in the [Port on](#) column is **unmarked**.

▶ **unmarked** (default setting)

The [BPDU guard](#) is inactive.

To reset the status of the port to the value *forwarding*, you proceed as follows:

- If the port is still receiving BPDUs, then:
  - In the [Switching > L2-Redundancy > Spanning Tree > Port](#) dialog, *CIST* tab unmark the checkbox in the *Admin edge port* column.
  - or
  - In the [Switching > L2-Redundancy > Spanning Tree > Global](#) dialog, unmark the *BPDU guard* checkbox.
- To re-enable the port again you use the *Auto-Disable* function. Alternatively, proceed as follows:
  - Open the [Basic Settings > Port](#) dialog, *Configuration* tab.
  - Mark the checkbox in the *Port on* column.

#### BPDU filter (all admin edge ports)

Activates/deactivates the STP-BPDU filter on every manually specified edge port. For these ports, in the [Switching > L2-Redundancy > Spanning Tree > Port](#) dialog, *CIST* tab the checkbox in the *Admin edge port* column is marked.

Possible values:

- ▶ *marked*
  - The BPDU filter is active on every edge port.
  - The function does not use these ports in *Spanning Tree* operations.
  - The device does not send STP-BPDUs on these ports.
  - The device drops any STP-BPDUs received on these ports.
- ▶ *unmarked* (default setting)
  - The global BPDU filter is inactive.
  - You have the option to explicitly activate the BPDU filter for single ports. See the *Port BPDU filter* column in the [Switching > L2-Redundancy > Spanning Tree > Port](#) dialog.

#### Auto-disable

Activates/deactivates the *Auto-Disable* function for the parameters that *BPDU guard* is monitoring on the port.

Possible values:

- ▶ *marked*
  - The *Auto-Disable* function for the *BPDU guard* is active.
  - When the port receives an STP-BPDU, the device disables an edge port. The “Link status” LED for the port flashes 3× per period.
  - The [Diagnostics > Ports > Auto-Disable](#) dialog displays which ports are currently disabled due to the parameters being exceeded.
  - The *Auto-Disable* function reactivates the port automatically. For this you go to the [Diagnostics > Ports > Auto-Disable](#) dialog and specify a waiting period for the relevant port in the *Reset timer [s]* column.
- ▶ *unmarked* (default setting)
  - The *Auto-Disable* function for the *BPDU guard* is inactive.

## Root information

### Bridge ID

Displays the bridge ID of the current root bridge.

Possible values:

▶ `<Bridge priority> / <MAC address>`

### Priority

Displays the bridge priority of the current root bridge.

Possible values:

▶ `0..61440` in steps of 4096

### Hello time [s]

Displays the time in seconds that the root bridge specifies between the sending of two configuration messages (Hello data packets).

Possible values:

▶ `1..2`

The device uses this specified value. See the [Bridge configuration](#) frame.

### Forward delay [s]

Specifies the delay time in seconds set up by the root bridge for status changes.

Possible values:

▶ `4..30`

The device uses this specified value. See the [Bridge configuration](#) frame.

In the RSTP protocol, the bridges negotiate a status change without a specified delay.

The [Spanning Tree](#) protocol uses the parameter to delay the status change between the statuses *disabled*, *discarding*, *learning*, *forwarding*.

### Max age

Specifies the maximum permitted branch length that the root bridge sets up for example, the number of devices to the root bridge.

Possible values:

▶ `6..40` (default setting: 20)

The [Spanning Tree](#) protocol uses the parameter to specify the validity of STP-BPDUs in seconds.

## Topology information

### Bridge is root

Displays if the device currently has the role of the root bridge.

Possible values:

- ▶ `marked`  
The device currently has the role of the root bridge.
- ▶ `unmarked`  
Another device currently has the role of the root bridge.

### Root port

Displays the number of the port from which the current path leads to the root bridge.

If the device takes over the role of the root bridge, then the field displays the value `0`.

### Root path cost

Specifies the path cost for the path that leads from the root port of the device to the root bridge of the layer 2 network.

Possible values:

- ▶ `0..200000000`  
If the value `0` is specified, then the device takes over the role of the root bridge.

### Topology changes

Displays how many times the device has put a port into the *forwarding* status using the *Spanning Tree* function since the *Spanning Tree* instance was started.

### Time since topology change

Displays the time since the last topology change.

Possible values:

- ▶ `<days, hours:minutes:seconds>`

## Buttons

You find the description of the standard buttons in section “Buttons” on page 14.

## 5.9.5.2 Spanning Tree Port

[Switching > L2-Redundancy > Spanning Tree > Port]

In this dialog you activate the Spanning Tree function on the ports, specify edge ports, and specify the settings for various protection functions.

The dialog contains the following tabs:

- ▶ [CIST]
- ▶ [Guards]

### [CIST]

In this tab you have the option to activate the Spanning Tree function on the ports individually, specify the settings for edge ports, and view the current values. The abbreviation CIST stands for Common and Internal Spanning Tree.

**Note:** Deactivate the *Spanning Tree* function on the ports that are participating in other Layer 2 redundancy protocols. Otherwise, it is possible that the redundancy protocols operate differently than intended. This can cause loops.

### Table

Port

Displays the port number.

STP active

Activates/deactivates the Spanning Tree function on the port.

Possible values:

- ▶ *marked* (default setting)  
The *Spanning Tree* function is active on the port.
- ▶ *unmarked*  
The *Spanning Tree* function is inactive on the port.  
If the *Spanning Tree* function is enabled in the device and inactive on the port, then the port does not send STP-BPDUs and drops any STP-BPDUs received.

Port state

Displays the transmission status of the port.

Possible values:

- ▶ *discarding*  
The port is blocked and forwards only STP-BPDUs.
- ▶ *learning*  
The port is blocked, but it learns the MAC addresses of received data packets.
- ▶ *forwarding*  
The port forwards data packets.



- ▶ *disabled*  
The port is inactive. See the [Basic Settings > Port](#) dialog, [Configuration](#) tab.
- ▶ *manualFwd*  
The [Spanning Tree](#) function is disabled on the port. The port forwards STP-BPDUs.
- ▶ *notParticipate*  
The port is not participating in STP.

#### Port role

Displays the current role of the port in CIST.

Possible values:

- ▶ *root*  
Port with the cheapest path to the root bridge.
- ▶ *alternate*  
Port with the alternative path to the root bridge (currently blocking).
- ▶ *designated*  
Port for the side of the tree averted from the root bridge (currently blocking).
- ▶ *backup*  
Port receives STP-BPDUs from its own device.
- ▶ *disabled*  
The port is inactive. See the [Basic Settings > Port](#) dialog, [Configuration](#) tab.

#### Port path cost

Specifies the path costs of the port.

Possible values:

- ▶ `0..200000000` (default setting: 0)

When the value is 0, the device automatically calculates the path costs depending on the data rate of the port.

#### Port priority

Specifies the priority of the port.

Possible values:

- ▶ `16..240` in steps of 16 (default setting: 128)

This value represents the first 4 bits of the port ID.

#### Received bridge ID

Displays the bridge ID of the device from which this port last received an STP-BPDU.

Possible values:

- ▶ For ports with the *designated* role, the device displays the information for the STP-BPDU last received by the port. This helps to diagnose the possible STP problems in the network.
- ▶ For the *alternate*, *backup*, *master*, and *root* port roles, in the stationary condition (static topology) this information is identical to the information of the *designated* port role.
- ▶ If a port has no connection or if it did not receive any STP-BPDUs yet, then the device displays the values that the port can send with the *designated* role.

#### Received port ID

Displays the port ID of the device from which this port last received an STP-BPDU.

Possible values:

- ▶ For ports with the *designated* role, the device displays the information for the STP-BPDU last received by the port. This helps to diagnose the possible STP problems in the network.
- ▶ For the *alternate*, *backup*, *master*, and *root* port roles, in the stationary condition (static topology) this information is identical to the information of the *designated* port role.
- ▶ If a port has no connection or if it did not receive any STP-BPDUs yet, then the device displays the values that the port can send with the *designated* role.

#### Received path cost

Displays the path cost that the higher-level bridge has from its root port to the root bridge.

Possible values:

- ▶ For ports with the *designated* role, the device displays the information for the STP-BPDU last received by the port. This helps to diagnose the possible STP problems in the network.
- ▶ For the *alternate*, *backup*, *master*, and *root* port roles, in the stationary condition (static topology) this information is identical to the information of the *designated* port role.
- ▶ If a port has no connection or if it did not receive any STP-BPDUs yet, then the device displays the values that the port can send with the *designated* role.

#### Admin edge port

Activates/deactivates the *Admin edge port* mode. If the port is connected to an end device, then use the *Admin edge port* mode. This setting lets the edge port change faster to the forwarding state after linkup and thus a faster accessibility of the end device.

Possible values:

- ▶ *marked*  
The *Admin edge port* mode is active.  
The port is connected to an end device.
  - After the connection is set up, the port changes to the *forwarding* status without changing to the *learning* status beforehand.
  - If the port receives an STP-BPDU and the BPDU Guard function is active, then the device deactivates the port. See the [Switching > L2-Redundancy > Spanning Tree > Global](#) dialog.
- ▶ *unmarked* (default setting)  
The *Admin edge port* mode is inactive.  
The port is connected to another STP bridge.  
After the connection is set up, the port changes to the *learning* status before changing to the *forwarding* status, if applicable.

## Auto edge port

Activates/deactivates the automatic detection of whether you connect an end device to the port. The prerequisite is that the checkbox in the *Admin edge port* column is *unmarked*.

Possible values:

- ▶ *marked* (default setting)  
The automatic detection is active.  
After the installation of the connection and after  $1.5 \times \textit{Hello time [s]}$ , the device sets the port to the *forwarding* status (default setting  $1.5 \times 2$  s) if the port did not receive any STP-BPDUs during this time.
- ▶ *unmarked*  
The automatic detection is inactive.  
After the installation of the connection, and after *Max age* the device sets the port to the *forwarding* status.  
(default setting: 20 s)

## Oper edge port

Displays if an end device or an STP bridge is connected to the port.

Possible values:

- ▶ *marked*  
An end device is connected to the port. The port does not receive any STP-BPDUs.
- ▶ *unmarked*  
An STP bridge is connected to the port. The port receives STP-BPDUs.

## Oper PointToPoint

Displays if the port is connected to an STP device via a direct full-duplex link.

Possible values:

- ▶ *marked*  
The port is connected directly to an STP device via a full-duplex link. The direct, decentralized communication between 2 bridges enables short reconfiguration times.
- ▶ *unmarked*  
The port is connected in another way, for example via a half-duplex link or via a hub.

## Port BPDU filter

Activates/deactivates the filtering of STP-BPDUs on the port explicitly.

The prerequisite is that the port is a manually specified edge port. For these ports, the checkbox in the *Admin edge port* column is marked.

Possible values:

- ▶ *marked*  
The BPDU filter is active on the port.  
The function excludes the port from *Spanning Tree* operations.
  - The device does not send STP-BPDUs on the port.
  - The device drops any STP-BPDUs received on the port.
- ▶ *unmarked* (default setting)  
The BPDU filter is inactive on the port.  
You have the option to globally activate the BPDU filter for every edge port. See the *Switching > L2-Redundancy > Spanning Tree > Global* dialog, *Bridge configuration* frame.  
If the *BPDU filter (all admin edge ports)* checkbox is marked, then the BPDU filter is still active on the port.

#### BPDU filter status

Displays if the BPDU filter is active on the port.

Possible values:

- ▶ **marked**  
The BPDU filter is active on the port as a result of the following settings:
  - The checkbox in the *Port BPDU filter* column is marked.  
and/or
  - The checkbox in the *BPDU filter (all admin edge ports)* column is marked. See the *Switching > L2-Redundancy > Spanning Tree > Global* dialog, *Bridge configuration* frame.
- ▶ **unmarked**  
The BPDU filter is inactive on the port.

#### BPDU flood

Activates/deactivates the *BPDU flood* mode on the port even if the *Spanning Tree* function is inactive on the port. The device floods STP-BPDUs received on the port to the ports for which the *Spanning Tree* function is inactive and the *BPDU flood* mode is active too.

Possible values:

- ▶ **marked**  
The *BPDU flood* mode is active.
- ▶ **unmarked** (default setting)  
The *BPDU flood* mode is inactive.

### Buttons

You find the description of the standard buttons in section “Buttons” on page 14.

### [Guards]

This tab lets you specify the settings for various protection functions on the ports.

### Table

#### Port

Displays the port number.

#### Root guard

Activates/deactivates the monitoring of STP-BPDUs on the port. The prerequisite is that the *Loop guard* function is inactive.

With this setting the device helps you protect your network from incorrect configurations or attacks with STP-BPDUs that try to change the topology. This setting is relevant only for ports with the STP role *designated*.

Possible values:

- ▶ `marked`  
The monitoring of STP-BPDUs is active.
  - If the port receives an STP-BPDU with better path information to the root bridge, then the device discards the STP-BPDU and sets the status of the port to the value `discarding` instead of `root`.
  - If there are no STP-BPDUs with better path information to the root bridge, then the device resets the status of the port after  $2 \times$  `Hello time [s]`.
- ▶ `unmarked` (default setting)  
The monitoring of STP-BPDUs is inactive.

#### TCN guard

Activates/deactivates the monitoring of "Topology Change Notifications" on the port. With this setting the device helps you protect your network from attacks with STP-BPDUs that try to change the topology.

Possible values:

- ▶ `marked`  
The monitoring of "Topology Change Notifications" is enabled.
  - The port ignores the Topology Change flag in received STP-BPDUs.
  - If the received BPDU contains other information that causes a topology change, then the device processes the BPDU even if the TCN guard is enabled.  
Example: The device receives better path information for the root bridge.
- ▶ `unmarked` (default setting)  
The monitoring of "Topology Change Notifications" is disabled.  
If the device receives STP-BPDUs with a Topology Change flag, then the device deletes the address table of the port and forwards the Topology Change Notifications.

#### Loop guard

Activates/deactivates the monitoring of loops on the port. The prerequisite is that the `Root guard` function is inactive.

With this setting the device helps prevent loops if the port does not receive any more STP-BPDUs. Use this setting only for ports with the STP role `alternate`, `backup` or `root`.

Possible values:

- ▶ `marked`  
The monitoring of loops is active. This helps prevent loops for example, if you disable the Spanning Tree function on the remote device or if the connection is interrupted only in the receiving direction.
  - If the port does not receive any STP-BPDUs for a while, then the device sets the status of the port to the value `discarding` and marks the checkbox in the `Loop state` column.
  - If the port receives STP-BPDUs again, then the device sets the status of the port to a value according to `Port role` and unmarks the checkbox in the `Loop state` column.
- ▶ `unmarked` (default setting)  
The monitoring of loops is inactive.  
If the port does not receive any STP-BPDUs for a while, then the device sets the status of the port to the value `forwarding`.

## Loop state

Displays if the loop state of the port is inconsistent.

Possible values:

▶ *marked*

The loop state of the port is inconsistent:

- The port is not receiving any STP-BPDUs and the *Loop guard* function is enabled.
- The device sets the state of the port to the value *discarding*. The device thus helps prevent any potential loops.

▶ *unmarked*

The loop state of the port is consistent. The port receives STP-BPDUs.

## Trans. into loop

Displays how many times the loop state of the port became inconsistent (marked checkbox in the *Loop state* column).

## Trans. out of loop

Displays how many times the loop state of the port became consistent (unmarked checkbox in the *Loop state* column).

## BPDU guard effect

Displays if the port received an STP-BPDU as an edge port.

Prerequisite:

- The port is a manually specified edge port. In the *Port* dialog, the checkbox for this port in the *Admin edge port* column is *marked*.
- In the *Switching > L2-Redundancy > Spanning Tree > Global* dialog, the BPDU Guard function is active.

Possible values:

▶ *marked*

The port is an edge port and received an STP-BPDU.

The device deactivates the port. For this port, in the *Basic Settings > Port* dialog, *Configuration* tab the checkbox in the *Port on* column is *unmarked*.

▶ *unmarked*

The port is an edge port and has not received any STP-BPDUs, or the port is not an edge port.

To reset the status of the port to the value *forwarding*, you proceed as follows:

- If the port is still receiving BPDUs, then:
  - In the *CIST* tab, unmark the checkbox in the *Admin edge port* column.
  - or
  - In the *Switching > L2-Redundancy > Spanning Tree > Global* dialog, unmark the *BPDU guard* checkbox.
- To activate the port, proceed as follows:
  - Open the *Basic Settings > Port* dialog, *Configuration* tab.
  - Mark the checkbox in the *Port on* column.

## Buttons

You find the description of the standard buttons in section “Buttons” on page 14.

## 5.9.6 Link Aggregation

[Switching > L2-Redundancy > Link Aggregation]

The *Link Aggregation* function lets you aggregate multiple parallel links. The prerequisite is that the links have the same speed and are full duplex. The advantages compared to conventional connections using a single line are higher availability and a higher transmission bandwidth.

The criteria for distributing the load to the parallel links are based on the *Hashing option* function.

The Link Aggregation Control Protocol (LACP) makes it possible to monitor the packet-based continuous link status on the physical ports. LACP also helps ensure that the link partners meet the aggregation prerequisites.

If the remote side does not support the Link Aggregation Control Protocol (LACP), then you can use the *Static link aggregation* function. In this case, the device aggregates the links based on the link, link speed and duplex setting.

### Configuration

#### Hashing option

Specifies which information the device uses to distribute the packets to the physical ports of the LAG interface. The device transmits packets containing the same distribution-relevant information over the same physical port to keep the packet order.

This setting overwrites the value specified in the *Hashing option* column for the port.

Possible values:

- ▶ *sourceMacVlan*  
The device uses the *Source MAC address*, *VLAN ID*, *EtherType* fields of the packet, and the physical ingress port.
- ▶ *destMacVlan*  
The device uses the *Destination MAC address*, *VLAN ID*, *EtherType* fields of the packet, and the physical ingress port.
- ▶ *sourceDestMacVlan* (default setting)  
The device uses the *Source MAC address*, *Destination MAC address*, *VLAN ID*, *EtherType* fields of the packet, and the physical ingress port.
- ▶ *sourceIPsourcePort*  
The device uses the *Source IP address* and *Source TCP/UDP port* fields of the packet.
- ▶ *destIPdestPort*  
The device uses the *Destination IP address* and *Destination TCP/UDP port* fields of the packet.
- ▶ *sourceDestIPPort*  
The device uses the *Source IP address*, *Destination IP address*, *Source TCP/UDP port*, and *Destination TCP/UDP port* fields of the packet.

## Table

Trunk port

Displays the LAG interface number.

Name

Specifies the name of the LAG interface.

Possible values:

- ▶ Alphanumeric ASCII character string with 1..15 characters

Link/Status

Displays the current operating state of the LAG interface and the physical ports.

Possible values:

- ▶ *up* (*lag/... row*)  
The LAG interface is operational.  
The prerequisites are:
  - The *Static link aggregation* function is active on this LAG interface.  
or
  - LACP is active on the physical ports assigned to the LAG interface, see the *LACP active* column.  
and  
The key specified for the LAG interface in the *LACP admin key* column matches the keys specified for the physical ports in the *LACP port actor admin key* column.  
and  
The number of operational physical ports assigned to the LAG interface is greater than or equal to the value specified in the *Active ports (min.)* column.
- ▶ *up*  
The physical port is operational.
- ▶ *down* (*lag/... row*)  
The LAG interface is down.
- ▶ *down*  
The physical port is disabled.  
or  
No cable connected or no active link.

Active

Activates/deactivates the LAG interface.

Possible values:

- ▶ *marked* (default setting)  
The LAG interface is active.  
Consider that the following protocols do not work properly on the physical ports when you activate the LAG interface:
  - *PTP*
  - *802.1AS*
- ▶ *unmarked*  
The LAG interface is inactive.



## STP active

Activates/deactivates the *Spanning Tree* protocol on this LAG interface. The prerequisite is that you enable the *Spanning Tree* function globally in the *Switching > L2-Redundancy > Spanning Tree > Global* dialog.

You can also activate/deactivate the *Spanning Tree* protocol on the LAG interfaces in the *Switching > L2-Redundancy > Spanning Tree > Port* dialog.

Possible values:

- ▶ *marked* (default setting)  
The *Spanning Tree* protocol is active on this LAG interface.
- ▶ *unmarked*  
The *Spanning Tree* protocol is inactive on this LAG interface.

## Static link aggregation

Activates/deactivates the *Static link aggregation* function on the LAG interface. The device aggregates the assigned physical ports to the LAG interface, even if the remote site does not support LACP.

Possible values:

- ▶ *marked*  
The *Static link aggregation* function is active on this LAG interface. The device aggregates an assigned physical port to the LAG interface as soon as the physical port gets a link. The device does not send LACPDU and discards received LACPDU.
- ▶ *unmarked* (default setting)  
The *Static link aggregation* function is inactive on this LAG interface. If the connection was successfully negotiated using LACP, then the device aggregates an assigned physical port to the LAG interface.

## Hashing option

Specifies which information the device uses to distribute the packets to the individual physical ports of the LAG interface. This setting has priority over the value selected in the *Configuration* frame, *Hashing option* drop-down list.

For further information on the values, see the description of the *Hashing option* drop-down list in the *Configuration* frame.

## MTU

Specifies the maximum allowed size of Ethernet packets on the LAG interface in bytes. Any present VLAN tag is not taken into account.

This setting lets you increase the size of the Ethernet packets for specific applications.

Possible values:

- ▶ *1518..12288* (default setting: *1518*)  
With the value *1518*, the LAG interface transmits the Ethernet packets up to the following size:
  - 1518 bytes without VLAN tag  
(1514 bytes + 4 bytes CRC)
  - 1522 bytes with VLAN tag  
(1518 bytes + 4 bytes CRC)

#### Active ports (min.)

Specifies the minimum number of physical ports to be active for the LAG interface to stay active. If the number of active physical ports is lower than the specified value, then the device deactivates the LAG interface.

If a redundancy function like *Spanning Tree* is active in the device, then you use this function to force the device to switch automatically to the redundant line.

Possible values:

- ▶ 1 (default setting)
- ▶ 2
- ▶ Depending on the hardware:
  - 4
  - 8
  - 32

#### Type

Displays if the LAG interface is based on the *Static link aggregation* function or on LACP.

Possible values:

- ▶ *static*  
The LAG interface is based on the *Static link aggregation* function.
- ▶ *dynamic*  
The LAG interface is based on LACP.

#### Send trap (Link up/down)

Activates/deactivates the sending of SNMP traps when the device detects changes in the link up/down status for this interface.

Possible values:

- ▶ *marked* (default setting)  
The sending of SNMP traps is active.  
If the device detects a link up/down status change, then the device sends an SNMP trap.
- ▶ *unmarked*  
The sending of SNMP traps is inactive.

The prerequisite for sending SNMP traps is that you enable the function in the *Diagnostics > Status Configuration > Alarms (Traps)* dialog and specify at least one trap destination.

#### LACP admin key

Specifies the LAG interface key. The device uses this key to identify the ports that can be aggregated to the LAG interface.

Possible values:

- ▶ 0..65535  
You specify the corresponding value for the physical ports in the *LACP port actor admin key* column.

#### Port

Displays the physical ports number assigned to the LAG interface.

### Aggregation port status

Displays if the LAG interface aggregates the physical port.

Possible values:

- ▶ *active*  
The LAG interface aggregates the physical port.
- ▶ *inactive*  
The LAG interface does not aggregate the physical port.

### LACP active

Activates/deactivates LACP on the physical port.

Possible values:

- ▶ *marked* (default setting)  
LACP is active on the physical port.
- ▶ *unmarked*  
LACP is inactive on the physical port.

### LACP port actor admin key

Specifies the physical port key. The device uses this key to identify the ports that can be aggregated to the LAG interface.

Possible values:

- ▶ *0*  
The device ignores the key on this physical port when deciding to aggregate the port into the LAG interface.
- ▶ *1..65535*  
If this value matches the value of the LAG interface specified in the *LACP admin key* column, then the device only aggregates this physical port to the LAG interface.

### LACP actor admin state

Specifies the actor state values that the LAG interface transmits in the LACPDUs. This lets you control the LACPDU parameters.

The device lets you mix the values. In the drop-down list, select one or more values.

Possible values:

- ▶ *ACT*  
(*LACP\_Activity* state)  
When selected, the link transmits the LACPDUs cyclically, otherwise when requested.
- ▶ *STO*  
(*LACP\_Timeout* state)  
When selected, the link transmits the LACPDUs cyclically using the short timeout, otherwise using the long timeout.
- ▶ *AGG*  
(*Aggregation* state)  
When selected, the device interprets the link as a candidate for aggregation, otherwise as an individual link.

For further information on the values, see the standard IEEE 802.1AX-2014.

#### LACP actor oper state

Displays the actor state values that the LAG interface transmits in the LACPDUs.

Possible values:

- ▶ *ACT*  
(LACP\_Activity state)  
When visible, the link transmits the LACPDUs cyclically, otherwise when requested.
- ▶ *STO*  
(LACP\_Timeout state)  
When visible, the link transmits the LACPDUs cyclically using the short timeout, otherwise using the long timeout.
- ▶ *AGG*  
(Aggregation state)  
When visible, the device interprets the link as a candidate for aggregation, otherwise as an individual link.
- ▶ *SYN*  
(Synchronization state)  
When visible, the device interprets the link as *IN\_SYNC*, otherwise as *OUT\_OF\_SYNC*.
- ▶ *COL*  
(Collecting state)  
When visible, collection of incoming frames is enabled on this link, otherwise disabled.
- ▶ *DST*  
(Distributing state)  
When visible, distribution of outgoing frames is enabled on this link, otherwise disabled.
- ▶ *DFT*  
(Defaulted state)  
When visible, the link uses defaulted operational information, administratively specified for the Partner. Otherwise the link uses the operational information received from a LACPDU.
- ▶ *EXP*  
(Expired state)  
When visible, the link receiver is in the *EXPIRED* state.

#### LACP partner oper SysID

Displays the MAC address of the remote device connected to this physical port.

The LAG interface has received this information in a LACPDU from the partner.

#### LACP partner oper port

Displays the port number of the remote device connected to this physical port.

The LAG interface has received this information in a LACPDU from the partner.

#### LACP partner oper port state

Displays the partner state values that the LAG interface receives in the LACPDUs.

Possible values:

- ▶ *ACT*
- ▶ *STO*
- ▶ *AGG*
- ▶ *SYN*
- ▶ *COL*

- ▶ *DST*
- ▶ *DFT*
- ▶ *EXP*

For further information on the values, see the description of the *LACP actor oper state* column and the standard IEEE 802.1AX-2014.

### Buttons

You find the description of the standard buttons in section “Buttons” on page 14.



Opens the *Create* window to add a new LAG interface entry to the table or to assign a physical port to a LAG interface.

- ▶ In the *Trunk port* drop-down list, you select the LAG interface number.
- ▶ In the *Port* drop-down list, you select the number of a physical port to assign to the LAG interface.

After you create a LAG interface, the device adds the LAG interface to the table in the *Basic Settings > Port* dialog, *Statisticstab*.

## 5.9.7 Link Backup

[ Switching > L2-Redundancy > Link Backup ]

With Link Backup, you configure pairs of redundant links. Each pair has a primary port and a backup port. The primary port forwards traffic until the device detects an error. If the device detects an error on the primary port, then the Link Backup function transfers traffic over to the backup port.

The dialog also lets you set a fail back option. If you enable the fail back function and the primary port returns to normal operation, then the device first blocks traffic on the backup port and then forwards traffic on the primary port. This process helps protect the device from causing loops in the network.

### Operation

#### Operation

Enables/disables the Link Backup function globally in the device.

Possible values:

- ▶ *On*  
Enables the Link Backup function.
- ▶ *Off* (default setting)  
Disables the Link Backup function.

**Table**

## Primary port

Displays the primary port of the interface pair. When you enable the Link Backup function, this port is responsible for forwarding traffic.

Possible values:

- ▶ Physical ports

## Backup port

Displays the backup port on which the device forwards traffic if the device detects an error on the primary port.

Possible values:

- ▶ Physical ports except for the port you set as the primary port.

## Description

Specifies the Link Backup pair. Enter a name to identify the Backup pair.

Possible values:

- ▶ Alphanumeric ASCII character string with 0..255 characters

## Primary port status

Displays the status of the primary port for this Link Backup pair.

Possible values:

- ▶ *forwarding*  
The link is up, no shutdown, and forwarding traffic.
- ▶ *blocking*  
The link is up, no shutdown, and blocking traffic.
- ▶ *down*  
The port is either link down, cable unplugged, or disabled in software, shutdown.
- ▶ *unknown*  
The Link Backup feature is globally disabled, or the port pair is inactive. Therefore, the device ignores the port pair settings.

## Backup port status

Displays the status of the Backup port for this Link Backup pair.

Possible values:

- ▶ *forwarding*  
The link is up, no shutdown, and forwarding traffic.
- ▶ *blocking*  
The link is up, no shutdown, and blocking traffic.
- ▶ *down*  
The port is either link down, cable unplugged, or disabled in the software, shutdown.
- ▶ *unknown*  
The Link Backup feature is globally disabled, or the port pair is inactive. Therefore, the device ignores the port pair settings.

## Fail back

Activates/deactivates the automatic fail back.

Possible values:

- ▶ `marked` (default setting)  
The automatic fail back is active.  
After the delay timer expires, the backup port changes to `blocking` and the primary port changes to `forwarding`.
- ▶ `unmarked`  
The automatic fail back is inactive.  
The backup port continues forwarding traffic even after the primary port re-establishes a link or you manually change the admin status of the primary port from `shutdown` to `no shutdown`.

## Fail back delay [s]

Specifies the delay time in seconds that the device waits after the primary port re-establishes a link. Furthermore, this timer also applies when you manually set the admin status of the primary port from `shutdown` to `no shutdown`. After the delay timer expires, the backup port changes to `blocking` and the primary port changes to `forwarding`.

Possible values:

- ▶ `0..3600` (default setting: 30)  
When set to 0, immediately after the primary port re-establishes a link, the backup port changes to `blocking` and the primary port changes to `forwarding`. Furthermore, immediately after you manually set the admin status of from `shutdown` to `no shutdown`, the backup port changes to `blocking` and the primary port changes to `forwarding`.

## Active

Activates/deactivates the Link Back up pair configuration.

Possible values:

- ▶ `marked`  
The Link Backup pair is active. The device senses the link and administration status and forwards traffic according to the pair configuration.
- ▶ `unmarked` (default setting)  
The Link Backup pair is inactive. The ports forward traffic according to standard switching.

## Buttons

You find the description of the standard buttons in section “Buttons” on page 14.



## Create

### Primary port

Specifies the primary port of the backup interface pair. During normal operation this port is responsible for forwarding the traffic.

Possible values:

- ▶ Physical ports

### Backup port

Specifies the backup port to which the device transfers the traffic to if the device detects an error on the primary port.

Possible values:

- ▶ Physical ports except for the port you set as the primary port.

## 6 Diagnostics

The menu contains the following dialogs:

- ▶ [Status Configuration](#)
- ▶ [System](#)
- ▶ [Syslog](#)
- ▶ [Ports](#)
- ▶ [LLDP](#)
- ▶ [Report](#)

### 6.1 Status Configuration

[Diagnostics > Status Configuration]

The menu contains the following dialogs:

- ▶ [Device Status](#)
- ▶ [Security Status](#)
- ▶ [Signal Contact](#)
- ▶ [MAC Notification](#)
- ▶ [Alarms \(Traps\)](#)

## 6.1.1 Device Status

[Diagnostics > Status Configuration > Device Status]

The device status provides an overview of the overall condition of the device. Many process visualization systems record the device status for a device in order to present its condition in graphic form.

The device displays its current status as *error* or *ok* in the *Device status* frame. The device determines this status from the individual monitoring results.

The device displays detected faults in the *Status* tab and also in the *Basic Settings > System* dialog, *Device Status* frame.

The dialog contains the following tabs:

- ▶ [Global]
- ▶ [Port]
- ▶ [Status]

### [Global]

#### Device status

Device status

Displays the current status of the device. The device determines the status from the individual monitored parameters.

Possible values:

- ▶ *error*  
The device displays this value to indicate a detected error in one of the monitored parameters.
- ▶ *ok*

#### Traps

Send trap

Activates/deactivates the sending of SNMP traps when the device detects changes in the monitored functions.

Possible values:

- ▶ *marked* (default setting)  
The sending of SNMP traps is active.  
If the device detects a change in the monitored functions, then the device sends an SNMP trap.
- ▶ *unmarked*  
The sending of SNMP traps is inactive.

The prerequisite for sending SNMP traps is that you enable the function in the *Diagnostics > Status Configuration > Alarms (Traps)* dialog and specify at least one trap destination.

## Table

### Temperature

Activates/deactivates the monitoring of the temperature in the device.

Possible values:

- ▶ `marked` (default setting)  
Monitoring is active.  
If the temperature exceeds or falls below the specified limit, then in the *Device status* frame, the value changes to *error*.
- ▶ `unmarked`  
Monitoring is inactive.

You specify the temperature thresholds in the *Basic Settings > System* dialog, *Upper temp. limit [°C]* field and *Lower temp. limit [°C]* field.

### Ring redundancy

Activates/deactivates the monitoring of the ring redundancy.

Possible values:

- ▶ `marked`  
Monitoring is active.  
In the *Device status* frame, the value changes to *error* in the following situations:
  - The redundancy function becomes active (loss of redundancy reserve).
  - The device is a normal ring participant and detects an error in its settings.
- ▶ `unmarked` (default setting)  
Monitoring is inactive.

### Connection errors

Activates/deactivates the monitoring of the link status of the port/interface.

Possible values:

- ▶ `marked`  
Monitoring is active.  
If the link interrupts on a monitored port/interface, then in the *Device status* frame, the value changes to *error*.  
In the *Port* tab, you have the option of selecting the ports/interfaces to be monitored individually.
- ▶ `unmarked` (default setting)  
Monitoring is inactive.

### Ethernet module removal

Activates/deactivates the monitoring of the modules.

Possible values:

- ▶ `marked`  
Monitoring is active.  
If you remove a module from the device, then in the *Device status* frame, the value changes to *error*.  
Further down, you have the option of selecting the modules to be monitored individually.
- ▶ `unmarked` (default setting)  
Monitoring is inactive.

### External memory removal

Activates/deactivates the monitoring of the active external memory.

Possible values:

- ▶ `marked`  
Monitoring is active.  
If you remove the active external memory from the device, then in the *Device status* frame, the value changes to *error*.
- ▶ `unmarked` (default setting)  
Monitoring is inactive.

You specify the active external memory in the *Basic Settings > Load/Save* dialog, *External memory* frame.

### External memory not in sync

Activates/deactivates the monitoring of the configuration profile in the device and in the external memory.

Possible values:

- ▶ `marked`  
Monitoring is active.  
In the *Device status* frame, the value changes to *error* in the following situations:
  - The configuration profile only exists in the device.
  - The configuration profile in the device differs from the configuration profile in the external memory.
- ▶ `unmarked` (default setting)  
Monitoring is inactive.

### Power supply

Activates/deactivates the monitoring of the power supply unit.

Possible values:

- ▶ `marked` (default setting)  
Monitoring is active.  
If the device has a detected power supply fault, then in the *Device status* frame, the value changes to *error*.
- ▶ `unmarked`  
Monitoring is inactive.

### Module

Activates/deactivates the monitoring of this module.

Possible values:

- ▶ `marked`  
Monitoring is active.  
If you remove the module from the device, then in the *Device status* frame, the value changes to *error*.
- ▶ `unmarked` (default setting)  
Monitoring is inactive.

This setting is effective when you mark the *Ethernet module removal* checkbox further up.

## Buttons

You find the description of the standard buttons in section “Buttons” on page 14.

### [Port]

#### Table

Port

Displays the port number.

Propagate connection error

Activates/deactivates the monitoring of the link on the port/interface.

Possible values:

- ▶ `marked`  
Monitoring is active.  
If the link on the selected port/interface is interrupted, then in the *Device status* frame, the value changes to *error*.
- ▶ `unmarked` (default setting)  
Monitoring is inactive.

This setting takes effect when you mark the *Connection errors* checkbox in the *Global* tab.

## Buttons

You find the description of the standard buttons in section “Buttons” on page 14.

### [Status]

#### Table

Timestamp

Displays the date and time of the event in the format, *Month Day, Year hh:mm:ss AM/PM*.

Cause

Displays the event which caused the SNMP trap.

## **Buttons**

You find the description of the standard buttons in section [“Buttons” on page 14](#).

## 6.1.2 Security Status

[Diagnostics > Status Configuration > Security Status]

This dialog gives you an overview of the status of the safety-relevant settings in the device.

The device displays its current status as *error* or *ok* in the *Security status* frame. The device determines this status from the individual monitoring results.

The device displays detected faults in the *Status* tab and also in the *Basic Settings > System* dialog, *Security status* frame.

The dialog contains the following tabs:

- ▶ [Global]
- ▶ [Port]
- ▶ [Status]

### [Global]

#### Security status

Security status

Displays the current status of the security-relevant settings in the device. The device determines the status from the individual monitored parameters.

Possible values:

- ▶ *error*  
The device displays this value to indicate a detected error in one of the monitored parameters.
- ▶ *ok*

#### Traps

Send trap

Activates/deactivates the sending of SNMP traps when the device detects changes in the monitored functions.

Possible values:

- ▶ *marked*  
The sending of SNMP traps is active.  
If the device detects a change in the monitored functions, then the device sends an SNMP trap.
- ▶ *unmarked* (default setting)  
The sending of SNMP traps is inactive.

The prerequisite for sending SNMP traps is that you enable the function in the *Diagnostics > Status Configuration > Alarms (Traps)* dialog and specify at least one trap destination.



## Table

### Password default settings unchanged

Activates/deactivates the monitoring of the password for the locally set up user accounts `user` and `admin`.

Possible values:

- ▶ `marked` (default setting)  
Monitoring is active.  
If the password is set to the default setting for the `user` or `admin` user accounts, then in the `Security status` frame, the value changes to `error`.
- ▶ `unmarked`  
Monitoring is inactive.

You set the password in the `Device Security > User Management` dialog.

### Min. password length < 8

Activates/deactivates the monitoring of the `Min. password length` policy.

Possible values:

- ▶ `marked` (default setting)  
Monitoring is active.  
If the value for the `Min. password length` policy is less than 8, then in the `Security status` frame, the value changes to `error`.
- ▶ `unmarked`  
Monitoring is inactive.

You specify the `Min. password length` policy in the `Device Security > User Management` dialog in the `Configuration` frame.

### Password policy settings deactivated

Activates/deactivates the monitoring of the Password policies settings.

Possible values:

- ▶ `marked` (default setting)  
Monitoring is active.  
If the value for at least one of the following policies is less than 1, then in the `Security status` frame, the value changes to `error`.
  - `Upper-case characters (min.)`
  - `Lower-case characters (min.)`
  - `Digits (min.)`
  - `Special characters (min.)`
- ▶ `unmarked`  
Monitoring is inactive.

You specify the policy settings in the `Device Security > User Management` dialog in the `Password policy` frame.

## User account password policy check deactivated

Activates/deactivates the monitoring of the *Policy check* function.

Possible values:

▶ *marked*

Monitoring is active.

If the *Policy check* function is inactive for at least one user account, then in the *Security status* frame, the value changes to *error*.

▶ *unmarked* (default setting)

Monitoring is inactive.

You activate the *Policy check* function in the *Device Security > User Management* dialog.

## Telnet server active

Activates/deactivates the monitoring of the Telnet server.

Possible values:

▶ *marked* (default setting)

Monitoring is active.

If you enable the Telnet server, then in the *Security status* frame, the value changes to *error*.

▶ *unmarked*

Monitoring is inactive.

You enable/disable the Telnet server in the *Device Security > Management Access > Server* dialog, *Telnet* tab.

## HTTP server active

Activates/deactivates the monitoring of the HTTP server.

Possible values:

▶ *marked* (default setting)

Monitoring is active.

If you enable the HTTP server, then in the *Security status* frame, the value changes to *error*.

▶ *unmarked*

Monitoring is inactive.

You enable/disable the HTTP server in the *Device Security > Management Access > Server* dialog, *HTTP* tab.

## SNMP unencrypted

Activates/deactivates the monitoring of the SNMP server.

Possible values:

▶ *marked* (default setting)

Monitoring is active.

If at least one of the following conditions applies, then in the *Security status* frame, the value changes to *error*:

- The *SNMPv1* function is enabled.

- The *SNMPv2* function is enabled.
- The encryption for SNMPv3 is disabled.  
You enable the encryption in the *Device Security > User Management* dialog, in the *SNMP encryption type* column.

- ▶ *unmarked*  
Monitoring is inactive.

You specify the settings for the SNMP agent in the *Device Security > Management Access > Server* dialog, *SNMP* tab.

### Access to system monitor with serial interface possible

Activates/deactivates the monitoring of the system monitor.

When the system monitor is activated, you have the possibility to change to the system monitor via a serial connection.

Possible values:

- ▶ *marked*  
Monitoring is active.  
If you activate the system monitor, then in the *Security status* frame, the value changes to *error*.
- ▶ *unmarked* (default setting)  
Monitoring is inactive.

You activate/deactivate the system monitor in the *Diagnostics > System > Selftest* dialog.

### Saving the configuration profile on the external memory possible

Activates/deactivates the monitoring of the configuration profile in the external memory.

Possible values:

- ▶ *marked*  
Monitoring is active.  
If you activate the saving of the configuration profile in the external memory, then in the *Security status* frame, the value changes to *error*.
- ▶ *unmarked* (default setting)  
Monitoring is inactive.

You activate/deactivate the saving of the configuration profile in the external memory in the *Basic Settings > External Memory* dialog.

### Link interrupted on enabled device ports

Activates/deactivates the monitoring of the link on the active ports.

Possible values:

- ▶ *marked*  
Monitoring is active.  
If the link interrupts on an active port, then in the *Security status* frame, the value changes to *error*. In the *Port* tab, you have the option of selecting the ports to be monitored individually.
- ▶ *unmarked* (default setting)  
Monitoring is inactive.

## Access with HiDiscovery possible

Activates/deactivates the monitoring of the HiDiscovery function.

Possible values:

▶ **marked** (default setting)

Monitoring is active.

If you enable the HiDiscovery function, then in the *Security status* frame, the value changes to *error*.

▶ **unmarked**

Monitoring is inactive.

You enable/disable the HiDiscovery function in the *Basic Settings > Network* dialog.

## Load unencrypted config from external memory

Activates/deactivates the monitoring of loading unencrypted configuration profiles from the external memory.

Possible values:

▶ **marked** (default setting)

Monitoring is active.

If the settings allow the device to load an unencrypted configuration profile from the external memory, then in the *Security status* frame, the value changes to *error*.

If the following preconditions are fulfilled, then the *Security status* frame in the *Basic Settings > System* dialog, displays an alarm.

– The configuration profile stored in the external memory is unencrypted.

and

– The *Config priority* column in the *Basic Settings > External Memory* dialog has the value *first* or *second*.

▶ **unmarked**

Monitoring is inactive.

## IEC61850-MMS active

Activates/deactivates the monitoring of the *IEC61850-MMS* function.

Possible values:

▶ **marked** (default setting)

Monitoring is active.

If you enable the *IEC61850-MMS* function, then in the *Security status* frame, the value changes to *error*.

▶ **unmarked**

Monitoring is inactive.

You enable/disable the *IEC61850-MMS* function in the *Industrial Protocols > IEC61850-MMS* dialog, *Operation* frame.

### Self-signed HTTPS certificate present

Activates/deactivates the monitoring of the HTTPS certificate.

Possible values:

- ▶ `marked` (default setting)  
Monitoring is active.  
If the HTTPS server uses a self-created digital certificate, then in the *Security status* frame, the value changes to *error*.
- ▶ `unmarked`  
Monitoring is inactive.

### Modbus TCP active

Activates/deactivates the monitoring of the *Modbus TCP* function.

Possible values:

- ▶ `marked` (default setting)  
Monitoring is active.  
If you enable the *Modbus TCP* function, then in the *Security status* frame, the value changes to *error*.
- ▶ `unmarked`  
Monitoring is inactive.

You enable/disable the *Modbus TCP* function in the *Advanced > Industrial Protocols > Modbus TCP* dialog, *Operation* frame.

### EtherNet/IP active

Activates/deactivates the monitoring of the *EtherNet/IP* function.

Possible values:

- ▶ `marked` (default setting)  
Monitoring is active.  
If you enable the *EtherNet/IP* function, then in the *Security status* frame, the value changes to *error*.
- ▶ `unmarked`  
Monitoring is inactive.

You enable/disable the *EtherNet/IP* function in the *Advanced > Industrial Protocols > EtherNet/IP* dialog, *Operation* frame.

### PROFINET active

Activates/deactivates the monitoring of the *PROFINET* function.

Possible values:

- ▶ `marked` (default setting)  
Monitoring is active.  
If you enable the *PROFINET* function, then in the *Security status* frame, the value changes to *error*.
- ▶ `unmarked`  
Monitoring is inactive.

You enable/disable the *PROFINET* function in the *Advanced > Industrial Protocols > PROFINET* dialog, *Operation* frame.

## Buttons

You find the description of the standard buttons in section “Buttons” on page 14.

## [Port]

### Table

Port

Displays the port number.

Link interrupted on enabled device ports

Activates/deactivates the monitoring of the link on the active ports.

Possible values:

- ▶ `marked`  
Monitoring is active.  
If the port is enabled (*Basic Settings > Port* dialog, *Configuration* tab, *Port on* checkbox is `marked`) and the link is down on the port, then in the *Security status* frame, the value changes to `error`.
- ▶ `unmarked` (default setting)  
Monitoring is inactive.

This setting takes effect when you mark the *Link interrupted on enabled device ports* checkbox in the *Diagnostics > Status Configuration > Security Status* dialog, *Global* tab.

## Buttons

You find the description of the standard buttons in section “Buttons” on page 14.

## [Status]

### Table

Timestamp

Displays the date and time of the event in the format, `Month Day, Year hh:mm:ss AM/PM`.

Cause

Displays the event which caused the SNMP trap.

## Buttons

You find the description of the standard buttons in section [“Buttons” on page 14](#).

### 6.1.3 Signal Contact

[Diagnostics > Status Configuration > Signal Contact]

The signal contact is a potential-free relay contact. The device thus lets you perform remote diagnosis. The device uses the relay contact to signal the occurrence of events by opening the relay contact and interrupting the closed circuit.

**Note:** The device can contain several signal contacts. Each contact contains the same monitoring functions. Several contacts allow you to group various functions together providing flexibility in system monitoring.

The menu contains the following dialogs:

- ▶ [Signal Contact 1 / Signal Contact 2](#)

## 6.1.3.1 Signal Contact 1 / Signal Contact 2

[Diagnostics > Status Configuration > Signal Contact > Signal Contact 1]

In this dialog you specify the trigger conditions for the signal contact.

The signal contact gives you the following options:

- ▶ Monitoring the correct operation of the device.
- ▶ Signaling the device status of the device.
- ▶ Signaling the security status of the device.
- ▶ Controlling external devices by manually setting the signal contacts.

The device displays detected faults in the [Status](#) tab and also in the [Basic Settings > System](#) dialog, [Signal contact status](#) frame.

The dialog contains the following tabs:

- ▶ [\[Global\]](#)
- ▶ [\[Port\]](#)
- ▶ [\[Status\]](#)

### [Global]

#### Configuration

Mode

Specifies which events the signal contact indicates.

Possible values:

- ▶ [Manual setting](#) (default setting for [Signal Contact 2](#), if present)  
You use this setting to manually open or close the signal contact, for example to turn on or off a remote device. See the [Contact](#) option list.
- ▶ [Monitoring correct operation](#) (default setting)  
Using this setting the signal contact indicates the status of the parameters specified in the table below.
- ▶ [Device status](#)  
Using this setting the signal contact indicates the status of the parameters monitored in the [Diagnostics > Status Configuration > Device Status](#) dialog. In addition, you can read the status in the [Signal contact status](#) frame.
- ▶ [Security status](#)  
Using this setting the signal contact indicates the status of the parameters monitored in the [Diagnostics > Status Configuration > Security Status](#) dialog. In addition, you can read the status in the [Signal contact status](#) frame.
- ▶ [Device/Security status](#)  
Using this setting the signal contact indicates the status of the parameters monitored in the [Diagnostics > Status Configuration > Device Status](#) and the [Diagnostics > Status Configuration > Security Status](#) dialog. In addition, you can read the status in the [Signal contact status](#) frame.



### Contact

Toggles the signal contact manually. The prerequisite is that in the *Mode* drop-down list you select the *Manual setting* item.

Possible values:

- ▶ *open*  
The signal contact is opened.
- ▶ *close*  
The signal contact is closed.

### Signal contact status

#### Signal contact status

Displays the current status of the signal contact.

Possible values:

- ▶ *Opened (error)*  
The signal contact is opened. The circuit is interrupted.
- ▶ *Closed (ok)*  
The signal contact is closed. The circuit is closed.

### Trap configuration

#### Send trap

Activates/deactivates the sending of SNMP traps when the device detects changes in the monitored functions.

Possible values:

- ▶ *marked*  
The sending of SNMP traps is active.  
If the device detects a change in the monitored functions, then the device sends an SNMP trap.
- ▶ *unmarked* (default setting)  
The sending of SNMP traps is inactive.

The prerequisite for sending SNMP traps is that you enable the function in the *Diagnostics > Status Configuration > Alarms (Traps)* dialog and specify at least one trap destination.

## Monitoring correct operation

In the table you specify the parameters that the device monitors. The device signals the occurrence of an event by opening the signal contact.

### Connection errors

Activates/deactivates the monitoring of the link status of the port/interface.

Possible values:

- ▶ **marked**  
Monitoring is active.  
If the link interrupts on a monitored port/interface, then the signal contact opens.  
In the *Port* tab, you have the option of selecting the ports/interfaces to be monitored individually.
- ▶ **unmarked** (default setting)  
Monitoring is inactive.

### Temperature

Activates/deactivates the monitoring of the temperature in the device.

Possible values:

- ▶ **marked** (default setting)  
Monitoring is active.  
If the temperature exceeds / falls below the threshold values, then the signal contact opens.
- ▶ **unmarked**  
Monitoring is inactive.

You specify the temperature thresholds in the *Basic Settings > System* dialog, *Upper temp. limit [°C]* field and *Lower temp. limit [°C]* field.

### Ring redundancy

Activates/deactivates the monitoring of the ring redundancy.

Possible values:

- ▶ **marked**  
Monitoring is active.  
The signal contact opens in the following situations:
  - The redundancy function becomes active (loss of redundancy reserve).
  - The device is a normal ring participant and detects an error in its settings.
- ▶ **unmarked** (default setting)  
Monitoring is inactive.

### Ethernet module removal

Activates/deactivates the monitoring of the modules.

Possible values:

- ▶ **marked**  
Monitoring is active.  
If you remove a module from the device, then the signal contact opens.  
Further down, you have the option of selecting the modules to be monitored individually.
- ▶ **unmarked** (default setting)  
Monitoring is inactive.

### External memory removed

Activates/deactivates the monitoring of the active external memory.

Possible values:

- ▶ `marked`  
Monitoring is active.  
If you remove the active external memory from the device, then the signal contact opens.
- ▶ `unmarked` (default setting)  
Monitoring is inactive.

You specify the active external memory in the [Basic Settings > Load/Save](#) dialog, [External memory](#) frame.

### External memory not in sync with NVM

Activates/deactivates the monitoring of the configuration profile in the device and in the external memory.

Possible values:

- ▶ `marked`  
Monitoring is active.  
The signal contact opens in the following situations:
  - The configuration profile only exists in the device.
  - The configuration profile in the device differs from the configuration profile in the external memory.
- ▶ `unmarked` (default setting)  
Monitoring is inactive.

### Power supply

Activates/deactivates the monitoring of the power supply unit.

Possible values:

- ▶ `marked` (default setting)  
Monitoring is active.  
If the device has a detected power supply fault, then the signal contact opens.
- ▶ `unmarked`  
Monitoring is inactive.

### Module

Activates/deactivates the monitoring of this module.

Possible values:

- ▶ `marked`  
Monitoring is active.  
If you remove this module from the device, then the signal contact opens.
- ▶ `unmarked` (default setting)  
Monitoring is inactive.

This setting is effective when you mark the [Ethernet module removal](#) checkbox further up.

## Buttons

You find the description of the standard buttons in section [“Buttons” on page 14](#).

### [Port]

#### Table

Port

Displays the port number.

Propagate connection error

Activates/deactivates the monitoring of the link on the port/interface.

Possible values:

- ▶ `marked`  
Monitoring is active.  
If the link interrupts on the selected port/interface, then the signal contact opens.
- ▶ `unmarked` (default setting)  
Monitoring is inactive.

This setting takes effect when you mark the *Connection errors* checkbox in the *Global* tab.

## Buttons

You find the description of the standard buttons in section [“Buttons” on page 14](#).

### [Status]

#### Table

Timestamp

Displays the date and time of the event in the format, `Month Day, Year hh:mm:ss AM/PM`.

Cause

Displays the event which caused the SNMP trap.

## Buttons

You find the description of the standard buttons in section [“Buttons” on page 14](#).

## 6.1.4 MAC Notification

[Diagnostics > Status Configuration > MAC Notification]

The device lets you track changes in the network using the MAC address of the devices in the network. The device saves the combination of port and MAC address in its MAC address table. If the device (un)learns the MAC address of a (dis)connected device, then the device sends an SNMP trap.

This function is intended for ports to which you connect end devices and thus the MAC address changes infrequently.

### Operation

Operation

Enables/disables the *MAC Notification* function in the device.

Possible values:

- ▶ *On*  
The *MAC Notification* function is enabled.
- ▶ *OFF* (default setting)  
The *MAC Notification* function is disabled.

### Configuration

Interval [s]

Specifies the send interval in seconds. If the device (un)learns the MAC address of a (dis)connected device, then the device sends an SNMP trap after this time.

Possible values:

- ▶ *0..2147483647* (default setting: 30)

Before sending an SNMP trap, the device registers up to 20 MAC addresses. If the device detects a high number of changes, then the device sends the SNMP trap before the send interval expires.

### Table

Port

Displays the port number.

## Active

Activates/deactivates the *MAC Notification* function on the port.

Possible values:

▶ *marked*

The *MAC Notification* function is active on the port.

The device sends an SNMP trap in case of one of the following events:

- The device learns the MAC address of a newly connected device.
- The device unlearns the MAC address of a disconnected device.

▶ *unmarked* (default setting)

The *MAC Notification* function is inactive on the port.

The prerequisite for sending SNMP traps is that you enable the function in the *Diagnostics > Status Configuration > Alarms (Traps)* dialog and specify at least one trap destination.

## Last MAC address

Displays the MAC address of the device last connected on or disconnected from the port.

The device detects the MAC addresses of devices which are connected as follows:

- directly connected to the port
- connected to the port through other devices in the network

## Last MAC status

Displays the status of the *Last MAC address* value on this port.

Possible values:

▶ *added*

The device detected that another device was connected at the port.

▶ *removed*

The device detected that the connected device was removed from the port.

▶ *other*

The device did not detect a status.

**Buttons**

You find the description of the standard buttons in section “Buttons” on page 14.

## 6.1.5 Alarms (Traps)

[Diagnostics > Status Configuration > Alarms (Traps)]

The device lets you send an SNMP trap as a reaction to specific events. In this dialog you specify the trap destinations to which the device sends the SNMP traps.

The events for which the device triggers an SNMP trap, you specify, for example, in the following dialogs:

- ▶ in the [Diagnostics > Status Configuration > Device Status](#) dialog
- ▶ in the [Diagnostics > Status Configuration > Security Status](#) dialog
- ▶ in the [Diagnostics > Status Configuration > MAC Notification](#) dialog

### Operation

Operation

Enables/disables the sending of SNMP traps to the trap destinations.

Possible values:

- ▶ *On* (default setting)  
The sending of SNMP traps is enabled.
- ▶ *Off*  
The sending of SNMP traps is disabled.

### Table

Name

Specifies the name of the trap destination.

Possible values:

- ▶ Alphanumeric ASCII character string with 1..32 characters

Address

Specifies the IP address and the port number of the trap destination.

Possible values:

- ▶ `<Valid IPv4 address>:<port number>`

Active

Activates/deactivates the sending of SNMP traps to this trap destination.

Possible values:

- ▶ *marked* (default setting)  
The sending of SNMP traps to this trap destination is active.
- ▶ *unmarked*  
The sending of SNMP traps to this trap destination is inactive.

## Buttons

You find the description of the standard buttons in section [“Buttons” on page 14](#).



Opens the [Create](#) window to add a new entry to the table.

- ▶ In the [Name](#) field you specify a name for the trap destination.
- ▶ In the [Address](#) field you specify the IP address and the port number of the trap destination. If you choose not to enter a port number, then the device automatically adds the port number [162](#).



## 6.2 System

[Diagnostics > System]

The menu contains the following dialogs:

- ▶ System Information
- ▶ Hardware State
- ▶ Configuration Check
- ▶ IP Address Conflict Detection
- ▶ ARP
- ▶ Selftest

## 6.2.1 System Information

[Diagnostics > System > System Information]

This dialog displays the current operating condition of individual components in the device. The displayed values are a snapshot; they represent the operating condition at the time the dialog was loaded to the page.

### Buttons

You find the description of the standard buttons in section [“Buttons” on page 14](#).

#### Save system information

Opens the HTML page in a new web browser window or tab. You can save the HTML page on your PC using the appropriate web browser command.

## 6.2.2 Hardware State

[Diagnostics > System > Hardware State]

This dialog provides information about the distribution and state of the flash memory of the device.

### Information

Uptime

Displays the total operating time of the device since it was delivered.

Possible values:

▶ `..d ..h ..m ..s`  
Day(s) Hour(s) Minute(s) Second(s)

### Table

Flash region

Displays the name of the respective memory area.

Description

Displays a description of what the device uses the memory area for.

Flash sectors

Displays how many sectors are assigned to the memory area.

Sector erase operations

Displays how many times the device has overwritten the sectors of the memory area.

### Buttons

You find the description of the standard buttons in section [“Buttons” on page 14](#).

## 6.2.3 Configuration Check

[Diagnostics > System > Configuration Check]

The device lets you compare the settings in the device with the settings in its neighboring devices. For this purpose, the device uses the information that it received from its neighboring devices through topology recognition (LLDP).

The dialog lists the deviations detected, which affect the performance of the communication between the device and the recognized neighboring devices.

You update the content of the table by clicking the  button. When the table remains empty, the configuration check was successful and the settings in the device are compatible with the settings in the detected neighboring devices.

If you have set up more than 39 VLANs in the device, then the dialog constantly displays a warning. The reason is the limited number of possible VLAN data sets in LLDP packets with a maximum length. The device compares the first 39 VLANs automatically. If you have set up 40 or more VLANs in the device, then check the congruence of the further VLANs manually, if necessary.

**Note:** A neighboring device without LLDP support, which forwards LLDP packets, can be the cause of equivocal messages in the dialog. This occurs if the neighboring device is a hub or a switch without management, which ignores the IEEE 802.1D-2004 standard. In this case, the dialog displays the devices recognized and connected to the neighboring device as connected to the device itself, even though they are connected to the neighboring device.

### Summary

You also find this information when you position the mouse pointer over the  button in the Toolbar in the top part of the Navigation area.

#### Error

Displays the number of errors that the device detected during the configuration check.

#### Warning

Displays the number of warnings that the device detected during the configuration check.

#### Information

Displays the amount of information that the device detected during the configuration check.

### Table

When you highlight a row in the table, the device displays additional information in the area beneath it.

#### ID

Displays the rule ID of the deviations having occurred. The dialog combines several deviations with the same rule ID under one rule ID.

### Level

Displays the level of deviation between the settings in this device and the settings in the detected neighboring devices.

The device differentiates between the following access statuses:

- ▶ [INFORMATION](#)  
The performance of the communication between the two devices is not impaired.
- ▶ [WARNING](#)  
The performance of the communication between the two devices is possibly impaired.
- ▶ [ERROR](#)  
The communication between the two devices is impaired.

### Message

Displays the information, warnings and errors having occurred more precisely.

### Buttons

You find the description of the standard buttons in section [“Buttons” on page 14](#).

## 6.2.4 IP Address Conflict Detection

[Diagnostics > System > IP Address Conflict Detection]

Using the *IP Address Conflict Detection* function the device verifies that its IP address is unique in the network. For this purpose, the device analyzes received ARP packets.

In this dialog you specify the procedure with which the device detects address conflicts and specify the required settings for this.

The device displays detected address conflicts in the table.

When the device detects an address conflict, the status LED of the device flashes red 4 times.

### Operation

#### Operation

Enables/disables the *IP Address Conflict Detection* function.

Possible values:

- ▶ *On* (default setting)  
The *IP Address Conflict Detection* function is enabled.  
The device verifies that its IP address is unique in the network.
- ▶ *Off*  
The *IP Address Conflict Detection* function is disabled.

### Configuration

#### Detection mode

Specifies the procedure with which the device detects address conflicts.

Possible values:

- ▶ *active and passive* (default setting)  
The device uses active and passive address conflict detection.
- ▶ *active*  
Active address conflict detection. The device actively helps avoid communicating with an IP address that already exists in the network. The address conflict detection begins as soon as you connect the device to the network or change its IP parameters.
  - The device sends 4 ARP probe data packets at the interval specified in the *Detection delay [ms]* field. If the device receives a response to these data packets, then there is an address conflict.
  - If the device does not detect an address conflict, then it sends 2 gratuitous ARP data packets as an announcement. The device also sends these data packets when the address conflict detection is disabled.
  - If the IP address already exists in the network, then the device changes back to the previously used IP parameters (if possible).  
If the device receives its IP parameters from a DHCP server, then it sends a DHCPDECLINE message back to the DHCP server.

- After the period specified in the *Release delay [s]* field, the device checks if the address conflict still exists. When the device detects 10 address conflicts one after the other, the device extends the waiting time to 60 s for the next check.
  - When the device resolves the address conflict, the device management returns to the network again.
- ▶ *passive*
- Passive address conflict detection. The device analyzes the data traffic in the network. If another device in the network is using the same IP address, then the device initially “defends” its IP address. The device stops sending if the other device keeps sending with the same IP address.
- As a “defence” the device sends gratuitous ARP data packets. The device repeats this procedure for the number of times specified in the *Address protections* field.
  - If the other device continues sending with the same IP address, then after the period specified in the *Release delay [s]* field, the device periodically checks if the address conflict still exists.
  - When the device resolves the address conflict, the device management returns to the network again.

#### Send periodic ARP probes

Activates/deactivates the periodic address conflict detection.

Possible values:

- ▶ *marked* (default setting)
- The periodic address conflict detection is active.
- The device periodically sends an ARP probe data packet every 90 to 150 seconds and waits for the time specified in the *Detection delay [ms]* field for a response.
  - If the device detects an address conflict, then the device applies the passive detection mode function. If the *Send trap* function is active, then the device sends an SNMP trap.
- ▶ *unmarked*
- The periodic address conflict detection is inactive.

## Detection delay [ms]

Specifies the period in milliseconds for which the device waits for a response after sending a ARP data packets.

Possible values:

- ▶ 20..500 (default setting: 200)

## Release delay [s]

Specifies the period in seconds after which the device checks again if the address conflict still exists.

Possible values:

- ▶ 3..3600 (default setting: 15)

## Address protections

Specifies how many times the device sends gratuitous ARP data packets in the passive detection mode to “defend” its IP address.

Possible values:

- ▶ 0..100 (default setting: 3)

## Protection interval [ms]

Specifies the period in milliseconds after which the device sends gratuitous ARP data packets again in the passive detection mode to “defend” its IP address.

Possible values:

- ▶ 20..5000 (default setting: 200)

## Send trap

Activates/deactivates the sending of SNMP traps when the device detects address conflicts.

Possible values:

- ▶ `marked`  
The sending of SNMP traps is active.  
If the device detects an address conflict, then the device sends an SNMP trap.
- ▶ `unmarked` (default setting)  
The sending of SNMP traps is inactive.

The prerequisite for sending SNMP traps is that you enable the function in the [Diagnostics > Status Configuration > Alarms \(Traps\)](#) dialog and specify at least one trap destination.



## Information

### Conflict detected

Displays if an address conflict currently exists.

Possible values:

- ▶ `marked`  
The device detects an address conflict.
- ▶ `unmarked`  
The device does not detect an address conflict.

## Table

### Timestamp

Displays the time at which the device detected an address conflict.

### Port

Displays the number of the port on which the device detected the address conflict.

### IP address

Displays the IP address that is causing the address conflict.

### MAC address

Displays the MAC address of the device with which the address conflict exists.

## Buttons

You find the description of the standard buttons in section [“Buttons” on page 14](#).

## 6.2.5 ARP

[Diagnostics > System > ARP]

This dialog displays the MAC and IP addresses of the neighboring devices connected to the device management.

### Table

Port

Displays the port number.

IP address

Displays the IPv4 address of a neighboring device.

MAC address

Displays the MAC address of a neighboring device.

Last updated

Displays the time in seconds since the current settings of the entry were registered in the ARP table.

Type

Displays the type of the entry.

Possible values:

- ▶ `static`  
Static entry. When the ARP table is deleted, the device keeps the static entry.
- ▶ `dynamic`  
Dynamic entry. When the *Aging time [s]* has been exceeded and the device does not receive any data from this device during this time, the device deletes the dynamic entry.
- ▶ `local`  
IP and MAC address of the device management.

Active

Displays that the ARP table contains the IP/MAC address assignment as an active entry.

### Buttons

You find the description of the standard buttons in section [“Buttons” on page 14](#).

Reset ARP table

Removes the dynamically set up addresses from the ARP table.

## 6.2.6 Selftest

[Diagnostics > System > Selftest]

This dialog lets you do the following:

- ▶ Activate/deactivate the RAM test when the device is being started.
- ▶ Enable/disable the option of entering the system monitor upon the system start.
- ▶ Specify how the device behaves in the case of an error.

### Configuration

If the device does not detect any readable configuration profile when restarting, then the following settings block your access to the device permanently.

- ▶ *SysMon1 is available* checkbox is *unmarked*.
- ▶ *Load default config on error* checkbox is *unmarked*.

This is the case, for example, if the password of the configuration profile that you are loading differs from the password set in the device. To have the device unlocked again, contact your sales partner.

#### RAM test

Activates/deactivates the RAM memory check during the restart.

Possible values:

- ▶ *marked* (default setting)  
The RAM memory check is activated. During the restart, the device checks the RAM memory.
- ▶ *unmarked*  
The RAM memory check is deactivated. This shortens the start time for the device.

#### SysMon1 is available

Activates/deactivates the access to the system monitor during the restart.

Possible values:

- ▶ *marked* (default setting)  
The device lets you open the system monitor during the restart.
- ▶ *unmarked*  
The device starts without the option of opening to the system monitor.

Among other things, the system monitor lets you update the device software and to delete saved configuration profiles.

### Load default config on error

Activates/deactivates the loading of the default settings if the device does not detect any readable configuration profile when restarting.

Possible values:

- ▶ `marked` (default setting)  
The device loads the default settings.
- ▶ `unmarked`  
The device interrupts the restart and stops. The access to the device management is possible only using the Command Line Interface through the serial interface.  
To regain the access to the device through the network, open the system monitor and reset the settings. Upon restart, the device loads the default settings.

### Table

In this table you specify how the device behaves in the case of an error.

#### Cause

Error causes to which the device reacts.

Possible values:

- ▶ `task`  
The device detects errors in the applications executed, for example if a task terminates or is not available.
- ▶ `resource`  
The device detects errors in the resources available, for example if the memory is becoming scarce.
- ▶ `software`  
The device detects software errors, for example error in the consistency check.
- ▶ `hardware`  
The device detects hardware errors, for example in the chip set.

#### Action

Specifies how the device behaves if the adjacent event occurs.

Possible values:

- ▶ `reboot` (default setting)  
The device triggers a restart.
- ▶ `logOnly`  
The device registers the detected error in the log file. See the [Diagnostics > Report > System Log](#) dialog.
- ▶ `sendTrap`  
The device sends an SNMP trap.  
The prerequisite for sending SNMP traps is that you enable the function in the [Diagnostics > Status Configuration > Alarms \(Traps\)](#) dialog and specify at least one trap destination.

## **Buttons**

You find the description of the standard buttons in section [“Buttons” on page 14](#).

## 6.3 Syslog

[Diagnostics > Syslog]

The device lets you report selected events, independent of the severity of the event, to different syslog servers. In this dialog you specify the settings for this function and manage up to 8 syslog servers.

### Operation

Operation

Enables/disables the sending of events to the syslog servers.

Possible values:

- ▶ *On*  
The sending of events is enabled.  
The device sends the events specified in the table to the specified syslog servers.
- ▶ *Off* (default setting)  
The sending of events is disabled.

### Table

Index

Displays the index number to which the table entry relates.

When you delete a table entry, this leaves a gap in the numbering. When you create a new table entry, the device fills the first gap.

Possible values:

- ▶ 1..8

#### IP address

Specifies the IP address of the syslog server.

Possible values:

- ▶ Valid IPv4 address (default setting: 0.0.0.0)

#### Destination UDP port

Specifies the UDP port on which the syslog server expects the log entries.

Possible values:

- ▶ 1..65535 (default setting: 514)

#### Transport type

Displays the transport type the device uses to send the events to the syslog server.

Possible values:

- ▶ udp  
The device sends the events over the UDP port specified in the *Destination UDP port* column.

#### Min. severity

Specifies the minimum severity of the events. The device sends a log entry for events with this severity and with more urgent severities to the syslog server.

Possible values:

- ▶ emergency
- ▶ alert
- ▶ critical
- ▶ error
- ▶ warning (default setting)
- ▶ notice
- ▶ informational
- ▶ debug

#### Type

Specifies the type of the log entry transmitted by the device.

Possible values:

- ▶ systemlog (default setting)
- ▶ audittrail

## Active

Activates/deactivates the transmission of events to the syslog server:

- ▶ `marked`  
The device sends events to the syslog server.
- ▶ `unmarked` (default setting)  
The transmission of events to the syslog server is deactivated.

## Buttons

You find the description of the standard buttons in section [“Buttons” on page 14](#).



## 6.4 Ports

[Diagnostics > Ports]

The menu contains the following dialogs:

- ▶ SFP
- ▶ TP cable diagnosis
- ▶ Port Monitor
- ▶ Auto-Disable
- ▶ Port Mirroring

## 6.4.1 SFP

[Diagnostics > Ports > SFP]

This dialog lets you look at the SFP transceivers currently connected to the device and their properties.

### Table

The table displays valid values if the device is equipped with SFP transceivers.

Port

Displays the port number.

Module type

Type of the SFP transceiver, for example M-SFP-SX/LC.

Serial number

Displays the serial number of the SFP transceiver.

Connector type

Displays the connector type.

Supported

Displays if the device supports the SFP transceiver.

Temperature [°C]

Operating temperature of the SFP transceiver in °Celsius.

Tx power [mW]

Transmission power of the SFP transceiver in mW.

Rx power [mW]

Receiving power of the SFP transceiver in mW.

Tx power [dBm]

Transmission power of the SFP transceiver in dBm.

Rx power [dBm]

Receiving power of the SFP transceiver in dBm.

## **Buttons**

You find the description of the standard buttons in section [“Buttons” on page 14](#).

## 6.4.2 TP cable diagnosis

[Diagnostics > Ports > TP cable diagnosis]

This feature tests the cable attached to an interface for short or open circuit. The table displays the cable status and estimated length. The device also displays the individual cable pairs connected to the port. When the device detects a short circuit or an open circuit in the cable, it also displays the estimated distance to the problem.

**Note:** This test interrupts traffic on the port.

### Information

Port

Displays the port number.

Status

Status of the Virtual Cable Tester.

Possible values:

- ▶ *active*  
Cable testing is in progress.  
To start the test, click the  button and then the *Start cable diagnosis...* item. This action opens the *Select port* dialog.
- ▶ *success*  
The device displays this entry after performing a successful test.
- ▶ *failure*  
The device displays this entry after an interruption in the test.
- ▶ *uninitialized*  
The device displays this entry while in standby.

### Table

Cable pair

Displays the cable pair to which this entry relates. The device uses the first PHY index supported to display the values.

Result

Displays the results of the cable test.

Possible values:

- ▶ *normal*  
The cable is functioning properly.
- ▶ *open*  
There is a break in the cable causing an interruption.

▶ *short*

Wires in the cable are touching together causing a short circuit.

▶ *unknown*

The device displays this value for untested cable pairs.

The device displays different values than expected in the following cases:

- If no cable is connected to the port, then the device displays the value *unknown* instead of *open*.
- If the port is deactivated, then the device displays the value *short*.

### Min. length

Displays the minimum estimated length of the cable in meters.

If the cable length is unknown or in the *Information* frame the *Status* field displays the value *active*, *failure* or *uninitialized*, then the device displays the value 0.

### Max. length

Displays the maximum estimated length of the cable in meters.

If the cable length is unknown or in the *Information* frame the *Status* field displays the value *active*, *failure* or *uninitialized*, then the device displays the value 0.

### Distance [m]

Displays the estimated distance in meters from the end of the cable to the failure location.

If the cable length is unknown or in the *Information* frame the *Status* field displays the value *active*, *failure* or *uninitialized*, then the device displays the value 0.

## Buttons

You find the description of the standard buttons in section “Buttons” on page 14.

### Start cable diagnosis...

Opens the *Select port* dialog.

In the *Port* drop-down list you select the port to be tested. Use for copper-based ports only.

To initiate the cable test on the selected port, click the *Ok* button.

## 6.4.3 Port Monitor

[Diagnostics > Ports > Port Monitor]

The *Port Monitor* function monitors the adherence to the specified parameters on the ports. If the *Port Monitor* function detects that the parameters are being exceeded, then the device performs an action.

To apply the *Port Monitor* function, perform the following steps:

- ▶ *Global* tab
  - Enable the *Operation* function in the *Port Monitor* frame.
  - Activate for each port those parameters that you want the *Port Monitor* function to monitor.
- ▶ *Link flap*, *CRC/Fragments* and *Overload detection* tabs
  - Specify the threshold values for the parameters for each port.
- ▶ *Link speed/Duplex mode detection* tab
  - Activate the allowed combinations of speed and duplex mode for each port.
- ▶ *Global* tab
  - Specify for each port an action that the device carries out if the *Port Monitor* function detects that the parameters have been exceeded.
- ▶ *Auto-disable* tab
  - Mark the *Auto-disable* checkbox for the monitored parameters if you have specified the *auto-disable* action at least once.

The dialog contains the following tabs:

- ▶ [Global]
- ▶ [Auto-disable]
- ▶ [Link flap]
- ▶ [CRC/Fragments]
- ▶ [Overload detection]
- ▶ [Link speed/Duplex mode detection]

### [Global]

In this tab you enable the *Port Monitor* function and specify the parameters that the *Port Monitor* function is monitoring. Also specify the action that the device carries out if the *Port Monitor* function detects that the parameters have been exceeded.

### Operation

#### Operation

Enables/disables the *Port Monitor* function globally.

Possible values:

- ▶ *On*  
The *Port Monitor* function is enabled.
- ▶ *OFF* (default setting)  
The *Port Monitor* function is disabled.

**Table**

## Port

Displays the port number.

## Link flap on

Activates/deactivates the monitoring of link flaps on the port.

Possible values:

- ▶ `marked`  
Monitoring is active.
  - The *Port Monitor* function monitors link flaps on the port.
  - If the device detects too many link flaps, then the device executes the action specified in the *Action* column.
  - On the *Link flap* tab, specify the parameters to be monitored.
- ▶ `unmarked` (default setting)  
Monitoring is inactive.

## CRC/Fragments on

Activates/deactivates the monitoring of CRC/fragment errors on the port.

Possible values:

- ▶ `marked`  
Monitoring is active.
  - The *Port Monitor* function monitors CRC/fragment errors on the port.
  - If the device detects too many CRC/fragment errors, then the device executes the action specified in the *Action* column.
  - On the *CRC/Fragments* tab, specify the parameters to be monitored.
- ▶ `unmarked` (default setting)  
Monitoring is inactive.

## Duplex mismatch detection active

Activates/deactivates the monitoring of duplex mismatches on the port.

Possible values:

- ▶ `marked`  
Monitoring is active.
  - The *Port Monitor* function monitors duplex mismatches on the port.
  - If the device detects a duplex mismatch, then the device executes the action specified in the *Action* column.
- ▶ `unmarked` (default setting)  
Monitoring is inactive.

## Overload detection on

Activates/deactivates the overload detection on the port.

Possible values:

- ▶ `marked`  
Monitoring is active.
  - The *Port Monitor* function monitors the data load on the port.

- If the device detects a data overload on the port, then the device executes the action specified in the *Action* column.
- On the *Overload detection* tab, specify the parameters to be monitored.
- ▶ *unmarked* (default setting)  
Monitoring is inactive.

#### Link speed/Duplex mode detection on

Activates/deactivates the monitoring of the link speed and duplex mode on the port.

Possible values:

- ▶ *marked*  
Monitoring is active.
  - The *Port Monitor* function monitors the link speed and duplex mode on the port.
  - If the device detects an unpermitted combination of link speed and duplex mode, then the device executes the action specified in the *Action* column.
  - On the *Link speed/Duplex mode detection* tab, specify the parameters to be monitored.
- ▶ *unmarked* (default setting)  
Monitoring is inactive.

#### Active condition

Displays the monitored parameter that led to the action on the port.

Possible values:

- ▶ *-*  
No monitored parameter.  
The device does not carry out any action.
- ▶ *Link flap*  
Too many link changes in the observed period.
- ▶ *CRC/Fragments*  
Too many CRC/fragment errors in the observed period.
- ▶ *Duplex mismatch*  
Duplex mismatch detected.
- ▶ *Overload detection*  
Overload detected in the observed period.
- ▶ *Link speed/Duplex mode detection*  
Impermissible combination of speed and duplex mode detected.

#### Action

Specifies the action that the device carries out if the *Port Monitor* function detects that the parameters have been exceeded.

Possible values:

- ▶ *disable port*  
The device disables the port and sends an SNMP trap.  
The “Link status” LED for the port flashes 3× per period.
  - To re-enable the port, highlight the port and click the  button and then the *Reset* item.
  - If the parameters are no longer being exceeded, then the *Auto-Disable* function enables the relevant port again after the specified waiting period. The prerequisite is that on the *Auto-disable* tab the checkbox for the monitored parameter is marked.



- ▶ *send trap*  
The device sends an SNMP trap.  
The prerequisite for sending SNMP traps is that you enable the function in the [Diagnostics > Status Configuration > Alarms \(Traps\)](#) dialog and specify at least one trap destination.
- ▶ *auto-disable* (default setting)  
The device disables the port and sends an SNMP trap.  
The “Link status” LED for the port flashes 3 × per period.  
The prerequisite is that on the [Auto-disable](#) tab the checkbox for the monitored parameter is marked.
  - The [Diagnostics > Ports > Auto-Disable](#) dialog displays which ports are currently disabled due to the parameters being exceeded.
  - The [Auto-Disable](#) function reactivates the port automatically. For this you go to the [Diagnostics > Ports > Auto-Disable](#) dialog and specify a waiting period for the relevant port in the [Reset timer \[s\]](#) column.

#### Port status

Displays the operating state of the port.

Possible values:

- ▶ *up*  
The port is enabled.
- ▶ *down*  
The port is disabled.
- ▶ *notPresent*  
Physical port unavailable.

### Buttons

You find the description of the standard buttons in section “Buttons” on page 14.

#### Reset

Enables the port highlighted in the table again and resets its counter to 0. This affects the counters in the following dialogs:

- ▶ [Diagnostics > Ports > Port Monitor](#) dialog
  - [Link flap](#) tab
  - [CRC/Fragments](#) tab
  - [Overload detection](#) tab
- ▶ [Diagnostics > Ports > Auto-Disable](#) dialog

### [Auto-disable]

In this tab you activate the [Auto-Disable](#) function for the parameters monitored by the [Port Monitor](#) function.

## Table

### Reason

Displays the parameters monitored by the *Port Monitor* function.

Mark the adjacent checkbox so that the *Port Monitor* function carries out the *auto-disable* action if it detects that the monitored parameters have been exceeded.

### Auto-disable

Activates/deactivates the *Auto-Disable* function for the adjacent parameters.

Possible values:

- ▶ *marked*  
The *Auto-Disable* function for the adjacent parameters is active.  
If the adjacent parameters are exceeded and the value *auto-disable* is specified in the *Action* column, then the device carries out the *Auto-Disable* function.
- ▶ *unmarked* (default setting)  
The *Auto-Disable* function for the adjacent parameters is inactive.

## Buttons

You find the description of the standard buttons in section “Buttons” on page 14.

### Reset

Enables the port highlighted in the table again and resets its counter to 0. This affects the counters in the following dialogs:

- ▶ *Diagnosics > Ports > Port Monitor* dialog
  - *Link flap* tab
  - *CRC/Fragments* tab
  - *Overload detection* tab
- ▶ *Diagnosics > Ports > Auto-Disable* dialog

## [Link flap]

In this tab you specify individually for every port the following settings:

- ▶ The number of link changes.
- ▶ The period during which the *Port Monitor* function monitors a parameter to detect discrepancies.

You also see how many link changes the *Port Monitor* function has detected up to now.

The *Port Monitor* function monitors those ports for which the checkbox in the *Link flap on* column is marked on the *Global* tab.

## Table

### Port

Displays the port number.

### Sampling interval [s]

Specifies in seconds, the period during which the *Port Monitor* function monitors a parameter to detect discrepancies.

Possible values:

▶ 1..180 (default setting: 10)

### Link flaps

Specifies the number of link changes.

If the *Port Monitor* function detects this number of link changes in the monitored period, then the device performs the specified action.

Possible values:

▶ 1..100 (default setting: 5)

### Last sampling interval

Displays the number of errors that the device has detected during the period that has elapsed.

### Total

Displays the total number of errors that the device has detected since the port was enabled.

## Buttons

You find the description of the standard buttons in section “Buttons” on page 14.

### Reset

Enables the port highlighted in the table again and resets its counter to 0. This affects the counters in the following dialogs:

- ▶ *Diagnostics > Ports > Port Monitor* dialog
  - *Link flap* tab
  - *CRC/Fragments* tab
  - *Overload detection* tab
- ▶ *Diagnostics > Ports > Auto-Disable* dialog

## [CRC/Fragments]

In this tab you specify individually for every port the following settings:

- ▶ The fragment error rate.
- ▶ The period during which the *Port Monitor* function monitors a parameter to detect discrepancies.

You also see the fragment error rate that the device has detected up to now.

The *Port Monitor* function monitors those ports for which the checkbox in the *CRC/Fragments on* column is marked on the *Global* tab.

## Table

Port

Displays the port number.

Sampling interval [s]

Specifies in seconds, the period during which the *Port Monitor* function monitors a parameter to detect discrepancies.

Possible values:

▶ 5..180 (default setting: 10)

CRC/Fragments count [ppm]

Specifies the fragment error rate (in parts per million).

If the *Port Monitor* function detects this fragment error rate in the monitored period, then the device performs the specified action.

Possible values:

▶ 1..1000000 (default setting: 1000)

Last active interval [ppm]

Displays the fragment error rate that the device has detected during the period that has elapsed.

Total [ppm]

Displays the fragment error rate that the device has detected since the port was enabled.

## Buttons

You find the description of the standard buttons in section “Buttons” on page 14.

Reset

Enables the port highlighted in the table again and resets its counter to 0. This affects the counters in the following dialogs:

- ▶ *Diagnostics > Ports > Port Monitor* dialog
  - *Link flap* tab
  - *CRC/Fragments* tab
  - *Overload detection* tab
- ▶ *Diagnostics > Ports > Auto-Disable* dialog

**[Overload detection]**

In this tab you specify individually for every port the following settings:

- ▶ The load threshold values.
- ▶ The period during which the *Port Monitor* function monitors a parameter to detect discrepancies.

You also see the number of data packets that the device has detected up to now.

The *Port Monitor* function monitors those ports for which the checkbox in the *Overload detection on* column is marked on the *Global* tab.

The *Port Monitor* function does not monitor any ports that are members of a link aggregation group or PRP/HSR subscribers.

**Table**

Port

Displays the port number.

Traffic type

Specifies the type of data packets that the device considers when monitoring the load on the port.

Possible values:

- ▶ *all*  
The *Port Monitor* function monitors Broadcast, Multicast and Unicast packets.
- ▶ *bc* (default setting)  
The *Port Monitor* function monitors only Broadcast packets.
- ▶ *bc-mc*  
The *Port Monitor* function monitors only Broadcast and Multicast packets.

Threshold type

Specifies the unit for the data rate.

Possible values:

- ▶ *pps* (default setting)  
packets per second
- ▶ *kbps*  
kbit per second  
The prerequisite is that the value in the *Traffic type* column = *all*.

Lower threshold

Specifies the lower threshold value for the data rate.

The *Auto-Disable* function enables the port again only when the load on the port is lower than the value specified here.

Possible values:

▶ 0..10000000 (default setting: 0)

#### Upper threshold

Specifies the upper threshold value for the data rate.

If the *Port Monitor* function detects this load in the monitored period, then the device performs the specified action.

Possible values:

▶ 0..10000000 (default setting: 0)

#### Interval [s]

Specifies in seconds, the period that the *Port Monitor* function observes a parameter to detect that a parameter is being exceeded.

Possible values:

▶ 1..20 (default setting: 1)

#### Packets

Displays the number of Broadcast, Multicast and Unicast packets that the device has detected during the period that has elapsed.

#### Broadcast packets

Displays the number of Broadcast packets that the device has detected during the period that has elapsed.

#### Multicast packets

Displays the number of Multicast packets that the device has detected during the period that has elapsed.

#### Kbit/s

Displays the data rate in Kbits per second that the device has detected during the period that has elapsed.

## Buttons

You find the description of the standard buttons in section [“Buttons” on page 14](#).

#### Reset

Enables the port highlighted in the table again and resets its counter to 0. This affects the counters in the following dialogs:

- ▶ *Diagnostics > Ports > Port Monitor* dialog
  - *Link flap* tab
  - *CRC/Fragments* tab
  - *Overload detection* tab
- ▶ *Diagnostics > Ports > Auto-Disable* dialog

**[Link speed/Duplex mode detection]**

In this tab you activate the allowed combinations of speed and duplex mode for each port.

The *Port Monitor* function monitors those ports for which the checkbox in the *Link speed/Duplex mode detection on* column is marked on the *Global* tab.

The *Port Monitor* function monitors only enabled physical ports.

**Table**

Port

Displays the port number.

10 Mbit/s HDX

Activates/deactivates the port monitor to accept a half-duplex and 10 Mbit/s data rate combination on the port.

Possible values:

- ▶ *marked*  
The port monitor takes into consideration the speed and duplex combination.
- ▶ *unmarked*  
If the port monitor detects the speed and duplex combination on the port, then the device executes the action specified in the *Global* tab.

10 Mbit/s FDX

Activates/deactivates the port monitor to accept a full-duplex and 10 Mbit/s data rate combination on the port.

Possible values:

- ▶ *marked*  
The port monitor takes into consideration the speed and duplex combination.
- ▶ *unmarked*  
If the port monitor detects the speed and duplex combination on the port, then the device executes the action specified in the *Global* tab.

100 Mbit/s HDX

Activates/deactivates the port monitor to accept a half-duplex and 100 Mbit/s data rate combination on the port.

Possible values:

- ▶ *marked*  
The port monitor takes into consideration the speed and duplex combination.
- ▶ *unmarked*  
If the port monitor detects the speed and duplex combination on the port, then the device executes the action specified in the *Global* tab.

#### 100 Mbit/s FDX

Activates/deactivates the port monitor to accept a full-duplex and 100 Mbit/s data rate combination on the port.

Possible values:

- ▶ [marked](#)  
The port monitor takes into consideration the speed and duplex combination.
- ▶ [unmarked](#)  
If the port monitor detects the speed and duplex combination on the port, then the device executes the action specified in the [Global](#) tab.

#### 1,000 Mbit/s FDX

Activates/deactivates the port monitor to accept a full-duplex and 1 Gbit/s data rate combination on the port.

Possible values:

- ▶ [marked](#)  
The port monitor takes into consideration the speed and duplex combination.
- ▶ [unmarked](#)  
If the port monitor detects the speed and duplex combination on the port, then the device executes the action specified in the [Global](#) tab.

### Buttons

You find the description of the standard buttons in section [“Buttons” on page 14](#).

#### Reset

Enables the port highlighted in the table again and resets its counter to 0. This affects the counters in the following dialogs:

- ▶ [Diagnostics > Ports > Port Monitor](#) dialog
  - [Link flap](#) tab
  - [CRC/Fragments](#) tab
  - [Overload detection](#) tab
- ▶ [Diagnostics > Ports > Auto-Disable](#) dialog



## 6.4.4 Auto-Disable

[Diagnostics > Ports > Auto-Disable]

The *Auto-Disable* function lets you disable monitored ports automatically and enable them again as you desire.

For example, the *Port Monitor* function and selected functions in the *Network Security* menu use the *Auto-Disable* function to disable ports if monitored parameters are exceeded.

If the parameters are no longer being exceeded, then the *Auto-Disable* function enables the relevant port again after the specified waiting period.

The dialog contains the following tabs:

- ▶ [Port]
- ▶ [Status]

### [Port]

This tab displays which ports are currently disabled due to the parameters being exceeded. If the parameters are no longer being exceeded and you specify a waiting period in the *Reset timer [s]* column, then the *Auto-Disable* function automatically enables the relevant port again.

#### Table

Port

Displays the port number.

Reset timer [s]

Specifies the waiting period in seconds, after which the *Auto-Disable* function enables the port again.

Possible values:

- ▶ 0 (default setting)  
The timer is inactive. The port remains disabled.
- ▶ 30..4294967295  
If the parameters are no longer being exceeded, then the *Auto-Disable* function enables the port again after the waiting period specified here.

Error time

Displays when the device disabled the port due to the parameters being exceeded.

Remaining time [s]

Displays the remaining time in seconds, until the *Auto-Disable* function enables the port again.

### Component

Displays the software component in the device that disabled the port.

Possible values:

- ▶ `PORT_MON`  
*Port Monitor*  
See the [Diagnostics > Ports > Port Monitor](#) dialog.
- ▶ `PORT_ML`  
*Port Security*  
See the [Network Security > Port Security](#) dialog.
- ▶ `DOT1S`  
*BPDU guard*  
See the [Switching > L2-Redundancy > Spanning Tree > Global](#) dialog.

### Reason

Displays the monitored parameter that led to the port being disabled.

Possible values:

- ▶ `none`  
No monitored parameter.  
The port is enabled.
- ▶ `link-flap`  
Too many link changes. See the [Diagnostics > Ports > Port Monitor](#) dialog, [Link flap](#) tab.
- ▶ `crc-error`  
Too many CRC/fragment errors. See the [Diagnostics > Ports > Port Monitor](#) dialog, [CRC/Fragments](#) tab.
- ▶ `duplex-mismatch`  
Duplex mismatch detected. See the [Diagnostics > Ports > Port Monitor](#) dialog, [Global](#) tab.
- ▶ `bpdur-rate`  
STP-BPDUs received. See the [Switching > L2-Redundancy > Spanning Tree > Global](#) dialog.
- ▶ `mac-based-port-security`  
Too many data packets from undesired senders. See the [Network Security > Port Security](#) dialog.
- ▶ `overload-detection`  
Overload. See the [Diagnostics > Ports > Port Monitor](#) dialog, [Overload detection](#) tab.
- ▶ `speed-duplex`  
Impermissible combination of speed and duplex mode detected. See the [Diagnostics > Ports > Port Monitor](#) dialog, [Link speed/Duplex mode detection](#) tab.

### Active

Displays if the port is currently disabled due to the parameters being exceeded.

Possible values:

- ▶ `marked`  
The port is currently disabled.
- ▶ `unmarked`  
The port is enabled.

### Buttons

You find the description of the standard buttons in section [“Buttons” on page 14](#).

**[Status]**

This tab displays the monitored parameters for which the *Auto-Disable* function is activated.

**Table**

## Reason

Displays the parameters that the device monitors.

Mark the adjacent checkbox so that the *Auto-Disable* function disables and, when applicable, enables the port again if the monitored parameters are exceeded.

## Category

Displays which function the adjacent parameter belongs to.

Possible values:

- ▶ `port-monitor`  
The parameter belongs to the functions in the *Diagnostics > Port > Port Monitor* menu.
- ▶ `network-security`  
The parameter belongs to the functions in the *Network Security* menu.
- ▶ `l2-redundancy`  
The parameter belongs to the functions in the *Switching > L2-Redundancy* menu.

## Auto-disable

Displays if the *Auto-Disable* function is activated/deactivated for the adjacent parameter.

Possible values:

- ▶ `marked`  
The *Auto-Disable* function for the adjacent parameters is active.  
The *Auto-Disable* function disables and, when applicable, enables the relevant port again if the monitored parameters are exceeded.
- ▶ `unmarked` (default setting)  
The *Auto-Disable* function for the adjacent parameters is inactive.

**Buttons**

You find the description of the standard buttons in section “Buttons” on page 14.

## Reset

Enables the port highlighted in the table again and resets its counter to 0. This affects the counters in the following dialogs:

- ▶ *Diagnostics > Ports > Port Monitor* dialog
  - *Link flap* tab
  - *CRC/Fragments* tab
  - *Overload detection* tab
- ▶ *Diagnostics > Ports > Auto-Disable* dialog

## 6.4.5 Port Mirroring

[Diagnostics > Ports > Port Mirroring]

The *Port Mirroring* function lets you copy received and sent data packets from selected ports to a destination port. You can watch and process the data stream using an analyzer or an RMON probe, connected to the destination port. The data packets remain unmodified on the source port.

**Note:** To enable the access to the device management using the destination port, mark the checkbox *Allow management* in the *Destination port* frame before you enable the *Port Mirroring* function.

### Operation

Operation

Enables/disables the *Port Mirroring* function.

Possible values:

- ▶ *On*  
The *Port Mirroring* function is enabled.  
The device copies the data packets from the selected source ports to the destination port.
- ▶ *Off* (default setting)  
The *Port Mirroring* function is disabled.

### Destination port

Primary port

Specifies the destination port.

Suitable ports are those ports that are not used for the following purposes:

- Source port
- L2 redundancy protocols

Possible values:

- ▶ *no Port* (default setting)  
No destination port selected.
- ▶ *<Port number>*  
Number of the destination port. The device copies the data packets from the source ports to this port.

On the destination port, the device adds a VLAN tag to the data packets that the source port transmits. The destination port transmits unmodified the data packets that the source port receives.

**Note:** The destination port needs sufficient bandwidth to absorb the data stream. If the copied data stream exceeds the bandwidth of the destination port, then the device discards surplus data packets on the destination port.

## Allow management

Activates/deactivates the access to the device management using the destination port.

Possible values:

▶ `marked`

The access to the device management using the destination port is active.

The device lets users have access to the device management using the destination port without interrupting the active *Port Mirroring* session.

- The device duplicates multicasts, broadcasts and unknown unicasts on the destination port.
- The VLAN settings on the destination port remain unchanged. The prerequisite for access to the device management using the destination port is that the destination port is not a member of the VLAN of the device management.

▶ `unmarked` (default setting)

The access to the device management using the destination port is inactive.

The device prohibits the access to the device management using the destination port.

**Table**

## Source port

Specifies the port number.

Possible values:

▶ `<Port number>`

## Enabled

Activates/deactivates the copying of the data packets from this source port to the destination port.

Possible values:

▶ `marked`

The copying of the data packets is active.

The port is specified as a source port.

▶ `unmarked` (default setting)

The copying of the data packets is inactive.

## ▶ (Grayed-out display)

It is not possible to copy the data packets for this port.

Possible causes:

- The port is already specified as a destination port.
- The port is a logical port, not a physical port.

**Note:** The device lets you activate every physical port as source port except for the destination port.

## Type

Specifies which data packets the device copies to the destination port.

On the destination port, the device adds a VLAN tag to the data packets that the source port transmits. The destination port transmits unmodified the data packets that the source port receives.

Possible values:

▶ `none` (default setting)

No data packets.

- ▶ [tx](#)  
Data packets that the source port transmits.
- ▶ [rx](#)  
Data packets that the source port receives.
- ▶ [txrx](#)  
Data packets that the source port transmits and receives.

**Note:** With the [txrx](#) setting the device copies transmitted and received data packets. The destination ports needs at least a bandwidth that corresponds to the sum of the send and receive channel of the source ports. For example, for similar ports the destination port is at 100 % capacity when the send and receive channel of a source port are at 50 % capacity respectively.

## Buttons

You find the description of the standard buttons in section [“Buttons” on page 14](#).

### Reset config

Resets the settings in the dialog to the default settings and transfers the changes to the volatile memory of the device ([RAM](#)).

## 6.5 LLDP

[Diagnostics > LLDP]

The device lets you gather information about neighboring devices. For this, the device uses the Link Layer Discovery Protocol (LLDP). This information enables a network management station to map the structure of your network.

This menu lets you configure the topology discovery and to display the information received in table form.

The menu contains the following dialogs:

- ▶ [LLDP Configuration](#)
- ▶ [LLDP Topology Discovery](#)

## 6.5.1 LLDP Configuration

[Diagnostics > LLDP > Configuration]

This dialog lets you configure the topology discovery for every port.

### Operation

Operation

Enables/disables the *LLDP* function.

Possible values:

- ▶ *On* (default setting)  
The *LLDP* function is enabled.  
The topology discovery using LLDP is active in the device.
- ▶ *Off*  
The *LLDP* function is disabled.

### Configuration

Transmit interval [s]

Specifies the interval in seconds at which the device transmits LLDP data packets.

Possible values:

- ▶ 5..32768 (default setting: 30)

Transmit interval multiplier

Specifies the factor for determining the time-to-live value for the LLDP data packets.

Possible values:

- ▶ 2..10 (default setting: 4)

The time-to-live value coded in the LLDP header results from multiplying this value with the value in the *Transmit interval [s]* field.

Reinit delay [s]

Specifies the delay in seconds for the reinitialization of a port.

Possible values:

- ▶ 1..10 (default setting: 2)

If in the *Operation* column the value *Off* is specified, then the device tries to reinitialize the port after the time specified here has elapsed.

#### Transmit delay [s]

Specifies the delay in seconds for transmitting successive LLDP data packets after configuration changes in the device occur.

Possible values:

- ▶ 1..8192 (default setting: 2)

The recommended value is between a minimum of 1 and a maximum of a quarter of the value in the *Transmit interval [s]* field.

#### Notification interval [s]

Specifies the interval in seconds for transmitting LLDP notifications.

Possible values:

- ▶ 5..3600 (default setting: 5)

After transmitting a notification trap, the device waits for a minimum of the time specified here before transmitting the next notification trap.

### Table

#### Port

Displays the port number.

#### Operation

Specifies if the port transmits and receives LLDP data packets.

Possible values:

- ▶ *transmit*  
The port transmits LLDP data packets but does not save any information about neighboring devices.
- ▶ *receive*  
The port receives LLDP data packets but does not transmit any information to neighboring devices.
- ▶ *receive and transmit* (default setting)  
The port transmits LLDP data packets and saves information about neighboring devices.
- ▶ *disabled*  
The port does not transmit LLDP data packets and does not save information about neighboring devices.

#### Notification

Activates/deactivates the LLDP notifications on the port.

Possible values:

- ▶ *marked*  
LLDP notifications are active on the port.
- ▶ *unmarked* (default setting)  
LLDP notifications are inactive on the port.



### Transmit port description

Activates/deactivates the transmitting of a TLV (Type Length Value) with the port description.

Possible values:

- ▶ `marked` (default setting)  
The transmitting of the TLV is active.  
The device transmits the TLV with the port description.
- ▶ `unmarked`  
The transmitting of the TLV is inactive.  
The device does not transmit a TLV with the port description.

### Transmit system name

Activates/deactivates the transmitting of a TLV (Type Length Value) with the device name.

Possible values:

- ▶ `marked` (default setting)  
The transmitting of the TLV is active.  
The device transmits the TLV with the device name.
- ▶ `unmarked`  
The transmitting of the TLV is inactive.  
The device does not transmit a TLV with the device name.

### Transmit system description

Activates/deactivates the transmitting of the TLV (Type Length Value) with the system description.

Possible values:

- ▶ `marked` (default setting)  
The transmitting of the TLV is active.  
The device transmits the TLV with the system description.
- ▶ `unmarked`  
The transmitting of the TLV is inactive.  
The device does not transmit a TLV with the system description.

### Transmit system capabilities

Activates/deactivates the transmitting of the TLV (Type Length Value) with the system capabilities.

Possible values:

- ▶ `marked` (default setting)  
The transmitting of the TLV is active.  
The device transmits the TLV with the system capabilities.
- ▶ `unmarked`  
The transmitting of the TLV is inactive.  
The device does not transmit a TLV with the system capabilities.

#### Neighbors (max.)

Limits the number of neighboring devices to be recorded for this port.

Possible values:

- ▶ `1..50` (default setting: 10)

#### FDB mode

Specifies which function the device uses to record neighboring devices on this port.

Possible values:

- ▶ `lldpOnly`  
The device uses only LLDP data packets to record neighboring devices on this port.
- ▶ `macOnly`  
The device uses learned MAC addresses to record neighboring devices on this port. The device uses the MAC address only if there is no other entry in the address table (FDB, Forwarding Database) for this port.
- ▶ `both`  
The device uses LLDP data packets and learned MAC addresses to record neighboring devices on this port.
- ▶ `autoDetect` (default setting)  
If the device receives LLDP data packets at this port, then the device operates the same as with the `lldpOnly` setting. Otherwise, the device operates the same as with the `macOnly` setting.

### Buttons

You find the description of the standard buttons in section [“Buttons” on page 14](#).

## 6.5.2 LLDP Topology Discovery

[Diagnostics > LLDP > Topology Discovery]

Devices in networks send notifications in the form of packets which are also known as "LLDPDU" (LLDP data units). The data that is sent and received via LLDPDU are useful for many reasons. Thus the device detects which devices in the network are neighbors and via which ports they are connected.

The dialog lets you display the network and to detect the connected devices along with their specific features.

The dialog contains the following tabs:

- ▶ [LLDP]
- ▶ [LLDP-MED]

### [LLDP]

This tab displays the collected LLDP information for the neighboring devices. This information enables a network management station to map the structure of your network.

When devices both with and without an active topology discovery function are connected to a port, the topology table hides the devices without active topology discovery.

When only devices without active topology discovery are connected to a port, the table contains one line for this port to represent every device. This line contains the number of connected devices.

The Forwarding Database (FDB) address table contains MAC addresses of devices that the topology table hides for the sake of clarity.

When you use one port to connect several devices, for example via a hub, the table contains one line for each connected device.

### Table

Port

Displays the port number.

Neighbor identifier

Displays the chassis ID of the neighboring device. This can be the basis MAC address of the neighboring device, for example.

## FDB

Displays if the connected device has active LLDP support.

Possible values:

- ▶ `marked`  
The connected device does not have active LLDP support.  
The device uses information from its address table (FDB, Forwarding Database)
- ▶ `unmarked` (default setting)  
The connected device has active LLDP support.

## Neighbor IP address

Displays the IP address with which the access to the neighboring device management is possible.

## Neighbor port description

Displays a description for the port of the neighboring device.

## Neighbor system name

Displays the device name of the neighboring device.

## Neighbor system description

Displays a description for the neighboring device.

## Port ID

Displays the ID of the port through which the neighboring device is connected to the device.

## Autonegotiation supported

Displays if the port of the neighboring device supports autonegotiation.

## Autonegotiation

Displays if autonegotiation is enabled on the port of the neighboring device.

## PoE supported

Displays if the port of the neighboring device supports Power over Ethernet (PoE).

## PoE enabled

Displays if Power over Ethernet (PoE) is enabled on the port of the neighboring device.

## Buttons

You find the description of the standard buttons in section [“Buttons” on page 14](#).

**[LLDP-MED]**

LLDP for Media Endpoint Devices (LLDP-MED) is an extension to LLDP that operates between endpoint devices and network devices. It specifically provides support for VoIP applications. In this support rule, it provides an additional set of common advertisement, Type Length Value (TLV), messages. The device uses the TLVs for capabilities discovery such as network policy, Power over Ethernet, inventory management and location information.

**Table**

## Port

Displays the port number.

## Device class

Displays the device class of the remotely connected device.

- ▶ A value of `notDefined` indicates that the device has capabilities not covered by any of the *LLDP-MED* classes.
- ▶ A value of `endpointClass1..3` indicates that the device has "endpoint class 1..3" capabilities.
- ▶ A value of `networkConnectivity` indicates that the device has network connectivity device capabilities.

## VLAN ID

Displays the extension of the VLAN Identifier for the remote system connected to this port, as defined in IEEE 802.3.

- ▶ The device uses a value from 1 through 4042 to specify a valid Port VLAN ID.
- ▶ The device displays the value 0 for priority tagged packets. This means that only the 802.1D priority is significant and the device uses the default VLAN ID of the ingress port.

## Priority

Displays the value of the 802.1D priority which is associated with the remote system connected to the port.

## DSCP

Displays the value of the Differentiated Service Code Point (DSCP) which is associated with the remote system connected to the port.

## Unknown bit status

Displays the unknown bit status of incoming traffic.

- ▶ A value of `true` indicates that the network policy for the specified application type is currently unknown. In this case, the VLAN ID ignores the Layer 2 priority and value of the *DSCP* field.
- ▶ A value of `false` indicates a specified network policy.

#### Tagged bit status

Displays the tagged bit status.

- ▶ A value of `true` indicates that the application uses a tagged VLAN.
- ▶ A value of `false` indicates that for the specific application the device uses untagged VLAN operation. In this case, the device ignores both the VLAN ID and the Layer 2 priority fields. The DSCP value, however, is relevant.

#### Hardware revision

Displays the vendor-specific hardware revision string as advertised by the remote endpoint.

#### Firmware revision

Displays the vendor-specific firmware revision string as advertised by the remote endpoint.

#### Software revision

Displays the vendor-specific software revision string as advertised by the remote endpoint.

#### Serial number

Displays the vendor-specific serial number as advertised by the remote endpoint.

#### Manufacturer name

Displays the vendor-specific manufacturer name as advertised by the remote endpoint.

#### Model name

Displays the vendor-specific model name as advertised by the remote endpoint.

#### Asset ID

Displays the vendor-specific asset tracking identifier as advertised by the remote endpoint.

### Buttons

You find the description of the standard buttons in section [“Buttons” on page 14](#).

## 6.6 Report

[Diagnostics > Report]

The menu contains the following dialogs:

- ▶ [Report Global](#)
- ▶ [Persistent Logging](#)
- ▶ [System Log](#)
- ▶ [Audit Trail](#)

## 6.6.1 Report Global

[Diagnostics > Report > Global]

The device lets you log specific events using the following outputs:

- ▶ on the console
- ▶ on one or more syslog servers
- ▶ on a connection to the Command Line Interface set up using SSH
- ▶ on a connection to the Command Line Interface set up using Telnet

In this dialog you specify the required settings. By assigning the severity you specify which events the device registers.

The dialog lets you save a ZIP archive with system information on your PC.

### Console logging

#### Operation

Enables/disables the *Console logging* function.

Possible values:

- ▶ *On*  
The *Console logging* function is enabled.  
The device logs the events on the console.
- ▶ *Off* (default setting)  
The *Console logging* function is disabled.

#### Severity

Specifies the minimum severity for the events. The device logs events with this severity and with more urgent severities.

The device outputs the messages on the serial interface.

Possible values:

- ▶ *emergency*
- ▶ *alert*
- ▶ *critical*
- ▶ *error*
- ▶ *warning* (default setting)
- ▶ *notice*
- ▶ *informational*
- ▶ *debug*

## Buffered logging

The device buffers logged events in 2 separate storage areas so that the log entries for urgent events are kept.

This dialog lets you specify the minimum severity for events that the device buffers in the storage area with a higher priority.

### Severity

Specifies the minimum severity for the events. The device buffers log entries for events with this severity and with more urgent severities in the storage area with a higher priority.

Possible values:

- ▶ `emergency`
- ▶ `alert`
- ▶ `critical`
- ▶ `error`
- ▶ `warning` (default setting)
- ▶ `notice`
- ▶ `informational`
- ▶ `debug`

## SNMP logging

When you enable the logging of SNMP requests, the device sends these as events with the preset severity `notice` to the list of syslog servers. The preset minimum severity for a syslog server entry is `critical`.

To send SNMP requests to a syslog server, you have a number of options to change the default settings. Select the ones that meet your requirements best.

- Set the severity for which the device creates SNMP requests as events to `warning` or `error`. Change the minimum severity for a syslog entry for one or more syslog servers to the same value.  
You also have the option of creating a separate syslog server entry for this.
- Set only the severity for SNMP requests to `critical` or higher. The device then sends SNMP requests as events with the severity `critical` or higher to the syslog servers.
- Set only the minimum severity for one or more syslog server entries to `notice` or lower. Then it is possible that the device sends many events to the syslog servers.

### Log SNMP get request

Enables/disables the logging of SNMP Get requests.

Possible values:

- ▶ `On`  
The logging is enabled.  
The device registers SNMP Get requests as events in the syslog.  
In the *Severity get request* drop-down list, you select the severity for this event.
- ▶ `Off` (default setting)  
The logging is disabled.



### Log SNMP set request

Enables/disables the logging of SNMP Set requests.

Possible values:

- ▶ *On*  
The logging is enabled.  
The device registers SNMP Set requests as events in the syslog.  
In the *Severity set request* drop-down list, you select the severity for this event.
- ▶ *Off* (default setting)  
The logging is disabled.

### Severity get request

Specifies the severity of the event that the device registers for SNMP Get requests.

Possible values:

- ▶ emergency
- ▶ alert
- ▶ critical
- ▶ error
- ▶ warning
- ▶ notice (default setting)
- ▶ informational
- ▶ debug

### Severity set request

Specifies the severity of the event that the device registers for SNMP Set requests.

Possible values:

- ▶ emergency
- ▶ alert
- ▶ critical
- ▶ error
- ▶ warning
- ▶ notice (default setting)
- ▶ informational
- ▶ debug

## CLI logging

### Operation

Enables/disables the *CLI logging* function.

Possible values:

- ▶ *On*  
The *CLI logging* function is enabled.  
The device logs every command received using the Command Line Interface.
- ▶ *Off* (default setting)  
The *CLI logging* function is disabled.

## Buttons

You find the description of the standard buttons in section “Buttons” on page 14.

### Download support information

Generates a ZIP archive which the web browser lets you download from the device.

The ZIP archive contains system information about the device. You will find an explanation of the files contained in the ZIP archive in the following section.

## Support Information: Files contained in ZIP archive

File name	Format	Comments
audittrail.html	HTML	Contains the chronological recording of the system events and saved user changes in the Audit Trail.
defaultconfig.xml	XML	Contains the configuration profile with the default settings.
script	TEXT	Contains the output of the command <code>show running-config script</code> .
runningconfig.xml	XML	Contains the configuration profile with the current operating settings.
supportinfo.html	TEXT	Contains device internal service information.
systeminfo.html	HTML	Contains information about the current settings and operating parameters.
systemlog.html	HTML	Contains the logged events in the Log file. See the <a href="#">Diagnostics &gt; Report &gt; System Log</a> dialog.

## Meaning of the event severities

Severity	Meaning
<i>emergency</i>	Device not ready for operation
<i>alert</i>	Immediate user intervention required
<i>critical</i>	Critical status

<b>Severity</b>	<b>Meaning</b>
<code>error</code>	Error status
<code>warning</code>	Warning
<code>notice</code>	Significant, normal status
<code>informational</code>	Informal message
<code>debug</code>	Debug message

## 6.6.2 Persistent Logging

[Diagnostics > Report > Persistent Logging]

The device lets you save log entries permanently in a file in the external memory. Therefore, even after the device is restarted you have access to the log entries.

In this dialog you limit the size of the log file and specify the minimum severity for the events to be saved. When the log file reaches the specified size, the device archives this file and saves the following log entries in a newly created file.

In the table the device displays you the log files held in the external memory. As soon as the specified maximum number of files has been attained, the device deletes the oldest file and renames the remaining files. This helps ensure that there is enough memory space in the external memory.

**Note:** Verify that an external memory is connected. To verify if an external memory is connected, see the *Status* column in the *Basic Settings > External Memory* dialog. We recommend to monitor the external memory connection using the *Device Status* function, see the *External memory removal* parameter in the *Diagnostics > Status Configuration > Device Status* dialog.

### Operation

Operation

Enables/disables the *Persistent Logging* function.

Only activate this function if the external memory is available in the device.

Possible values:

- ▶ *On* (default setting)  
The *Persistent Logging* function is enabled.  
The device saves the log entries in a file in the external memory.
- ▶ *Off*  
The *Persistent Logging* function is disabled.

### Configuration

Max. file size [kbyte]

Specifies the maximum size of the log file in KBytes. When the log file reaches the specified size, the device archives this file and saves the following log entries in a newly created file.

Possible values:

- ▶ *0..4096* (default setting: *1024*)

The value *0* deactivates saving of log entries in the log file.

### Files (max.)

Specifies the number of log files that the device keeps in the external memory.

As soon as the specified maximum number of files has been attained, the device deletes the oldest file and renames the remaining files.

Possible values:

- ▶ 0..25 (default setting: 4)

The value 0 deactivates saving of log entries in the log file.

### Severity

Specifies the minimum severity of the events. The device saves the log entry for events with this severity and with more urgent severities in the log file in the external memory.

Possible values:

- ▶ emergency
- ▶ alert
- ▶ critical
- ▶ error
- ▶ warning (default setting)
- ▶ notice
- ▶ informational
- ▶ debug

### Log file target

Specifies the external memory device for logging.

Possible values:

- ▶ sd  
External SD memory (ACA31)
- ▶ usb  
External USB memory (ACA21/ACA22)

## Table

### Index

Displays the index number to which the table entry relates.

Possible values:

- ▶ 1..25

The device automatically assigns this number.

File name

Displays the file name of the log file in the external memory.

Possible values:

- ▶ [messages](#)
- ▶ [messages.X](#)

File size [byte]

Displays the size of the log file in the external memory in bytes.

### Buttons

You find the description of the standard buttons in section [“Buttons” on page 14](#).

Delete persistent log file

Removes the log files from the external memory.

## 6.6.3 System Log

[Diagnostics > Report > System Log]

The device logs device-internal events in a log file (System Log).

This dialog displays the log file (System Log). The dialog lets you save the log file in HTML format on your PC.

In order to search the log file for search terms, use the search function of your web browser.

The log file is kept until a restart is performed in the device. After the restart the device creates the file again.

### Buttons

You find the description of the standard buttons in section [“Buttons” on page 14](#).

Save log file

Opens the HTML page in a new web browser window or tab. You can save the HTML page on your PC using the appropriate web browser command.

Delete log file

Removes the logged events from the log file.

## 6.6.4 Audit Trail

[Diagnostics > Report > Audit Trail]

This dialog displays the log file (Audit Trail). The dialog lets you save the log file as an HTML file on your PC.

In order to search the log file for search terms, use the search function of your web browser.

The device logs system events and writing user actions in the device. This lets you keep track of WHO changes WHAT in the device and WHEN. The prerequisite is that the user role [auditor](#) or [administrator](#) is assigned to your user account.

The device logs the following user actions, among others:

- ▶ A user logging in with the Command Line Interface (local or remote)
- ▶ A user logging off manually
- ▶ Automatic logging off of a user in the Command Line Interface after a specified period of inactivity
- ▶ Device restart
- ▶ Locking of a user account due to too many unsuccessful login attempts
- ▶ Locking of the access to the device management due to unsuccessful login attempts
- ▶ Commands executed in the Command Line Interface, apart from `show` commands
- ▶ Changes to configuration variables
- ▶ Changes to the system time
- ▶ File transfer operations, including firmware updates
- ▶ Configuration changes via HiDiscovery
- ▶ Firmware updates and automatic configuration of the device via the external memory
- ▶ Opening and closing of SNMP via an HTTPS tunnel

The device does not log passwords. The logged entries are write-protected and remain saved in the device after a restart.

**Note:** During the restart, access to the system monitor is possible using the default settings of the device. If an attacker gains physical access to the device, then he is able to reset the device settings to its default values using the system monitor. After this, the device and log file are accessible using the standard password. Take appropriate measures to restrict physical access to the device. Otherwise, deactivate access to the system monitor. See the [Diagnostics > System > Selftest](#) dialog, [SysMon1 is available](#) checkbox.

### Buttons

You find the description of the standard buttons in section [“Buttons” on page 14](#).

Save audit trail file

Opens the HTML page in a new web browser window or tab. You can save the HTML page on your PC using the appropriate web browser command.





## 7 Advanced

The menu contains the following dialogs:

- ▶ [DHCP L2 Relay](#)
- ▶ [DHCP Server](#)
- ▶ [Industrial Protocols](#)
- ▶ [Command Line Interface](#)

### 7.1 DHCP L2 Relay

[Advanced > DHCP L2 Relay]

A network administrator uses the DHCP L2 *Relay Agent* to add DHCP client information. L3 *Relay Agents* and DHCP servers need the DHCP client information to assign an IP address and a configuration to the clients.

When active, the relay adds *Option 82* information configured in this dialog to the packets before it relays DHCP requests from the clients to the server. The *Option 82* fields provide unique information about the client and relay. This unique identifier consists of a *Circuit ID* for the client and a *Remote ID* for the relay.

In addition to the type, length, and multicast fields, the *Circuit ID* includes the VLAN ID, unit number, slot number, and port number for the connected client.

The *Remote ID* consists of a type and length field and either a MAC address, IP address, client identifier, or a user-defined device description. A client identifier is the user-defined system name for the device.

The menu contains the following dialogs:

- ▶ [DHCP L2 Relay Configuration](#)
- ▶ [DHCP L2 Relay Statistics](#)

## 7.1.1 DHCP L2 Relay Configuration

[Advanced > DHCP L2 Relay > Configuration]

This dialog lets you activate the relay function on an interface and VLAN. When you activate this function on a port, the device either relays the *Option 82* information or drops the information on untrusted ports. Furthermore, the device lets you specify the remote identifier.

The dialog contains the following tabs:

- ▶ [Interface]
- ▶ [VLAN ID]

### Operation

Operation

Enables/disables the DHCP L2 Relay function of the device globally.

Possible values:

- ▶ *On*  
Enables the *DHCP L2 Relay* function in the device.
- ▶ *OFF* (default setting)  
Disables the *DHCP L2 Relay* function in the device.

### [Interface]

#### Table

Port

Displays the port number.

Active

Activates/deactivates the *DHCP L2 Relay* function on the port.

The prerequisite is that you enable the function globally.

Possible values:

- ▶ *marked*  
The *DHCP L2 Relay* function is active.
- ▶ *unmarked* (default setting)  
The *DHCP L2 Relay* function is inactive.

#### Trusted port

Activates/deactivates the secure *DHCP L2 Relay* mode for the corresponding port.

Possible values:

- ▶ *marked*  
The device accepts DHCPv4 packets with *Option 82* information.
- ▶ *unmarked* (default setting)  
The device discards DHCPv4 packets received on non-secure ports that contain *Option 82* information.

#### Buttons

You find the description of the standard buttons in section “Buttons” on page 14.

#### [VLAN ID]

#### Table

##### VLAN ID

VLAN to which the table entry relates.

##### Active

Activates/deactivates the *DHCP L2 Relay* function on the VLAN.

The prerequisite is that you enable the function globally.

Possible values:

- ▶ *marked*  
The *DHCP L2 Relay* function is active.
- ▶ *unmarked* (default setting)  
The *DHCP L2 Relay* function is inactive.

##### Circuit ID

Activates or deactivates the addition of the *Circuit ID* to the *Option 82* information.

Possible values:

- ▶ *marked* (default setting)  
Enables *Circuit ID* and *Remote ID* to be sent together.
- ▶ *unmarked*  
The device sends only the *Remote ID*.

#### Remote ID type

Specifies the components of the *Remote ID* for this VLAN.

Possible values:

- ▶ `ip`  
Specifies the IP address of the device as *Remote ID*.
- ▶ `mac` (default setting)  
Specifies the MAC address of the device as *Remote ID*.
- ▶ `client-id`  
Specifies the system name of the device as *Remote ID*.
- ▶ `other`  
When you use this value, enter in the *Remote ID* column user-defined information.

#### Remote ID

Displays the *Remote ID* for the VLAN.

When you specify the value `other` in the *Remote ID type* column, specify the identifier.

### **Buttons**

You find the description of the standard buttons in section “Buttons” on page 14.

## 7.1.2 DHCP L2 Relay Statistics

[Advanced > DHCP L2 Relay > Statistics]

The device monitors the traffic on the ports and displays the results in tabular form.

This table is divided into various categories to aid you in traffic analysis.

### Table

Port

Displays the port number.

Untrusted server messages with Option 82

Displays the number of DHCP server messages received with *Option 82* information on the untrusted interface.

Untrusted client messages with Option 82

Displays the number of DHCP client messages received with *Option 82* information on the untrusted interface.

Trusted server messages without Option 82

Displays the number of DHCP server messages received without *Option 82* information on the trusted interface.

Trusted client messages without Option 82

Displays the number of DHCP client messages received without *Option 82* information on the trusted interface.

### Buttons

You find the description of the standard buttons in section [“Buttons” on page 14](#).

Reset

Resets the entire table.

## 7.2 DHCP Server

[Advanced > DHCP Server]

With the DHCP server, you manage a database of available IP addresses and configuration information. When the device receives a request from a client, the DHCP server validates the DHCP client network, and then leases an IP address. When activated, the DHCP server also allocates configuration information appropriate for that client. The configuration information specifies, for example, which IP address, DNS server and the default route a client uses.

The DHCP server assigns an IP address to a client for a user-defined interval. The DHCP client is responsible for renewing the IP address before the interval expires. When the DHCP client is unable to renew the address, the address returns to the pool for reassignment.

The menu contains the following dialogs:

- ▶ [DHCP Server Global](#)
- ▶ [DHCP Server Pool](#)
- ▶ [DHCP Server Lease Table](#)

## 7.2.1 DHCP Server Global

[Advanced > DHCP Server > Global]

Activate the function either globally or per port according to your requirements.

### Operation

Operation

Enables/disables the DHCP server function of the device globally.

Possible values:

- ▶ *On*
- ▶ *Off* (default setting)

### Table

Port

Displays the port number.

DHCP server active

Activates/deactivates the DHCP server function on this port.

The prerequisite is that you enable the function globally.

Possible values:

- ▶ *marked* (default setting)  
The DHCP server function is active.
- ▶ *unmarked*  
The DHCP server function is inactive.

### Buttons

You find the description of the standard buttons in section [“Buttons” on page 14](#).



## 7.2.2 DHCP Server Pool

[Advanced > DHCP Server > Pool]

Assign an IP address to an end device or switch connected to a port or included in a VLAN.

The DHCP server provides IP address pools from which it allocates IP addresses to clients. A pool consists of a list of entries. Specify an entry as static to a specific IP address, or as dynamic to an IP address range. The device holds a maximum of 128 pools. The pools together hold a maximum of 1000 entries.

With static allocation, the DHCP server assigns an IP address to a specific client. The DHCP server identifies the client using a unique hardware ID. A static address entry contains one IP address. You apply this IP address to every port or to a specific port of the device. For static allocation, enter an IP address for allocation in the *IP address* field, and leave the *Last IP address* column empty. Enter a hardware ID with which the DHCP server uniquely identifies the client. This ID is either a MAC address, a Client ID, a Remote ID, or a Circuit ID. When a client contacts the device with a known hardware ID, the DHCP server allocates the static IP address.

In dynamic allocation, when a DHCP client makes contact on a port, the DHCP server assigns an available IP address from a pool for this port. For dynamic allocation, create a pool for the ports by assigning an IP address range. Specify the first and last IP addresses for the IP address range. Leave the *MAC address*, *Client ID*, *Remote ID* and *Circuit ID* fields empty. You have the option of creating multiple pool entries. This lets you create an IP address range that contains gaps.

This dialog displays the different information that is required for the assignment of an IP address for a port or a VLAN. Use the  button to add an entry. The device adds a writable and readable entry.

### Table

Index

Displays the index number to which the table entry relates.

Active

Activates/deactivates the DHCP server function on this port.

Possible values:

- ▶ *marked*  
The DHCP server function is active.
- ▶ *unmarked* (default setting)  
The DHCP server function is inactive.

#### IP address

Specifies the IP address for static IP address assignment. When using dynamic IP address assignment, this value specifies the start of the IP address range.

Possible values:

- ▶ Valid IPv4 address

#### Last IP address

When using dynamic IP address assignment, this value specifies the end of the IP address range.

Possible values:

- ▶ Valid IPv4 address

#### Port

Displays the port number.

#### VLAN ID

Displays the VLAN to which the table entry relates.

A value of 1 corresponds to the default device management VLAN.

Possible values:

- ▶ 1..4042

#### MAC address

Specifies the MAC address of the device leasing the IP address.

Possible values:

- ▶ Valid Unicast MAC address  
Specify the value with a colon separator, for example 00:11:22:33:44:55.
- ▶ -  
For the IP address assignment, the server ignores this variable.

#### DHCP relay

Specifies the IP address of the DHCP relay through which the clients transmit their requests to the DHCP server. When the DHCP server receives the client's request through another DHCP relay, it ignores this request.

Possible values:

- ▶ Valid IPv4 address  
IP address of the DHCP relay.
- ▶ -  
Between the client and the DHCP server there is no DHCP relay.

#### Client ID

Specifies the identification of the client device leasing the IP address.

Possible values:

- ▶ 1..80 bytes (format `XX XX .. XX`)
- ▶ -  
For the IP address assignment, the server ignores this variable.

#### Remote ID

Specifies the identification of the remote device leasing the IP address.

Possible values:

- ▶ 1..80 bytes (format `XX XX .. XX`)
- ▶ -  
For the IP address assignment, the server ignores this variable.

#### Circuit ID

Specifies the Circuit ID of the device leasing the IP address.

Possible values:

- ▶ 1..80 bytes (format `XX XX .. XX`)
- ▶ -  
For the IP address assignment, the server ignores this variable.

#### Hirschmann device

Activates/deactivates Hirschmann multicasts.

If the device in this IP address range serves only Hirschmann devices, then activate this function.

Possible values:

- ▶ `marked`  
In this IP address range, the device serves only Hirschmann devices. Hirschmann multicasts are activated.
- ▶ `unmarked` (default setting)  
In this IP address range, the device serves the devices of different manufacturers. Hirschmann multicasts are deactivated.

#### Configuration URL

Specifies the protocol to be used as well as the name and path of the configuration file.

Possible values:

- ▶ Alphanumeric ASCII character string with 0..70 characters  
Example: `tftp://192.9.200.1/cfg/config.xml`

When you leave this field blank, the device leaves this option field blank in the DHCP message.

#### Lease time [s]

Specifies the lease time in seconds.

Possible values:

- ▶ 1..4294967294 (default setting: 86400)
- ▶ 4294967295

Use this value for assignments unlimited in time and for assignments via BOOTP.

#### Default gateway

Specifies the IP address of the default gateway.

A value of 0.0.0.0 disables the attachment of the option field in the DHCP message.

Possible values:

- ▶ Valid IPv4 address

#### Netmask

Specifies the mask of the network to which the client belongs.

A value of 0.0.0.0 disables the attachment of the option field in the DHCP message.

Possible values:

- ▶ Valid IPv4 netmask

#### WINS server

Specifies the IP address of the Windows Internet Name Server which converts NetBIOS names.

A value of 0.0.0.0 disables the attachment of the option field in the DHCP message.

Possible values:

- ▶ Valid IPv4 address

#### DNS server

Specifies the IP address of the DNS server.

A value of 0.0.0.0 disables the attachment of the option field in the DHCP message.

Possible values:

- ▶ Valid IPv4 address

#### Hostname

Specifies the hostname.

When you leave this field blank, the device leaves this option field blank in the DHCP message.

Possible values:

- ▶ Alphanumeric ASCII character string with 0..64 characters

### **Buttons**

You find the description of the standard buttons in section [“Buttons” on page 14](#).

## 7.2.3 DHCP Server Lease Table

[Advanced > DHCP Server > Lease Table]

This dialog displays the status of IP address leasing on a per port basis.

### Table

Port

Displays the port number to which the address is currently being leased.

IP address

Displays the leased IP address to which the entry refers.

Status

Displays the lease phase.

According to the standard for DHCP operations, there are 4 phases to leasing an IP address: Discovery, Offer, Request, and Acknowledgement.

Possible values:

- ▶ `bootp`  
A DHCP client is attempting to discover a DHCP server for IP address allocation.
- ▶ `offering`  
The DHCP server is validating that the IP address is suitable for the client.
- ▶ `requesting`  
A DHCP client is acquiring the offered IP address.
- ▶ `bound`  
The DHCP server is leasing the IP address to a client.
- ▶ `renewing`  
The DHCP client is requesting an extension to the lease.
- ▶ `rebinding`  
The DHCP server is assigning the IP address to the client after a successful renewal.
- ▶ `declined`  
The DHCP server denied the request for the IP address.
- ▶ `released`  
The IP address is available for other clients.

Remaining lifetime

Displays the time remaining on the leased IP address.

Leased MAC address

Displays the MAC address of the device leasing the IP address.

Gateway

Displays the Gateway IP address of the device leasing the IP address.

Client ID

Displays the client identifier of the device leasing the IP address.

Remote ID

Displays the remote identifier of the device leasing the IP address.

Circuit ID

Displays the Circuit ID of the device leasing the IP address.

**Buttons**

You find the description of the standard buttons in section [“Buttons” on page 14](#).

## 7.3 Industrial Protocols

[Advanced > Industrial Protocols]

The menu contains the following dialogs:

- ▶ [IEC61850-MMS](#)
- ▶ [Modbus TCP](#)
- ▶ [EtherNet/IP](#)
- ▶ [PROFINET](#)

## 7.3.1 IEC61850-MMS

[Advanced > Industrial Protocols > IEC61850-MMS]

The IEC61850-MMS is a standardized industrial communication protocol from the International Electrotechnical Commission (IEC). For example, automatic switching equipment uses this protocol when communicating with power station equipment.

The packet orientated protocol defines a uniform communication language based on the transport protocol, TCP/IP. The protocol uses a Manufacturing Message Specification (MMS) server for client server communications. The protocol includes functions for SCADA, Intelligent Electronic Device (IED) and the network control systems.

**Note:** IEC61850/MMS does not provide any authentication mechanisms. If the write access for IEC61850/MMS is activated, then every client that can access the device using TCP/IP is capable of changing the settings of the device. This in turn can result in an incorrect configuration of the device and to failures in the network.

Activate the write access only if you have taken additional measures (for example Firewall, VPN, etc.) to reduce possible unauthorized access.

This dialog lets you specify the following MMS server settings:

- ▶ Activates/deactivates the MMS server.
- ▶ Activates/deactivates the write access to the MMS server.
- ▶ The MMS server TCP Port.
- ▶ The maximum number of MMS server sessions.

### Operation

#### Operation

Enables/disables the *IEC61850-MMS* server.

Possible values:

- ▶ *On*  
The *IEC61850-MMS* server is enabled.
- ▶ *Off* (default setting)  
The *IEC61850-MMS* server is disabled.  
The IEC61850 MIBs stay accessible.



## Configuration

### Write access

Activates/deactivates the write access to the MMS server.

Possible values:

- ▶ `marked`  
The write access to the MMS server is activated. This setting lets you change the device settings using the IEC 61850 MMS protocol.
- ▶ `unmarked` (default setting)  
The write access to the MMS server is deactivated. The MMS server is accessible as read-only.

### Technical key

Specifies the IED name.

The IED name is eligible independently of the system name.

Possible values:

- ▶ Alphanumeric ASCII character string with 0..32 characters  
The following characters are allowed:
  - `-`
  - `0..9`
  - `a..z`
  - `A..Z` (default setting: `KEY`)

To get the MMS server to use the IED name, click the  button and restart the MMS server. The connection to connected clients is then interrupted.

### TCP port

Specifies TCP port for MMS server access.

Possible values:

- ▶ `1..65535` (default setting: `102`)  
Exception: Port `2222` is reserved for internal functions.

**Note:** The server restarts automatically after you change the port. In the process, the device terminates open connections to the server.

#### Sessions (max.)

Specifies the maximum number of MMS server connections.

Possible values:

- ▶ 1..15 (default setting: 5)

### Information

#### Status

Displays the current *IEC61850-MMS* server status.

Possible values:

- ▶ *unavailable*
- ▶ *starting*
- ▶ *running*
- ▶ *stopping*
- ▶ *halted*
- ▶ *error*

#### Active sessions

Displays the number of active MMS server connections.

### Buttons

You find the description of the standard buttons in section [“Buttons” on page 14](#).

#### Download ICD file

Copies the ICD file to your PC.

## 7.3.2 Modbus TCP

[Advanced > Industrial Protocols > Modbus TCP]

*Modbus TCP* is a protocol used for Supervisory Control and Data Acquisition (SCADA) system integration. *Modbus TCP* is a vendor-neutral protocol used to monitor and control industrial automation equipment such as Programmable Logic Controllers (PLC), sensors and meters.

This dialog lets you specify the parameters of the protocol. To monitor and control the parameters of the device, you need Human-Machine Interface (HMI) software and the memory mapping table. Refer to the tables located in the “Configuration” user manual for the supported objects and memory mapping.

The dialog lets you enable the function, activate the write access, control which TCP port the Human-Machine Interface (HMI) polls for data. You can also specify the number of sessions allowed to be open at the same time.

**Note:** Activating the *Modbus TCP* write-access can cause an unavoidable security risk, because the protocol does not authenticate user access.

To help minimize the unavoidable security risks, specify the IP address range located in the *Device Security > Management Access* dialog. Enter only the IP addresses assigned to your devices before enabling the function. Furthermore, the default setting for monitoring function activation in the *Diagnostics > Status Configuration > Security Status* dialog, *Global* tab, is active.

### Operation

Operation

Enables/disables the *Modbus TCP* server in the device.

Possible values:

- ▶ *On*  
The *Modbus TCP* server is enabled.
- ▶ *OFF* (default setting)  
The *Modbus TCP* server is disabled.

### Configuration

Write access

Activates/deactivates the write access to the *Modbus TCP* parameters.

**Note:** Activating the *Modbus TCP* write-access can cause an unavoidable security risk, because the protocol does not authenticate user access.

Possible values:

- ▶ `marked` (default setting)  
The *Modbus TCP* server read/write access is active. This lets you change the device configuration using the *Modbus TCP* protocol.
- ▶ `unmarked`  
The *Modbus TCP* server read-only access is active.

TCP port

Specifies the TCP port number that the *Modbus TCP* server uses for communication.

Possible values:

- ▶ `<TCP Port number>` (default setting: 502)  
Specifying 0 is not allowed.

Sessions (max.)

Specifies the maximum number of concurrent sessions that the *Modbus TCP* server maintains.

Possible values:

- ▶ `1..5` (default setting: 5)

## Buttons

You find the description of the standard buttons in section [“Buttons” on page 14](#).

### 7.3.3 PROFINET

[Advanced > Industrial Protocols > PROFINET]

This dialog lets you configure the PROFINET protocol on this device used in conjunction with PROFINET Controllers and PROFINET devices. The device bases the *PROFINET* function on the Siemens V2.2 PROFINET stack for common Ethernet controllers. The PROFINET protocol implemented in the device conforms to Class B for real time responses according to IEC 61158.

Functions that directly affect the *PROFINET* function require the following default values to be changed. If you have obtained the device as a specially available *PROFINET* variant, then these values are already predefined:

#### PROFINET

*Advanced > Industrial Protocols > PROFINET* dialog

- *Operation* frame  
*Operation* = *On*
- *Configuration* frame  
*Name of station* field = <empty>

#### Network

*Basic Settings > Network* dialog

- *Management interface* frame  
*IP address assignment* radio button = *Local*
- *HiDiscovery protocol v1/v2* frame  
*Access* drop-down list = *readOnly*
- *IP parameter* frame  
*IP address* field = 0.0.0.0  
*Netmask* field = 0.0.0.0  
*Gateway address* field = 0.0.0.0

#### VLAN

*Switching > Global* dialog

- *Configuration* frame  
*VLAN unaware mode* checkbox = *marked*

#### LLDP

*Diagnostics > LLDP > Configuration* dialog

- *Configuration* frame  
*Transmit interval [s]* field = 5  
*Transmit delay [s]* field = 1

## Operation

### Operation

Enables/disables the *PROFINET* function in the device.

Possible values:

- ▶ *On*  
The *PROFINET* function is enabled.
- ▶ *Off* (default setting)  
The *PROFINET* function is disabled.

## Configuration

### Name of station

Specifies the name of the device.

Possible values:

- ▶ Alphanumeric ASCII character string with 0..240 characters  
The device prohibits you from using a number as the first character.

## Information

### Active application relations

Displays how many application relations are active.

## Table

### Port

Displays the port number.

### DCP mode

Specifies the data stream direction on the port to monitor for DCP packets.

The Programmable Logic Controller (PLC) detects PROFINET devices using the Discovery and Configuration Protocol (DCP).

The DCP identify request packets are multicast, the responses from the agents are unicast. Regardless of the settings, the device forwards the received DCP packets to other ports whose setting is either *egress* or *both*.

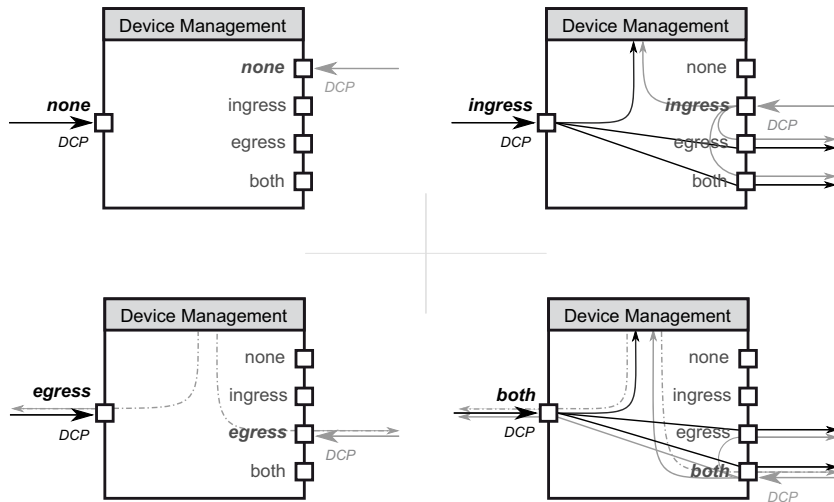

Possible values:

- ▶ *none*  
The agent does not respond to packets received on this port. The port does not forward packets received on other ports.
- ▶ *ingress*  
The agent responds to packets received on this port. The port does not forward packets received on other ports.
- ▶ *egress*  
The agent does not respond to packets received on this port. The port forwards packets received on other ports.
- ▶ *both* (default setting)  
The agent responds to packets received on this port. The port forwards packets received on other ports.

### Buttons

You find the description of the standard buttons in section “Buttons” on page 14.

Download GSDML file

Copies the GSDML file onto your PC.

## 7.3.4 EtherNet/IP

[Advanced > Industrial Protocols > EtherNet/IP]

This dialog lets you activate the *EtherNet/IP* protocol, to change the SET/GET capability and to download the EDS file from the device.

### Operation

Operation

Enables/disables the *EtherNet/IP* function in the device.

Possible values:

- ▶ *On*  
The *EtherNet/IP* function is enabled.
- ▶ *Off* (default setting)  
The *EtherNet/IP* function is disabled. The device continues to read the EtherNet/IP data.

### Configuration

Write access

Activates/deactivates the read/write capability of the *EtherNet/IP* protocol.

Possible values:

- ▶ *marked*  
The *EtherNet/IP* protocol accepts set/get requests.
- ▶ *unmarked* (default setting)  
The *EtherNet/IP* protocol accepts only get requests.

### Buttons

You find the description of the standard buttons in section “Buttons” on page 14.

Download EDS file

Copies the following information in a zip file onto your PC:

- ▶ Electronic Data Sheet (EDS) with device related information
- ▶ device icon



## 7.4 Command Line Interface

[Advanced > CLI]

This dialog lets you access the device using the Command Line Interface.

The prerequisites are:

- In the device, enable the SSH server in the [Device Security > Management Access > Server](#) dialog, tab [SSH](#).
- On your workstation, install a SSH-capable client application which registers a handler for URLs starting with `ssh://` in your operating system.

### Buttons

You find the description of the standard buttons in section [“Buttons” on page 14](#).

#### Open SSH connection

Opens the SSH-capable client application.

When you click the button, the web application passes the URL of the device starting with `ssh://` and the user name of the currently logged in user.

If the web browser finds a SSH-capable client application, then the SSH-capable client establishes a connection to the device using the SSH protocol.

## A Index

<b>0-9</b>	
802.1D/p mapping	237
802.1X	115, 152
<b>A</b>	
Access control	152
Access control lists	181
Access restriction	133
ACL	181
Address conflict detection	26, 333
Aging time	191, 337
Alarms	326
ARP	333
ARP table	337
Audit trail	383
Authentication history	164
Authentication list	115
Auto disable	148, 284, 352, 353, 360
<b>B</b>	
Boundary clock	81
Bridge	281
<b>C</b>	
Cable diagnosis	347
Certificate	19, 44, 130, 131, 316
CLI	138
Command line interface	138
Community names	141
Configuration check	331
Configuration profile	13, 34
Context menu	13
Counter reset	63
<b>D</b>	
Daylight saving time	68
Device software	31
Device software backup	31
Device status	17, 306
DHCP L2 relay	385
DHCP server	390
DLR (depends on hardware)	256
DoS	177
DSCP	239
<b>E</b>	
EAPOL	162
Egress rate limiter	194
Encryption	34
ENVM	32, 39, 45, 308, 314, 322, 380
EtherNet/IP	316, 407
Event severity	377
External memory	32, 39, 45, 380

---

<b>F</b>	
FAQ	415
Fast MRP	253
FDB	197
Filter MAC addresses	197
Fingerprint	125, 129
Flash memory	32, 330
Flow control	191
Forwarding database	197
<b>G</b>	
Guards	291
<b>H</b>	
Hardware clock	67
Hardware state	330
HiDiscovery	26, 315, 383
Host key	127
HSR (depends on hardware)	272
HTML	329, 382
HTTP	127
HTTP server	313
HTTPS	128
<b>I</b>	
IAS	115, 166
IEC61850-MMS	315, 399
IEEE 802.1X	115
IGMP snooping	199
Industrial HiVision	9, 121
Ingress filtering	248
Ingress rate limiter	194
Integrated authentication server	115, 166
IP access restriction	133
IP address conflict detection	333
IP DSCP mapping	239
IPv4 rule	183
<b>L</b>	
L2 relay	385
Link aggregation	294
Link backup	301
LLDP	365
Load/save	34
Log file	63, 382
Login banner	139, 142
Loops	280

<b>M</b>	
MAC Address Conflict Detection	26
MAC address table	197
MAC flood	147
MAC rule	186
MAC spoof	147
Management access	26, 133
Management VLAN	26
Manufacturing message specification	399
Media redundancy protocol	252
Menu	12
MMRP	225
MMS	399
Modbus TCP	316, 402
Modules	307, 321
MRP	252
MRP-IEEE	223
MVRP	230
<b>N</b>	
Network load	54
NVM	12, 13, 21, 32, 39
<b>P</b>	
Parallel redundancy protocol (depends on hardware)	265
Password	110, 312
Password length	110, 312
Persistent logging	379
PoE	56
Port clients	160
Port configuration	155, 235
Port mirroring	363
Port monitor	360
Port priority	235
Port security	147
Port statistics	162
Port VLAN	247
Port-based access control	152
Power over Ethernet	56
Power supply	20, 308, 322
Pre-Login banner	142
Priority queue	234
PROFINET	316, 404
PRP (depends on hardware)	265
<b>Q</b>	
Queue management	241
Queues	234

<b>R</b>	
RADIUS	115, 167
RAM	38
RAM test	338
Rate limiter	194
Reboot	63
Relay	385
Request interval	73
Ring structure	252
Root bridge	281
RSTP	280, 281
<b>S</b>	
Secure shell	124
Security status	18, 311
Self-test	338
Serial interface	314
Settings	34
Severity	377
SFP module	345
Signal contact	18, 318
SNMP server	121, 313
SNMP traps	52, 57, 59, 149, 281, 297, 306, 311, 320, 326, 335, 352
SNMPv1/v2	141
SNTP	71
SNTP client	72
SNTP server	76
Software backup	31
Software update	31
Spanning tree protocol	280
SSH server	124
Switch dump	377
Syslog	341
System information	329
System log	382
System monitor	338
System time	67
<b>T</b>	
Technical questions	415
Telnet server	122, 313
Temperature	20, 307, 321
Threshold values network load	194
Time-Sensitive Networking	214
Topology discovery	370
Training courses	415
Transparent clock	91
Trap destination	326
Traps	52, 57, 59, 149, 281, 297, 306, 311, 320, 326, 335, 352
Trust mode	235
TSN Configuration	214
TSN Gate Control List	220, 222
TSN SDU	218
Twisted pair	347
<b>U</b>	
Unaware mode	191
User administration	109
Utilization	54

---

<b>V</b>	
Virtual local area network .....	242
VLAN .....	26, 242
VLAN configuration .....	245
VLAN ports .....	247
VLAN unaware mode .....	191
<b>W</b>	
Watchdog .....	34, 38
Web server .....	127, 128
<b>Z</b>	
ZIP archive .....	377



## B Further support

### Technical questions

For technical questions, please contact any Hirschmann dealer in your area or Hirschmann directly.

You find the addresses of our partners on the Internet at [www.hirschmann.com](http://www.hirschmann.com).

A list of local telephone numbers and email addresses for technical support directly from Hirschmann is available at [hirschmann-support.belden.com](http://hirschmann-support.belden.com).

This site also includes a free of charge knowledge base and a software download section.

### Technical Documents

The current manuals and operating instructions for Hirschmann products are available at [doc.hirschmann.com](http://doc.hirschmann.com).

### Hirschmann Competence Center

The Hirschmann Competence Center is ahead of its competitors on three counts with its complete range of innovative services:

- ▶ Consulting incorporates comprehensive technical advice, from system evaluation through network planning to project planning.
- ▶ Training offers you an introduction to the basics, product briefing and user training with certification.  
You find the training courses on technology and products currently available at [www.hicomcenter.com](http://www.hicomcenter.com).
- ▶ Support ranges from the first installation through the standby service to maintenance concepts.

With the Hirschmann Competence Center, you decided against making any compromises. Our client-customized package leaves you free to choose the service components you want to use.



## C Readers' Comments

What is your opinion of this manual? We are constantly striving to provide as comprehensive a description of our product as possible, as well as important information to assist you in the operation of this product. Your comments and suggestions help us to further improve the quality of our documentation.

Your assessment of this manual:

	Very Good	Good	Satisfactory	Mediocre	Poor
Precise description	<input type="radio"/>	<input type="radio"/>	<input type="radio"/>	<input type="radio"/>	<input type="radio"/>
Readability	<input type="radio"/>	<input type="radio"/>	<input type="radio"/>	<input type="radio"/>	<input type="radio"/>
Understandability	<input type="radio"/>	<input type="radio"/>	<input type="radio"/>	<input type="radio"/>	<input type="radio"/>
Examples	<input type="radio"/>	<input type="radio"/>	<input type="radio"/>	<input type="radio"/>	<input type="radio"/>
Structure	<input type="radio"/>	<input type="radio"/>	<input type="radio"/>	<input type="radio"/>	<input type="radio"/>
Comprehensive	<input type="radio"/>	<input type="radio"/>	<input type="radio"/>	<input type="radio"/>	<input type="radio"/>
Graphics	<input type="radio"/>	<input type="radio"/>	<input type="radio"/>	<input type="radio"/>	<input type="radio"/>
Drawings	<input type="radio"/>	<input type="radio"/>	<input type="radio"/>	<input type="radio"/>	<input type="radio"/>
Tables	<input type="radio"/>	<input type="radio"/>	<input type="radio"/>	<input type="radio"/>	<input type="radio"/>

Did you discover any errors in this manual?  
If so, on what page?

---



---



---



---



---



---



---



---



---

Suggestions for improvement and additional information:

---



---



---



---

General comments:

---

---

---

---

Sender:

---

Company / Department:

---

Name / Telephone number:

---

Street:

---

Zip code / City:

---

E-mail:

---

Date / Signature:

---

Dear User,

Please fill out and return this page

- ▶ as a fax to the number +49 (0)7127/14-1600 or
- ▶ per mail to  
Hirschmann Automation and Control GmbH  
Department 01RD-NT  
Stuttgarter Str. 45-51  
72654 Neckartenzlingen  
Germany



**HIRSCHMANN**

---

A **BELDEN** BRAND



**HIRSCHMANN**

A **BELDEN** BRAND

# User Manual

## Configuration

### Rail Switch Power Enhanced

### HiOS-2S

The naming of copyrighted trademarks in this manual, even when not specially indicated, should not be taken to mean that these names may be considered as free in the sense of the trademark and tradename protection law and hence that they may be freely used by anyone.

© 2020 Hirschmann Automation and Control GmbH

Manuals and software are protected by copyright. All rights reserved. The copying, reproduction, translation, conversion into any electronic medium or machine scannable form is not permitted, either in whole or in part. An exception is the preparation of a backup copy of the software for your own use.

The performance features described here are binding only if they have been expressly agreed when the contract was made. This document was produced by Hirschmann Automation and Control GmbH according to the best of the company's knowledge. Hirschmann reserves the right to change the contents of this document without prior notice. Hirschmann can give no guarantee in respect of the correctness or accuracy of the information in this document.

Hirschmann can accept no responsibility for damages, resulting from the use of the network components or the associated operating software. In addition, we refer to the conditions of use specified in the license contract.

You can get the latest version of this manual on the Internet at the Hirschmann product site ([www.hirschmann.com](http://www.hirschmann.com)).

Hirschmann Automation and Control GmbH  
Stuttgarter Str. 45-51  
72654 Neckartenzlingen  
Germany

## Contents

	<b>Safety instructions</b> .....	9
	<b>About this Manual</b> .....	11
	<b>Key</b> .....	12
	<b>Replacing a faulty device</b> .....	13
<b>1</b>	<b>User interfaces</b> .....	15
1.1	Graphical User Interface .....	15
1.2	Command Line Interface .....	16
1.2.1	Preparing the data connection .....	16
1.2.2	Access to the Command Line Interface using Telnet .....	16
1.2.3	Access to the Command Line Interface using SSH (Secure Shell) .....	19
1.2.4	Access to the Command Line Interface using the serial interface .....	21
1.2.5	Mode-based command hierarchy .....	23
1.2.6	Executing the commands .....	27
1.2.7	Structure of a command .....	27
1.2.8	Examples of commands .....	30
1.2.9	Input prompt .....	31
1.2.10	Key combinations .....	32
1.2.11	Data entry elements .....	34
1.2.12	Use cases .....	35
1.2.13	Service Shell .....	36
1.3	System monitor .....	39
1.3.1	Functional scope .....	39
1.3.2	Starting the System Monitor .....	39
<b>2</b>	<b>Specifying the IP parameters</b> .....	41
2.1	IP parameter basics .....	41
2.1.1	IPv4 .....	41
2.2	Specifying the IP parameters using the Command Line Interface .....	45
2.2.1	IPv4 .....	45
2.3	Specifying the IP parameters using HiDiscovery .....	47
2.4	Specifying the IP parameters using the Graphical User Interface .....	49
2.4.1	IPv4 .....	49
2.5	Specifying the IP parameters using BOOTP .....	50
2.6	Specifying the IP parameters using DHCP .....	51
2.6.1	IPv4 .....	51
2.7	Management address conflict detection .....	53
2.7.1	Active and passive detection .....	53
<b>3</b>	<b>Access to the device</b> .....	55
3.1	Access roles .....	55
3.2	First login (Password change) .....	56
3.3	Authentication lists .....	57
3.3.1	Applications .....	57
3.3.2	Policies .....	57
3.3.3	Managing authentication lists .....	57
3.3.4	Adjust the settings .....	58

3.4	User management . . . . .	60
3.4.1	Access roles . . . . .	60
3.4.2	Managing user accounts . . . . .	62
3.4.3	Default setting . . . . .	62
3.4.4	Changing default passwords . . . . .	62
3.4.5	Setting up a new user account. . . . .	63
3.4.6	Deactivating the user account . . . . .	64
3.4.7	Adjusting policies for passwords . . . . .	65
3.5	SNMP access. . . . .	67
3.5.1	SNMPv1/v2 access . . . . .	67
3.5.2	SNMPv3 access. . . . .	67
<b>4</b>	<b>Managing configuration profiles . . . . .</b>	<b>69</b>
4.1	Detecting changed settings . . . . .	69
4.1.1	Volatile memory ( RAM ) and non-volatile memory ( NVM ). . . . .	69
4.1.2	External memory (ACA) and non-volatile memory ( NVM ). . . . .	70
4.2	Saving the settings. . . . .	71
4.2.1	Saving the configuration profile in the device. . . . .	71
4.2.2	Saving the configuration profile in the external memory . . . . .	73
4.2.3	Backup the configuration profile on a remote server . . . . .	73
4.2.4	Exporting a configuration profile. . . . .	74
4.3	Loading settings . . . . .	76
4.3.1	Activating a configuration profile . . . . .	76
4.3.2	Loading the configuration profile from the external memory . . . . .	76
4.3.3	Importing a configuration profile. . . . .	78
4.4	Reset the device to the factory defaults. . . . .	81
4.4.1	Using the Graphical User Interface or Command Line Interface . . . . .	81
4.4.2	Using the System Monitor . . . . .	81
<b>5</b>	<b>Loading software updates. . . . .</b>	<b>83</b>
5.1	Software update from the PC. . . . .	83
5.2	Software update from a server. . . . .	84
5.3	Software update from the external memory. . . . .	85
5.3.1	Manually—initiated by the administrator . . . . .	85
5.3.2	Automatically—initiated by the device . . . . .	85
5.4	Loading a previous software version . . . . .	87
<b>6</b>	<b>Configuring the ports . . . . .</b>	<b>89</b>
6.1	Enabling/disabling the port. . . . .	89
6.2	Selecting the operating mode . . . . .	90
<b>7</b>	<b>Assistance in the protection from unauthorized access . . . . .</b>	<b>91</b>
7.1	Changing the SNMPv1/v2 community . . . . .	91
7.2	Disabling SNMPv1/v2 . . . . .	92
7.3	Disabling HTTP . . . . .	93
7.4	Disabling Telnet . . . . .	94
7.5	Disabling the HiDiscovery access . . . . .	95
7.6	Activating the IP access restriction . . . . .	96
7.7	Adjusting the session timeouts. . . . .	98
7.8	Deactivating the unused modules . . . . .	100

<b>8</b>	<b>Controlling the data traffic</b>	101
8.1	Helping protect against unauthorized access	101
8.2	ACL	103
8.2.1	Creating and editing IPv4 rules	104
8.2.2	Creating and configuring an IP ACL using the Command Line Interface	105
8.2.3	Creating and editing MAC rules	106
8.2.4	Creating and configuring a MAC ACL using the Command Line Interface	106
8.2.5	Assigning ACLs to a port or VLAN	107
<b>9</b>	<b>Synchronizing the system time in the network</b>	109
9.1	Basic settings	109
9.1.1	Setting the time	109
9.1.2	Automatic daylight saving time changeover	111
9.2	SNTP	112
9.2.1	Preparation	113
9.2.2	Defining settings of the SNTP client	114
9.2.3	Specifying SNTP server settings	115
9.3	PTP	116
9.3.1	Types of clocks	116
9.3.2	Best Master Clock algorithm	117
9.3.3	Delay measurement	117
9.3.4	PTP domains	118
9.3.5	Using PTP	118
<b>10</b>	<b>Network load control</b>	119
10.1	Direct packet distribution	119
10.1.1	Learning MAC addresses	119
10.1.2	Aging of learned MAC addresses	119
10.1.3	Static address entries	119
10.2	Multicasts	122
10.2.1	Example of a Multicast application	122
10.2.2	IGMP snooping	122
10.3	Rate limiter	127
10.4	QoS/Priority	128
10.4.1	Description of prioritization	128
10.4.2	Handling of received priority information	129
10.4.3	VLAN tagging	129
10.4.4	IP ToS (Type of Service)	130
10.4.5	Handling of traffic classes	131
10.4.6	Queue management	132
10.4.7	Management prioritization	134
10.4.8	Setting prioritization	134
10.5	Flow control	139
10.5.1	Halfduplex or fullduplex link	139
10.5.2	Setting up the Flow Control	140
<b>11</b>	<b>Planning data streams for TSN</b>	141
11.1	Explanation of terms	141
11.2	Underlying facts	142
11.3	Propagation delay	143
11.4	Bridge delay	144
11.4.1	Reception delay	144
11.4.2	Transmission delay	145



11.5	Example . . . . .	146
11.5.1	Time calculation . . . . .	146
11.5.2	Set up the devices . . . . .	149
<b>12</b>	<b>VLANs</b> . . . . .	<b>153</b>
12.1	Examples of VLANs . . . . .	153
12.1.1	Example 1 . . . . .	154
12.1.2	Example 2 . . . . .	157
12.2	Guest VLAN / Unauthenticated VLAN . . . . .	162
12.3	RADIUS VLAN assignment . . . . .	164
12.4	Creating a Voice VLAN . . . . .	165
12.5	VLAN unaware mode . . . . .	166
<b>13</b>	<b>Redundancy</b> . . . . .	<b>167</b>
13.1	Network Topology vs. Redundancy Protocols . . . . .	167
13.1.1	Network topologies . . . . .	167
13.1.2	Redundancy Protocols . . . . .	168
13.1.3	Combinations of Redundancies . . . . .	169
13.2	Media Redundancy Protocol (MRP) . . . . .	170
13.2.1	Network Structure . . . . .	170
13.2.2	Reconfiguration time . . . . .	171
13.2.3	Advanced mode . . . . .	171
13.2.4	Prerequisites for MRP . . . . .	171
13.2.5	Example Configuration . . . . .	172
13.3	Parallel Redundancy Protocol (PRP) (depends on hardware) . . . . .	177
13.3.1	Implementation . . . . .	177
13.3.2	LRE functionality . . . . .	178
13.3.3	PRP Network Structure . . . . .	179
13.3.4	Connecting RedBoxes and DANPs to a PRP network . . . . .	179
13.3.5	Example Configuration . . . . .	180
13.4	High-availability Seamless Redundancy (HSR) (depends on hardware) . . . . .	183
13.4.1	Implementation . . . . .	183
13.4.2	HSR Network Structure . . . . .	184
13.5	Device Level Ring (DLR) . . . . .	191
13.5.1	Device Roles . . . . .	191
13.5.2	Error Detection . . . . .	193
13.5.3	Neighbor Check process . . . . .	194
13.5.4	Sign On Process . . . . .	195
13.5.5	Example Configuration . . . . .	196
13.6	Spanning Tree . . . . .	198
13.6.1	Basics . . . . .	198
13.6.2	Rules for Creating the Tree Structure . . . . .	201
13.6.3	Examples . . . . .	204
13.7	The Rapid Spanning Tree Protocol . . . . .	207
13.7.1	Port roles . . . . .	207
13.7.2	Port states . . . . .	208
13.7.3	Spanning Tree Priority Vector . . . . .	209
13.7.4	Fast reconfiguration . . . . .	209
13.7.5	STP compatibility mode . . . . .	209
13.7.6	Configuring the device . . . . .	210
13.7.7	Guards . . . . .	212
13.7.8	RSTP over HSR . . . . .	215

13.8	Link Aggregation	217
13.8.1	Methods of Operation	217
13.8.2	Link Aggregation Example	218
13.9	Link Backup	219
13.9.1	Fail Back Description	219
13.9.2	Example Configuration	219
<b>14</b>	<b>Operation diagnosis</b>	<b>221</b>
14.1	Sending SNMP traps	221
14.1.1	List of SNMP traps	222
14.1.2	SNMP traps for configuration activity	223
14.1.3	SNMP trap setting	223
14.1.4	ICMP messaging	223
14.2	Monitoring the Device Status	224
14.2.1	Events which can be monitored	224
14.2.2	Configuring the Device Status	225
14.2.3	Displaying the Device Status	226
14.3	Security Status	228
14.3.1	Events which can be monitored	228
14.3.2	Configuring the Security Status	229
14.3.3	Displaying the Security Status	231
14.4	Out-of-Band signaling	232
14.4.1	Controlling the Signal contact	232
14.4.2	Monitoring the Device and Security Statuses	233
14.5	Port status indication	236
14.6	Port event counter	237
14.6.1	Detecting non-matching duplex modes	237
14.7	Auto-Disable	239
14.8	Displaying the SFP status	241
14.9	Topology discovery	242
14.9.1	Displaying the Topology discovery results	242
14.9.2	LLDP-Med	243
14.10	Detecting loops	244
14.11	Reports	245
14.11.1	Global settings	245
14.11.2	Syslog	247
14.11.3	System Log	248
14.11.4	Audit Trail	248
14.12	Network analysis with TCPdump	250
14.13	Monitoring the data traffic	251
14.13.1	Port Mirroring	251
14.14	Self-test	253
14.15	Copper cable test	255
<b>15</b>	<b>Advanced functions of the device</b>	<b>257</b>
15.1	Using the device as a DHCP server	257
15.1.1	IP Addresses assigned per port or per VLAN	257
15.1.2	DHCP server static IP address example	258
15.1.3	DHCP server dynamic IP address range example	259
15.2	DHCP L2 Relay	260
15.2.1	Circuit and Remote IDs	260
15.2.2	DHCP L2 Relay configuration	261

15.3	MRP-IEEE	263
15.3.1	MRP operation	263
15.3.2	MRP timers	263
15.3.3	MMRP	264
15.3.4	MVRP	265
<b>16</b>	<b>Industry Protocols</b>	<b>269</b>
16.1	IEC 61850/MMS	270
16.1.1	Switch model for IEC 61850	270
16.1.2	Integration into a Control System	271
16.2	Modbus TCP	273
16.2.1	Client/Server Modbus TCP/IP Mode	273
16.2.2	Supported Functions and Memory Mapping	273
16.2.3	Example Configuration	276
16.3	EtherNet/IP	278
16.3.1	Integration into a Control System	278
16.3.2	EtherNet/IP Entity Parameters	280
16.4	PROFINET	297
16.4.1	Integration into a Control System	299
16.4.2	PROFINET Parameter	304
<b>A</b>	<b>Setting up the configuration environment</b>	<b>311</b>
A.1	Setting up a DHCP/BOOTP server	311
A.2	Setting up a DHCP server with Option 82	315
A.3	Preparing access via SSH	318
A.3.1	Generating a key in the device	318
A.3.2	Loading your own key onto the device	318
A.3.3	Preparing the SSH client program	319
A.4	HTTPS certificate	321
A.4.1	HTTPS certificate management	321
A.4.2	Access through HTTPS	322
<b>B</b>	<b>Appendix</b>	<b>323</b>
B.1	Literature references	323
B.2	Maintenance	324
B.3	Management Information Base (MIB)	325
B.4	List of RFCs	327
B.5	Underlying IEEE Standards	329
B.6	Underlying IEC Norms	330
B.7	Underlying ANSI Norms	331
B.8	Technical Data	332
B.9	Copyright of integrated Software	333
B.10	Abbreviations used	334
<b>C</b>	<b>Index</b>	<b>335</b>
<b>D</b>	<b>Further support</b>	<b>343</b>
<b>E</b>	<b>Readers' Comments</b>	<b>344</b>

## Safety instructions

### **WARNING**

#### **UNCONTROLLED MACHINE ACTIONS**

To avoid uncontrolled machine actions caused by data loss, configure all the data transmission devices individually.

Before you start any machine which is controlled via data transmission, be sure to complete the configuration of all data transmission devices.

**Failure to follow these instructions can result in death, serious injury, or equipment damage.**



---

## About this Manual

The “Configuration” user manual contains the information you need to start operating the device. It takes you step by step from the first startup operation through to the basic settings for operation in your environment.

The “Installation” user manual contains a device description, safety instructions, a description of the display, and the other information that you need to install the device.

The “Graphical User Interface” reference manual contains detailed information on using the graphical user interface to operate the individual functions of the device.

The “Command Line Interface” reference manual contains detailed information on using the Command Line Interface to operate the individual functions of the device.

The Industrial HiVision Network Management software provides you with additional options for smooth configuration and monitoring:

- ▶ Auto-topology discovery
- ▶ Browser interface
- ▶ Client/server structure
- ▶ Event handling
- ▶ Event log
- ▶ Simultaneous configuration of multiple devices
- ▶ Graphical user interface with network layout
- ▶ SNMP/OPC gateway

## Key

The designations used in this manual have the following meanings:

▶	List
□	Work step
<a href="#">Link</a>	Cross-reference with link
<b>Note:</b>	A note emphasizes a significant fact or draws your attention to a dependency.
<code>Courier</code>	Representation of a CLI command or field contents in the graphical user interface

 Execution in the Graphical User Interface

 Execution in the Command Line Interface

---

## Replacing a faulty device

The device provides the following plug-and-play solutions for replacing a faulty device with a device of the same type:

- ▶ The new device loads the configuration profile of the replaced device from the external memory. See [“Loading the configuration profile from the external memory” on page 76](#).
- ▶ The new device gets its IP address using DHCP *Option 82*. See [“DHCP L2 Relay” on page 260](#). See [“Setting up a DHCP server with Option 82” on page 315](#).

With each solution, upon reboot, the new device gets the same IP settings that the replaced device had.

- ▶ For accessing the device management using HTTPS, the device uses a digital certificate. You have the option to import your own certificate to the device. See [“HTTPS certificate management” on page 321](#).
- ▶ For accessing the device management using SSH, the device uses an RSA host key. You have the option to import your own host key in PEM format to the device. See [“Loading your own key onto the device” on page 318](#).





# 1 User interfaces

The device lets you specify the settings of the device using the following user interfaces.

Table 1: User interfaces for accessing the device management

User interface	Can be reached through ...	Prerequisite
Graphical User Interface	Ethernet (In-Band)	Web browser
Command Line Interface	Ethernet (In-Band) Serial interface (Out-of-Band)	Terminal emulation software
System monitor	Serial interface (Out-of-Band)	Terminal emulation software

## 1.1 Graphical User Interface

### System requirements

To open the Graphical User Interface, you need the desktop version of a web browser with HTML5 support.

**Note:** Third-party software such as web browsers validate certificates based on criteria such as their expiration date and current cryptographic parameter recommendations. Old certificates can cause errors for example, when they expire or cryptographic recommendations change. To solve validation conflicts with third-party software, transfer your own up-to-date certificate onto the device or regenerate the certificate with the latest firmware.

### Starting the Graphical User Interface

The prerequisite for starting the Graphical User Interface is that the IP parameters are configured in the device. See [“Specifying the IP parameters” on page 41](#).

Perform the following steps:

- Start your web browser.
- Type the IP address of the device in the address field of the web browser.  
Use the following form: `https://xxx.xxx.xxx.xxx`  
The web browser sets up the connection to the device and displays the login dialog.
- When you want to change the language of the Graphical User Interface, click the appropriate link in the top right corner of the login dialog.
- Enter the user name.
- Enter the password.
- Click the [Login](#) button.  
The web browser displays the Graphical User Interface.

## 1.2 Command Line Interface

The Command Line Interface enables you to use the functions of the device through a local or remote connection.

The Command Line Interface provides IT specialists with a familiar environment for configuring IT devices. As an experienced user or administrator, you have knowledge about the basics and about using Hirschmann devices.

### 1.2.1 Preparing the data connection

Information for assembling and starting up your device can be found in the “Installation” user manual.

- Connect the device with the network. The prerequisite for a successful data connection is the correct setting of the network parameters.

You can access the user interface of the Command Line Interface for example, with the freeware program *PuTTY*.

This program is provided on the product CD.

- Install the *PuTTY* program on your computer.

### 1.2.2 Access to the Command Line Interface using Telnet

#### Telnet connection using Windows

Telnet is only installed as standard in Windows versions before Windows Vista.

Perform the following steps:

- Start the *Command Prompt* program on your computer.
- Enter the command `telnet <IP_address>`.

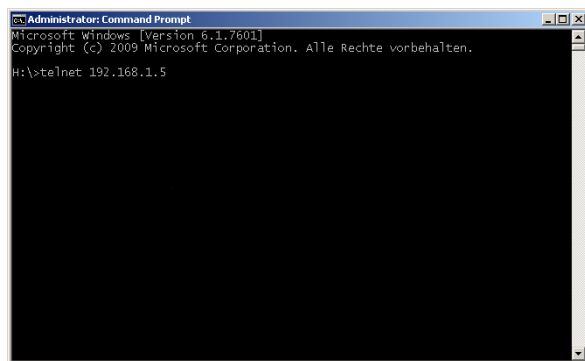

Figure 1: *Command Prompt*: Setting up the Telnet connection to the device

## Telnet connection using PuTTY

Perform the following steps:

- Start the *PuTTY* program on your computer.

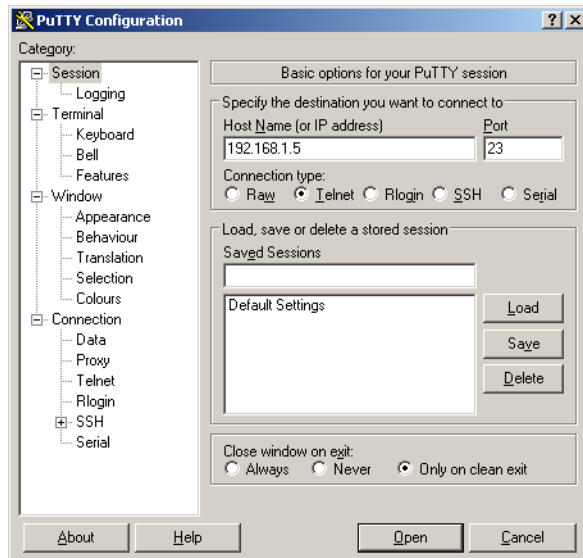

Figure 2: *PuTTY* input screen

- In the *Host Name (or IP address)* field you enter the IP address of your device.  
The IP address consists of 4 decimal numbers with values from 0 to 255. The 4 decimal numbers are separated by points.
- To select the connection type, select the *Telnet* radio button in the *Connection type* option list.
- Click the *Open* button to set up the data connection to your device.  
The Command Line Interface appears on the screen with a window for entering the user name.  
The device enables up to 5 users to have access to the Command Line Interface at the same time.

**Note:** This device is a security-relevant product. Change the password during the first startup procedure.

Perform the following steps:

- Enter the user name.  
The default user name is *admin*.
- Press the <Enter> key.

- Enter the password.  
The default password is `private`.
- Press the <Enter> key.

---

Copyright (c) 2011-2020 Hirschmann Automation and Control GmbH

All rights reserved

RSPE20 Release 8.6

(Build date 2019-02-05 19:17)

System Name : RSPE-ECE555F69780  
Management IP : 192.168.1.5  
Subnet Mask : 255.255.255.0  
Base MAC : EC:E5:55:01:02:03  
System Time : 2020-01-01 17:39:01

NOTE: Enter '?' for Command Help. Command help displays all options  
that are valid for the particular mode.  
For the syntax of a particular command form, please  
consult the documentation.

RSPE>

---

*Figure 3: Start screen of the Command Line Interface*

### 1.2.3 Access to the Command Line Interface using SSH (Secure Shell)

In the following example we use the *PuTTY* program. Another option to access your device using SSH is the OpenSSH Suite.

Perform the following steps:

- Start the *PuTTY* program on your computer.

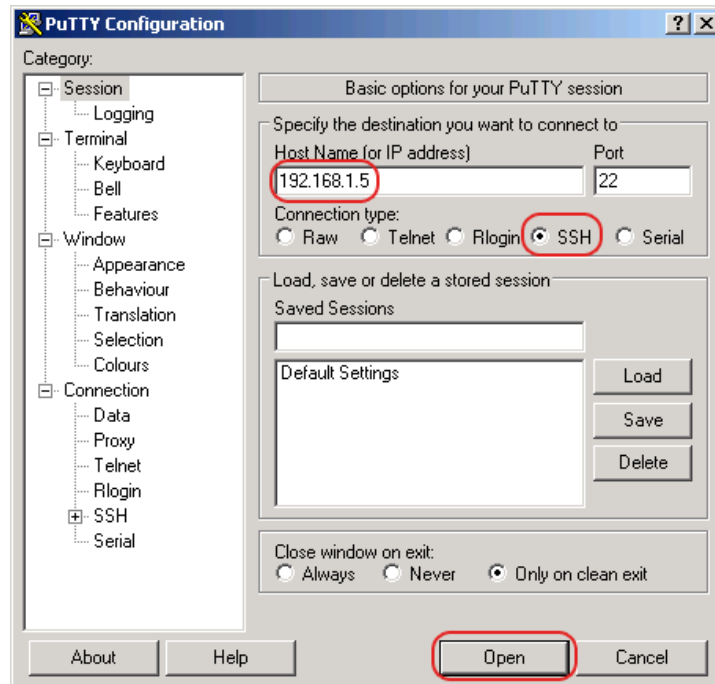

Figure 4: *PuTTY* input screen

- In the *Host Name (or IP address)* field you enter the IP address of your device. The IP address consists of 4 decimal numbers with values from 0 to 255. The 4 decimal numbers are separated by points.
- To specify the connection type, select the *SSH* radio button in the *Connection type* option list. After selecting and setting the required parameters, the device enables you to set up the data connection using SSH.

- Click the [Open](#) button to set up the data connection to your device.  
Depending on the device and the time at which SSH was configured, setting up the connection takes up to a minute.  
When you first log in, towards the end of the connection setup, the *PuTTY* program displays a security alert message and lets you check the fingerprint of the key.



Figure 5: Security alert prompt for the fingerprint

- Check the fingerprint.  
This helps protect yourself from unwelcome guests.
- When the fingerprint matches the fingerprint of the device key, click the [Yes](#) button.  
The device lets you display the finger prints of the device keys with the command `show ssh` or in the *Device Security > Management Access > Server* dialog, *SSH* tab.  
The Command Line Interface appears on the screen with a window for entering the user name.  
The device enables up to 5 users to have access to the Command Line Interface at the same time.
- Enter the user name.  
The default user name is [admin](#).
- Press the <Enter> key.
- Enter the password.  
The default password is [private](#).
- Press the <Enter> key.

**Note:** This device is a security-relevant product. Change the password during the first startup procedure.

---

```
login as: admin
admin@192.168.1.5's password:
```

```
Copyright (c) 2011-2020 Hirschmann Automation and Control GmbH
```

```
All rights reserved
```

```
RSPE20 Release 8.6
```

```
(Build date 2019-02-05 19:17)
```

```
System Name   : RSPE-ECE555F69780
Management IP : 192.168.1.5
Subnet Mask   : 255.255.255.0
Base MAC      : EC:E5:55:01:02:03
System Time   : 2020-01-01 17:39:01
```

```
NOTE: Enter '?' for Command Help.  Command help displays all options
      that are valid for the particular mode.
      For the syntax of a particular command form, please
      consult the documentation.
```

```
RSPE>
```

---

Figure 6: Start screen of the Command Line Interface

## 1.2.4 Access to the Command Line Interface using the serial interface

The serial interface is used to locally connect an external network management station (VT100 terminal or PC with terminal emulation). The interface lets you set up a data connection to the Command Line Interface and to the system monitor.

VT 100 terminal settings	
Speed	9600 bit/s
Data	8 bit
Stopbit	1 bit
Handshake	off
Parity	none



Perform the following steps:

- Connect the device to a terminal using the serial interface. Alternatively connect the device to a COM port of your PC using terminal emulation based on VT100 and press any key.
- Alternatively you set up the serial data connection to the device with the serial interface using the *PuTTY* program. Press the <Enter> key.

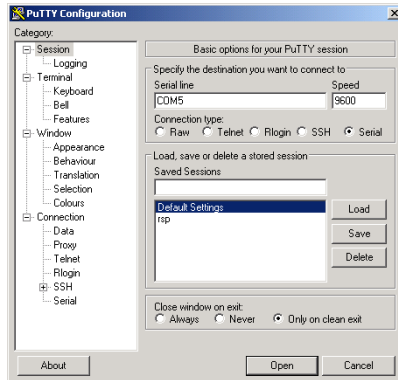

Figure 7: Serial data connection with the serial interface using the *PuTTY* program

- Press any key on your terminal keyboard a number of times until the login screen indicates the CLI mode.
- Enter the user name.  
The default user name is *admin*.
- Press the <Enter> key.
- Enter the password.  
The default password is *private*.
- Press the <Enter> key.

**Note:** This device is a security-relevant product. Change the password during the first startup procedure.

---

Copyright (c) 2011-2020 Hirschmann Automation and Control GmbH

All rights reserved

RSPE20 Release 8.6

(Build date 2019-02-05 19:17)

System Name : RSPE-ECE555F69780  
Management IP : 192.168.1.5  
Subnet Mask : 255.255.255.0  
Base MAC : EC:E5:55:01:02:03  
System Time : 2020-01-01 17:39:01

NOTE: Enter '?' for Command Help. Command help displays all options  
that are valid for the particular mode.  
For the syntax of a particular command form, please  
consult the documentation.

RSPE>

---

*Figure 8: Start screen of the Command Line Interface*

### 1.2.5 Mode-based command hierarchy

In the Command Line Interface, the commands are grouped in the related modes, according to the type of the command. Every command mode supports specific Hirschmann software commands.

The commands available to you as a user depend on your privilege level (administrator, operator, guest, auditor). They also depend on the mode in which you are currently working. When you switch to a specific mode, the commands of the mode are available to you.

The User Exec mode commands are an exception. The Command Line Interface also enables you to execute these commands in the Privileged Exec mode.

The following figure displays the modes of the Command Line Interface.

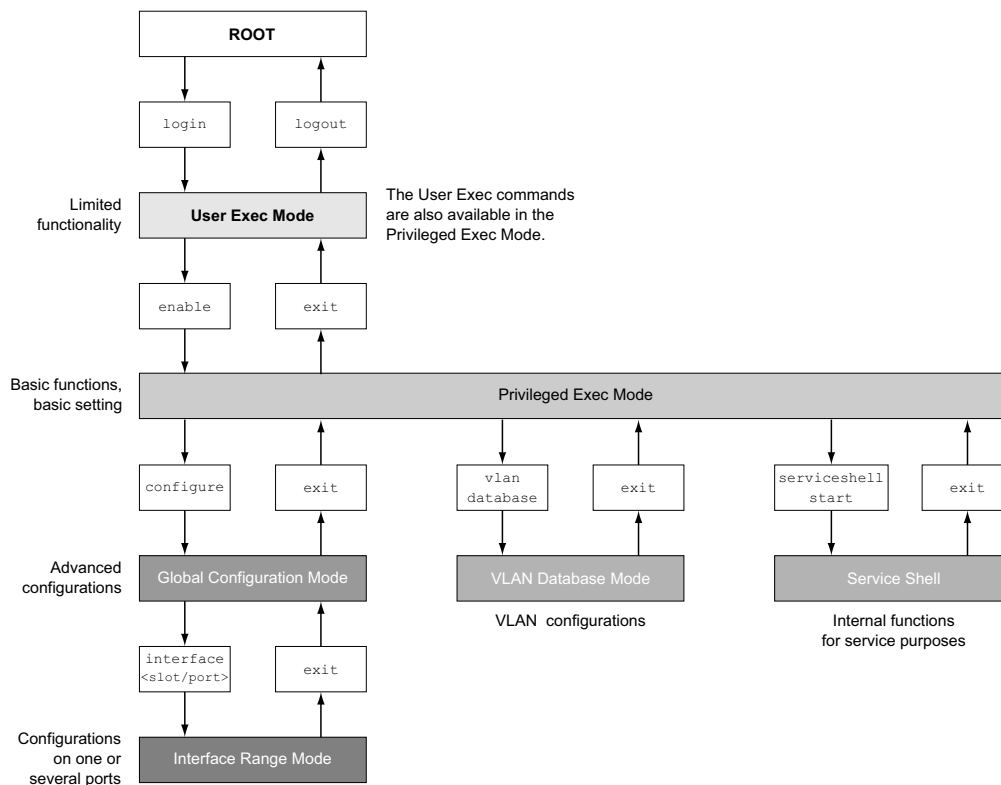

Figure 9: Structure of the Command Line Interface

The Command Line Interface supports, depending on the user level, the following modes:

- ▶ **User Exec mode**  
When you log in with the Command Line Interface, you enter the User Exec mode. The User Exec mode contains a limited range of commands.  
Command prompt: (RSPE) >
- ▶ **Privileged Exec mode**  
To access the entire range of commands, you enter the Privileged Exec mode. If you log in as a privileged user, then you are able to enter the Privileged Exec mode. In the Privileged Exec mode, you are able to execute the User Exec mode commands, too.  
Command prompt: (RSPE) #
- ▶ **VLAN mode**  
The VLAN mode contains VLAN-related commands.  
Command prompt: (RSPE) (VLAN) #
- ▶ **Service Shell**  
The Service Shell is for service purposes only.  
Command prompt: /mnt/fastpath #
- ▶ **Global Config mode**  
The Global Config mode lets you perform modifications to the current configuration. This mode groups general setup commands.  
Command prompt: (RSPE) (config) #
- ▶ **Interface Range mode**  
The commands in the Interface Range mode affect a specific port, a selected group of multiple ports or all port of the device. The commands modify a value or switch a function on/off on one or more specific ports.

- All physical ports in the device  
**Command prompt:** (RSPE) ((interface) all)#  
**Example:** When you switch from the Global Config mode to the Interface Range mode, the command prompt changes as follows:  
 (RSPE) (config)#interface all  
 (RSPE) ((Interface)all)#
- A single port on one interface  
**Command prompt:** (RSPE) (interface <slot/port>)#  
**Example:** When you switch from the Global Config mode to the Interface Range mode, the command prompt changes as follows:  
 (RSPE) (config)#interface 2/1  
 (RSPE) (interface 2/1)#
- A range of ports on one interface  
**Command prompt:** (RSPE) (interface <interface range> )#  
**Example:** When you switch from the Global Config mode to the Interface Range mode, the command prompt changes as follows:  
 (RSPE) (config)#interface 1/2-1/4  
 (RSPE) ((Interface)1/2-1/4)#
- A list of single ports  
**Command prompt:** (RSPE) (interface <interface list>)#  
**Example:** When you switch from the Global Config mode to the Interface Range mode, the command prompt changes as follows:  
 (RSPE) (config)#interface 1/2,1/4,1/5  
 (RSPE) ((Interface)1/2,1/4,1/5)#
- A list of port ranges and single ports  
**Command prompt:** (RSPE) (interface <complex range>)#  
**Example:** When you switch from the Global Config mode to the Interface Range mode, the command prompt changes as follows:  
 (RSPE) (config)#interface 1/2-1/4,1/6-1/9  
 (RSPE) ((Interface)1/2-1/4,1/6-1/9)

The following table displays the command modes, the command prompts (input request characters) visible in the corresponding mode, and the option with which you quit this mode.

Table 2: Command modes

Command mode	Access method	Quit or start next mode
User Exec mode	First access level. Perform basic tasks and list system information.	To quit you enter <code>logout</code> : (RSPE) >logout Are you sure (Y/N) ?y
Privileged Exec mode	From the User Exec mode, you enter the command <code>enable</code> : (RSPE) >enable (RSPE) #	To quit the Privileged Exec mode and return to the User Exec mode, you enter <code>exit</code> : (RSPE) #exit (RSPE) >

Table 2: Command modes

Command mode	Access method	Quit or start next mode
VLAN mode	From the Privileged Exec mode, you enter the command <code>vlan database</code> : (RSPE) #vlan database (RSPE) (Vlan)#	To end the VLAN mode and return to the Privileged Exec mode, you enter <code>exit</code> or press <b>Ctrl Z</b> . (RSPE) (Vlan)#exit (RSPE) #
Global Config mode	From the Privileged Exec mode, you enter the command <code>configure</code> : (RSPE) #configure (RSPE) (config)# From the User Exec mode, you enter the command <code>enable</code> , and then in Privileged Exec mode, enter the command <code>Configure</code> : (RSPE) >enable (RSPE) #configure (RSPE) (config)#	To quit the Global Config mode and return to the Privileged Exec mode, you enter <code>exit</code> : (RSPE) (config)#exit (RSPE) # To then quit the Privileged Exec mode and return to the User Exec mode, you enter <code>exit</code> again: (RSPE) #exit (RSPE) >
Interface Range mode	From the Global Config mode you enter the command <code>interface</code> {all <slot/port> <interface range> <interface list> <complex range>}. (RSPE) (config)#interface <slot/port> (RSPE) (interface slot/port)#	To quit the Interface Range mode and return to the Global Config mode, you enter <code>exit</code> . To return to the Privileged Exec mode, you press <b>Ctrl Z</b> . (RSPE) (interface slot/port)#exit (RSPE) #

When you enter a question mark (?) after the prompt, the Command Line Interface displays a list of the available commands and a short description of the commands.

```
(RSPE)>
cli          Set the CLI preferences.
enable      Turn on privileged commands.
help        Display help for various special keys.
history     Show a list of previously run commands.
logout      Exit this session.
ping        Send ICMP echo packets to a specified IP address.
show        Display device options and settings.
telnet      Establish a telnet connection to a remote host.

(RSPE)>
```

Figure 10: Commands in the User Exec mode

## 1.2.6 Executing the commands

### Syntax analysis

When you log in with the Command Line Interface, you enter the User Exec mode. The Command Line Interface displays the prompt `(RSPE)>` on the screen.

When you enter a command and press the <Enter> key, the Command Line Interface starts the syntax analysis. The Command Line Interface searches the command tree for the desired command.

When the command is outside the Command Line Interface command range, a message informs you of the detected error.

Example:

You want to execute the `show system info` command, but enter `info` without `f` and press the <Enter> key.

The Command Line Interface then displays a message:

```
(RSPE)>show system ino  
  
Error: Invalid command 'ino'
```

### Command tree

The commands in the Command Line Interface are organized in a tree structure. The commands, and where applicable the related parameters, branch down until the command is completely defined and therefore executable. The Command Line Interface checks the input. When you entered the command and the parameters correctly and completely, you execute the command with the <Enter> key.

After you entered the command and the required parameters, the other parameters entered are treated as optional parameters. When one of the parameters is unknown, the Command Line Interface displays a syntax message.

The command tree branches for the required parameters until the required parameters have reached the last branch in the structure.

With optional parameters, the command tree branches until the required parameters and the optional parameters have reached the last branch in the structure.

## 1.2.7 Structure of a command

This section describes the syntax, conventions and terminology, and uses examples to represent them.

## Format of commands

Most of the commands include parameters.

When the command parameter is missing, the Command Line Interface informs you about the detection of an incorrect command syntax.

This manual displays the commands and parameters in the `Courier` font.

## Parameters

The sequence of the parameters is relevant for the correct syntax of a command.

Parameters are required values, optional values, selections, or a combination of these things. The representation indicates the type of the parameter.

*Table 3: Parameter and command syntax*

<code>&lt;command&gt;</code>	Commands in pointed brackets ( <code>&lt;&gt;</code> ) are obligatory.
<code>[command]</code>	Commands in square brackets ( <code>[]</code> ) are optional.
<code>&lt;parameter&gt;</code>	Parameters in pointed brackets ( <code>&lt;&gt;</code> ) are obligatory.
<code>[parameter]</code>	Parameters in square brackets ( <code>[]</code> ) are optional.
<code>...</code>	An ellipsis (3 points in sequence without spaces) after an element indicates that you can repeat the element.
<code>[Choice1   Choice2]</code>	A vertical line enclosed in brackets indicates a selection option. Select one value. Elements separated by a vertical line and enclosed in square brackets indicate an optional selection (Option1 or Option2 or no selection).
<code>{list}</code>	Curved brackets ( <code>{}</code> ) indicate that a parameter is to be selected from a list of options.
<code>{Choice1   Choice2}</code>	Elements separated by a vertical line and enclosed in curved brackets ( <code>{}</code> ) indicate an obligatory selection option (option1 or option2).
<code>[param1 {Choice1   Choice2}]</code>	Displays an optional parameter that contains an obligatory selection.
<code>&lt;a.b.c.d&gt;</code>	Small letters are wild cards. You enter parameters with the notation a.b.c.d with decimal points (for example IP addresses)
<code>&lt;cr&gt;</code>	You press the <code>&lt;Enter&gt;</code> key to create a line break (carriage return).

The following list displays the possible parameter values within the Command Line Interface:

Table 4: Parameter values in the Command Line Interface

Value	Description
IP address	This parameter represents a valid IPv4 address. The address consists of 4 decimal numbers with values from 0 to 255. The 4 decimal numbers are separated by a decimal point. The IP address <code>0.0.0.0</code> is a valid entry.
MAC address	This parameter represents a valid MAC address. The address consists of 6 hexadecimal numbers with values from 00 to FF. The numbers are separated by a colon, for example, <code>00:F6:29:B2:81:40</code> .
string	User-defined text with a length in the specified range, for example a maximum of 32 characters.
character string	Use double quotation marks to indicate a character string, for example <code>"System name with space character"</code> .
number	Whole integer in the specified range, for example <code>0..999999</code> .
date	Date in format <code>YYYY-MM-DD</code> .
time	Time in format <code>HH:MM:SS</code> .

## Network addresses

Network addresses are a requirement for establishing a data connection to a remote work station, a server, or another network. You distinguish between IP addresses and MAC addresses.

The IP address is an address allocated by the network administrator. The IP address is unique in one network area.

The MAC addresses are assigned by the hardware manufacturer. MAC addresses are unique worldwide.

The following table displays the representation and the range of the address types:

Table 5: Format and range of network addresses

Address Type	Format	Range	Example
IP Address	nnn.nnn.nnn.nnn	nnn: 0 to 255 (decimal)	192.168.11.110
MAC Address	mm:mm:mm:mm:m m:mm	mm: 00 to ff (hexadecimal number pairs)	A7:C9:89:DD:A9:B3

## Strings

A string is indicated by quotation marks. For example, `"System name with space character"`. Space characters are not valid user-defined strings. You enter a space character in a parameter between quotation marks.

Example:

```
*(RSPE)#cli prompt Device name
Error: Invalid command 'name'
```



```
*(RSPE)#cli prompt 'Device name'  
  
*(Device name)#
```

## 1.2.8 Examples of commands

### Example 1: clear arp-table-switch

Command for clearing the ARP table of the management agent (cache).

`clear arp-table-switch` is the command name. The command is executable without any other parameters by pressing the <Enter> key.

### Example 2: radius server timeout

Command to configure the RADIUS server timeout value.

```
(RSPE) (config)#radius server timeout  
<1..30> Timeout in seconds (default: 5).
```

`radius server timeout` is the command name.

The parameter is required. The value range is `1..30`.

### Example 3: radius server auth modify <1..8>

Command to set the parameters for RADIUS authentication server 1.

```
(RSPE) (config)#radius server auth modify 1  
[name] RADIUS authentication server name.  
[port] RADIUS authentication server port.  
(default: 1812).  
[msgauth] Enable or disable the message authenticator  
attribute for this server.  
[primary] Configure the primary RADIUS server.  
[status] Enable or disable a RADIUS authentication  
server entry.  
[secret] Configure the shared secret for the RADIUS  
authentication server.  
[encrypted] Configure the encrypted shared secret.  
<cr> Press Enter to execute the command.
```

`radius server auth modify` is the command name.

The parameter `<1..8>` (RADIUS server index) is required. The value range is `1..8` (integer).

The parameters `[name]`, `[port]`, `[msgauth]`, `[primary]`, `[status]`, `[secret]` and `[encrypted]` are optional.

## 1.2.9 Input prompt

### Command mode

With the input prompt, the Command Line Interface displays which of the three modes you are in:

- ▶ (RSPE) >  
User Exec mode
- ▶ (RSPE) #  
Privileged Exec mode
- ▶ (RSPE) (config)#  
Global Config mode
- ▶ (RSPE) (Vlan)#  
VLAN Database mode
- ▶ (RSPE) ((Interface)all)#  
Interface Range mode / All ports of the device
- ▶ (RSPE) ((Interface)2/1)#  
Interface Range mode / A single port on one interface
- ▶ (RSPE) ((Interface)1/2-1/4)#  
Interface Range mode / A range of ports on one interface
- ▶ (RSPE) ((Interface)1/2,1/4,1/5)#  
Interface Range mode / A list of single ports
- ▶ (RSPE) ((Interface)1/1-1/2,1/4-1/6)#  
Interface Range mode / A list of port ranges and single ports

### Asterisk, pound sign and exclamation point

- ▶ Asterisk \*  
An asterisk \* in the first or second position of the input prompt displays you that the settings in the volatile memory and the settings in the non-volatile memory are different. In your configuration, the device has detected modifications which have not been saved.  
\*(RSPE) >
- ▶ Pound sign #  
A pound sign # at the beginning of the input prompt displays you that the boot parameters and the parameters during the boot phase are different.  
\*(#) (RSPE) >
- ▶ Exclamation point !  
An exclamation point ! at the beginning of the input prompt displays: the password for the `user` or `admin` user account corresponds with the default setting.  
!(RSPE) >

### Wildcards

The device lets you change the command line prompt.

The Command Line Interface supports the following wildcards:

Table 6: Using wildcards within the Command Line Interface input prompt

Wildcard	Description
%d	System date
%t	System time

Table 6: Using wildcards within the Command Line Interface input prompt

Wildcard	Description
%i	IP address of the device
%m	MAC address of the device
%p	Product name of the device

---

```
!(RSPE)>enable

!(RSPE)#cli prompt %i

!192.168.1.5#cli prompt (RSPE)%d

!* (RSPE)2020-01-27#cli prompt (RSPE)%d%t

!* (RSPE)2020-01-2715:45:41#cli prompt %m

!*AA:BB:CC:DD:EE:FF#
```

### 1.2.10 Key combinations

The following key combinations make it easier for you to work with the Command Line Interface:

Table 7: Key combinations in the Command Line Interface

Key combination	Description
<CTRL> + <H>, <Backspace>	Delete previous character
<CTRL> + <A>	Go to beginning of line
<CTRL> + <E>	Go to end of line
<CTRL> + <F>	Go forward one character
<CTRL> + <B>	Go backward one character
<CTRL> + <D>	Delete current character
<CTRL> + <U>, <X>	Delete to beginning of line
<CTRL> + <K>	Delete to end of line
<CTRL> + <W>	Delete previous word
<CTRL> + <P>	Go to previous line in history buffer
<CTRL> + <R>	Rewrite or paste the line
<CTRL> + <N>	Go to next line in history buffer
<CTRL> + <Z>	Return to root command prompt
<CTRL> + <G>	Aborts running tcpdump session
<Tab>, <SPACE>	Command line completion
Exit	Go to next lower command prompt
<?>	List choices

The Help command displays the possible key combinations in Command Line Interface on the screen:

---

```
(RSPE) #help

HELP:
Special keys:

Ctrl-H, BkSp delete previous character
Ctrl-A .... go to beginning of line
Ctrl-E .... go to end of line
Ctrl-F .... go forward one character
Ctrl-B .... go backward one character
Ctrl-D .... delete current character
Ctrl-U, X .. delete to beginning of line
Ctrl-K .... delete to end of line
Ctrl-W .... delete previous word
Ctrl-P .... go to previous line in history buffer
Ctrl-R .... rewrites or pastes the line
Ctrl-N .... go to next line in history buffer
Ctrl-Z .... return to root command prompt
Ctrl-G .... aborts running tcpdump session
Tab, <SPACE> command-line completion
Exit .... go to next lower command prompt
? .... list choices

(RSPE) #
```

---

*Figure 11: Listing the key combinations with the Help command*

### 1.2.11 Data entry elements

#### Command completion

To simplify typing commands, the Command Line Interface lets you use command completion (Tab Completion). Thus you are able to abbreviate key words.

- ▶ Type in the beginning of a keyword. When the characters entered identify a keyword, the Command Line Interface completes the keyword after you press the tab key or the space key. When there is more than one option for completion, enter the letter or the letters necessary for uniquely identifying the keyword. Press the tab key or the space key again. After that, the system completes the command or parameter.
- ▶ When you make a non-unique entry and press <Tab> or <Space> twice, the Command Line Interface provides you with a list of options.
- ▶ On a non-unique entry and pressing <Tab> or <Space>, the Command Line Interface completes the command up to the end of the uniqueness. When several commands exist and you press <Tab> or <Space> again, the Command Line Interface provides you with a list of options.

Example:

```
(RSPE) (Config)#lo
(RSPE) (Config)#log
logging logout
```

When you enter `lo` and <Tab> or <Space>, the Command Line Interface completes the command up to the end of the uniqueness to `log`.

When you press <Tab> or <Space> again, the Command Line Interface provides you with a list of options (`logging logout`).

#### Possible commands/parameters

You can obtain a list of the commands or the possible parameters by entering `help` or `?`, for example by entering `(RSPE) >show ?`

When you enter the command displayed, you get a list of the parameters available for the command `show`.

When you enter the command without space character in front of the question mark, the device displays the help text for the command itself:

```
!*(RSPE) (Config)#show?
```

```
show          Display device options and settings.
```

## 1.2.12 Use cases

### Saving the Configuration

To help ensure that your password settings and your other configuration changes are kept after the device is reset or after an interruption of the voltage supply, you save the configuration. To do this, perform the following steps:

- Enter `enable` to switch to the Privileged Exec mode.
- Enter the following command:
 

```
save [profile]
```
- Execute the command by pressing the <Enter> key.

### Syntax of the „radius server auth add“ command

Use this command to add a RADIUS authentication server.

- ▶ Mode: [Global Config](#) mode
- ▶ Privilege Level: Administrator
- ▶ Format: `radius server auth add <1..8> ip <a.b.c.d> [name <string>] [port <1..65535>]`
  - `[name]`: RADIUS authentication server name.
  - `[port]`: RADIUS authentication server port (default value: `1813`).

Parameter	Meaning	Possible values
<1..8>	RADIUS server index.	1..8
<a.b.c.d>	RADIUS accounting server IP address.	IP address
<string>	Enter a user-defined text, max. 32 characters.	
<1..65535>	Enter port number between 1 and 65535.	1..65535

Mode and Privilege Level:

- ▶ The prerequisite for executing the command: You are in the Global Config mode. See [“Mode-based command hierarchy” on page 23](#).
- ▶ The prerequisite for executing the command: You have the Administrator access role.

Syntax of commands and parameters: See [“Structure of a command” on page 27](#).

Examples for executable commands:

- ▶ `radius server auth add 1 ip 192.168.30.40`
- ▶ `radius server auth add 2 ip 192.168.40.50 name radiusserver2`
- ▶ `radius server auth add 3 ip 192.168.50.60 port 1813`
- ▶ `radius server auth add 4 ip 192.168.60.70 name radiusserver4 port 1814`

### 1.2.13 Service Shell

The Service Shell is for service purposes only.

The Service Shell lets users have access to internal functions of the device. When you need assistance with your device, the service personnel use the Service Shell to monitor internal conditions for example, the switch or CPU registers.

Do not execute internal functions without service technician instructions. Executing internal functions such as deleting the content of the non-volatile memory (NVM) **possibly leads to inoperability of your device.**

#### Start the Service Shell

The prerequisite is that you are in User Exec mode: (RSPE) >

Perform the following steps:

- Enter `enable` and press the <Enter> key.  
To reduce the effort when typing:
  - Enter `e` and press the <Tab> key.
- Enter `serviceshell start` and press the <Enter> key.  
To reduce the effort when typing:
  - Enter `ser` and press the <Tab> key.
  - Enter `s` and press the <Tab> key.

---

```
!RSPE >enable

!*RSPE #serviceshell start
WARNING! The service shell offers advanced diagnostics and functions.
Proceed only when instructed by a service technician.

You can return to the previous mode using the 'exit' command.

BusyBox v1.31.0 (2019-09-05 12:17:22 UTC) built-in shell (ash)
Enter 'help' for a list of built-in commands.

!/mnt/fastpath #
```

---

#### Working with the Service Shell

When the Service Shell is active, the timeout of the Command Line Interface is inactive. To help prevent configuration inconsistencies, end the Service Shell before any other user starts transferring a new configuration to the device.

### Display the Service Shell commands

The prerequisite is that you already started the Service Shell.

Perform the following steps:

- Enter `help` and press the <Enter> key.

---

```
/mnt/fastpath # help
Built-in commands:
-----
. : [ [[ alias bg break cd chdir command continue echo eval exec
exit export false fg getopts hash help history jobs kill let
local pwd read readonly return set shift source test times trap
true type ulimit umask unalias unset wait
/mnt/fastpath #
```

---

### End the Service Shell

Perform the following steps:

- Enter `exit` and press the <Enter> key.

### Deactivate the Service Shell permanently in the device

When you deactivate the Service Shell, you are still able to configure the device. However, you limit the service personnel's possibilities to perform system diagnostics. The service technician will no longer be able to access internal functions of your device.

The deactivation is irreversible. The Service Shell remains permanently deactivated. **In order to reactivate the Service Shell, the device requires disassembly by the manufacturer.**

The prerequisites are:

- The Service Shell is not started.
- You are in User Exec mode: (RSPE) >

Perform the following steps:

- Enter `enable` and press the <Enter> key.  
To reduce the effort when typing:
  - Enter `e` and press the <Tab> key.
- Enter `serviceshell deactivate` and press the <Enter> key.  
To reduce the effort when typing:



- Enter `ser` and press the <Tab> key.
- Enter `dea` and press the <Tab> key.
- This step is irreversible!**  
Press the <Y> key.

---

```
!RSPE >enable

!*RSPE #serviceshell deactivate
Notice: If you continue, then the Service Shell is permanently deactivated.
This step is irreversible!
For details, refer to the Configuration Manual.
Are you sure (Y/N) ?
```

---

## 1.3 System monitor

The System Monitor lets you set basic operating parameters before starting the operating system.

### 1.3.1 Functional scope

In the System Monitor, you carry out the following tasks, for example:

- ▶ Managing the operating system and verifying the software image
- ▶ Updating the operating system
- ▶ Starting the operating system
- ▶ Deleting configuration profiles, resetting the device to the factory defaults
- ▶ Checking boot code information

### 1.3.2 Starting the System Monitor

Prerequisite:

- ▶ Terminal cable for connecting the device to your PC (available as an optional accessory).
- ▶ PC with VT100 terminal emulation (such as the [PuTTY](#) program) or serial terminal

Perform the following steps:

- Use the terminal cable to connect the serial interface of the device with the COM port of the PC.
- Start the VT100 terminal emulation on the PC.
- Specify the following transmission parameters:

VT 100 terminal settings	
Speed	9600 bit/s
Data	8 bit
Stopbit	1 bit
Handshake	off
Parity	none

- Set up a connection to the device.
- Turn on the device. When the device is already on, reboot it.  
The screen displays the following message after rebooting:  
Press <1> to enter System Monitor 1.
- Press the <1> key within 3 seconds.  
The device starts the System Monitor. The screen displays the following view:

---

```
System Monitor 1
(Selected OS: ...-8.6 (2019-02-05 19:17))

1 Manage operating system
2 Update operating system
3 Start selected operating system
4 Manage configurations
5 Show boot code information
q End (reset and reboot)

sysMon1>
```

---

Figure 12: System Monitor 1 screen display

- Select a menu item by entering the number.
- To leave a submenu and return to the main menu of System Monitor 1, press the <ESC> key.

## 2 Specifying the IP parameters

When you install the device for the first time, enter the IP parameters.

The device provides the following options for entering the IP parameters during the first installation:

- ▶ Entry using the Command Line Interface.  
When you preconfigure your device outside its operating environment, or restore the network access (“In-Band”) to the device, choose this “Out-of-Band” method.
- ▶ Entry using the HiDiscovery protocol.  
When you have a previously installed network device or you have another Ethernet connection between your PC and the device, you choose this “In-Band” method.
- ▶ Configuration using the external memory.  
When you are replacing a device with a device of the same type and have already saved the configuration in the external memory, you choose this method.
- ▶ Using BOOTP.  
To configure the installed device using BOOTP, you choose this “In-Band” method. You need a BOOTP server for this method. The BOOTP server assigns the configuration data to the device using its MAC address. The DHCP mode is the default mode for the configuration data reference.
- ▶ Configuration using DHCP.  
To configure the installed device using DHCP, you choose this “In-Band” method. You need a DHCP server for this method. The DHCP server assigns the configuration data to the device using its MAC address or its system name.
- ▶ Configuration using the Graphical User Interface.  
When the device already has an IP address and is reachable using the network, the Graphical User Interface provides you with another option for configuring the IP parameters.

## 2.1 IP parameter basics

### 2.1.1 IPv4

#### IP address

The IP addresses consist of 4 bytes. Write these 4 bytes in decimal notation, separated by a decimal point.

RFC 1340 written in 1992, defines 5 IP Address classes.

Table 8: IP address classes

Class	Network address	Host address	Address range
A	1 Byte	3 Bytes	0.0.0.0 to 127.255.255.255
B	2 Bytes	2 Bytes	128.0.0.0 to 191.255.255.255
C	3 Bytes	1 Byte	192.0.0.0 to 223.255.255.255
D			224.0.0.0 to 239.255.255.255
E			240.0.0.0 to 255.255.255.255

The first byte of an IP address is the network address. The worldwide leading regulatory board for assigning network addresses is the IANA ("Internet Assigned Numbers Authority"). When you require an IP address block, contact your Internet Service Provider (ISP). Your ISP contacts their local higher-level organization to reserve an IP address block:

- ▶ APNIC (Asia Pacific Network Information Center)  
Asia/Pacific Region
- ▶ ARIN (American Registry for Internet Numbers)  
Americas and Sub-Sahara Africa
- ▶ LACNIC (Regional Latin-American and Caribbean IP Address Registry)  
Latin America and some Caribbean Islands
- ▶ RIPE NCC (Réseaux IP Européens)  
Europe and Surrounding Regions

0	Net ID - 7 bits	Host ID - 24 bits	Class A
1 0	Net ID - 14 bits	Host ID - 16 bits	Class B
1 1 0	Net ID - 21 bits	Host ID - 8 bits	Class C
1 1 1 0	Multicast Group ID - 28 bits		Class D
1 1 1 1	reserved for future use - 28 bits		Class E

Figure 13: Bit representation of the IP address

When the first bit of an IP address is a zero, it belongs to class A for example, the first octet is less than 128.

When the first bit of an IP address is a one and the second bit is a zero, it belongs to class B for example, the first octet is between 128 and 191.

When the first 2 bits of an IP address are a one, it belongs to class C for example, the first octet is higher than 191.

Assigning the host address (host ID) is the responsibility of the network operator. The network operator alone is responsible for the uniqueness of the assigned IP addresses.

### Netmask

Routers and Gateways subdivide large networks into subnetworks. The netmask assigns the IP addresses of the individual devices to a particular subnetwork.

You perform subnetwork division using the netmask in much the same way as the division of the network addresses (net id) into classes A to C.

Set the bits of the host address (host id) that represent the mask to one. Set the remaining host address bits to zero (see the following examples).

Example of a subnet mask:

Decimal notation  
255.255.192.0

Binary notation  
11111111.11111111.11000000.00000000

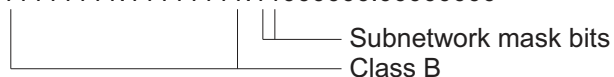

Example of applying the subnet mask to IP addresses for subnetwork assignment:

Decimal notation

129.218.65.17

└─── 128 < 129 191 > Class B

Binary notation

10000001.11011010.01000001.00010001

└─── Subnetwork 1  
└─── Network address

Decimal notation

129.218.129.17

└─── 128 < 129 191 > Class B

Binary notation

10000001.11011010.10000001.00010001

└─── Subnetwork 2  
└─── Network address

### Example of how the netmask is used

In a large network it is possible that Gateways and routers separate the management agent from its network management station. How does addressing work in such a case?

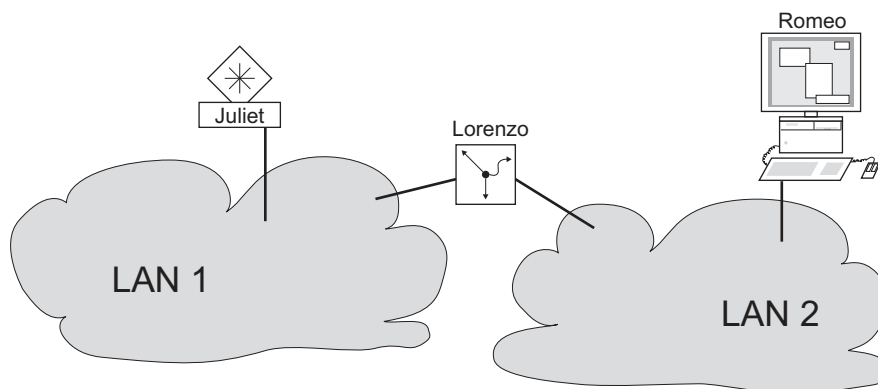

Figure 14: The management agent is separated from its network management station by a router

The network management station “Romeo” wants to send data to the management agent “Juliet”. Romeo knows Juliet's IP address and also knows that the router “Lorenzo” knows the way to Juliet.

Romeo therefore puts his message in an envelope and writes Juliet's IP address as the destination address; for the source address he writes his own IP address on the envelope.

Romeo then places this envelope in a second one with Lorenzo's MAC address as the destination and his own MAC address as the source. This process is comparable to going from Layer 3 to Layer 2 of the ISO/OSI base reference model.

Finally, Romeo puts the entire data packet into the mailbox which is comparable to going from Layer 2 to Layer 1, that means to sending the data packet over the Ethernet.

Lorenzo receives the letter, removes the outer envelope and recognizes from the inner envelope that the letter is meant for Juliet. He places the inner envelope in a new outer envelope and searches his address list (the ARP table) for Juliet's MAC address; he writes her MAC address on the outer envelope as the destination address and his own MAC address as the source address. He then places the entire data packet in the mail box.

Juliet receives the letter and removes the outer envelope. She finds the inner envelope with Romeo's IP address. Opening the inner envelope and reading its contents corresponds to transferring the message to the higher protocol layers of the ISO/OSI layer model.

Juliet would now like to send a reply to Romeo. She places her reply in an envelope with Romeo's IP address as destination and her own IP address as source. But where is she to send the answer? For she did not receive Romeo's MAC address. It was lost, because Lorenzo replaced the outer envelope.

In the MIB, Juliet finds Lorenzo listed under the variable `hmNetGatewayIPAddr` as a means of communicating with Romeo. She therefore puts the envelope with the IP addresses in a further envelope with Lorenzo's MAC destination address.

The letter now travels back to Romeo via Lorenzo, the same way the first letter traveled from Romeo to Juliet.

### Classless Inter-Domain Routing

Class C with a maximum of 254 addresses was too small, and class B with a maximum of 65534 addresses was too large for most users. Resulting in an ineffective usage of the available class B addresses.

Class D contains reserved Multicast addresses. Class E is for experimental purposes. A non-participating Gateway ignores experimental datagrams with these destination addresses.

Since 1993, RFC 1519 has been using Classless Inter-Domain Routing (CIDR) to provide a solution. CIDR overcomes these class boundaries and supports classless address ranges.

With CIDR, you enter the number of bits that designate the IP address range. You represent the IP address range in binary form and count the mask bits that designate the netmask. The mask bits equal the number of bits used for the subnet in a given IP address range.

Example:

IP address, decimal	Network mask, decimal	IP address, binary
192.168.112.1	255.255.255.128	11000000 10101000 01110000 00000001
192.168.112.127		11000000 10101000 01110000 01111111
		----- 25 mask bits -----

CIDR notation: 192.168.112.0/25  
|----- Mask bits

The term "supernetting" refers to combing a number of class C address ranges. Supernetting enables you to subdivide class B address ranges to a fine degree.

## 2.2 Specifying the IP parameters using the Command Line Interface

### 2.2.1 IPv4

There are the following methods you enter the IP parameters:

- ▶ BOOTP/DHCP
- ▶ HiDiscovery protocol
- ▶ External memory
- ▶ Command Line Interface using the serial connection

The device lets you specify the IP parameters using the HiDiscovery protocol or using the Command Line Interface over the serial interface.

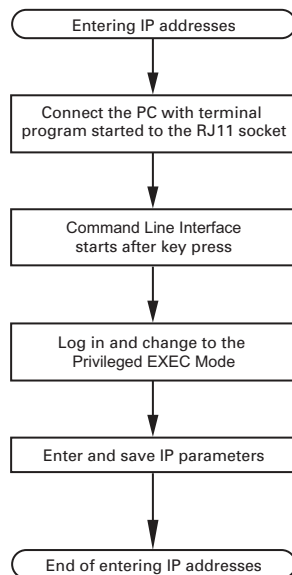

Figure 15: Flow chart for entering IP addresses

**Note:** If a terminal or PC with terminal emulation is unavailable in the vicinity of the installation location, you can configure the device at your own workstation, then take it to its final installation location.



Perform the following steps:

- Set up a connection to the device.  
The start screen appears.

```
NOTE: Enter '?' for Command Help. Command help displays all opt
that are valid for the particular mode.
For the syntax of a particular command form, please
consult the documentation.

! ( ) >
```

- Deactivate DHCP.
- Enter the IP parameters.
  - ▶ Local IP address  
In the default setting, the local IP address is 0.0.0.0.
  - ▶ Netmask  
When you divided your network into subnetworks, and these are identified with a netmask, enter the netmask here. In the default setting, the local netmask is 0.0.0.0.
  - ▶ IP address of the Gateway.  
This entry is only required, in cases where the device and the network management station or TFTP server are located in different subnetworks ([see on page 43 “Example of how the netmask is used”](#)).  
Specify the IP address of the Gateway between the subnetwork with the device and the path to the network management station.  
In the default setting, the IP address is 0.0.0.0.
- Save the configuration specified using `copy config running-config nvM`.

<code>enable</code>	Change to the Privileged EXEC mode.
<code>network protocol none</code>	Deactivating DHCP.
<code>network parms 10.0.1.23 255.255.255.0</code>	Assign the device the IP address 10.0.1.23 and the netmask 255.255.255.0. You have the option of also assigning a Gateway address.
<code>copy config running-config nvM</code>	Save the current settings in the non-volatile memory (nvM) in the “selected” configuration profile.

After entering the IP parameters, you easily configure the device using the Graphical User Interface.

## 2.3 Specifying the IP parameters using HiDiscovery

The HiDiscovery protocol enables you to assign IP parameters to the device using the Ethernet.

You easily configure other parameters using the Graphical User Interface.

Install the HiDiscovery software on your PC. The software is on the product DVD supplied with the device.

Perform the following steps:

- To install it, you start the installation program on the DVD.
- Start the HiDiscovery program.

Id #	MAC Address	Writable	IP Address	Net Mask	Default Gateway	Product	Name
1	00:80:63:A4:CC:00	<input checked="" type="checkbox"/>	10.115.0.76	255.255.224.0	10.115.0.3		
2	00:80:63:C0:50:00	<input type="checkbox"/>	10.115.0.33	255.255.224.0	10.115.0.3		
3	00:80:63:A3:40:00	<input type="checkbox"/>	10.115.0.70	255.255.224.0	10.115.0.3		
4	00:80:63:98:14:00	<input type="checkbox"/>	10.115.0.17	255.255.224.0	10.115.0.3		
5	00:80:63:96:E4:00	<input type="checkbox"/>	0.0.0.0	0.0.0.0	0.0.0.0		
6	00:80:63:46:00:06	<input checked="" type="checkbox"/>	192.168.2.181	255.255.255.0	192.168.2.1		
7	00:80:63:A3:40:40	<input type="checkbox"/>	10.115.0.59	255.255.224.0	10.115.0.3		
8	00:80:63:A4:CC:40	<input type="checkbox"/>	10.115.0.81	255.255.224.0	10.115.0.3		
9	00:80:63:6E:38:4E	<input checked="" type="checkbox"/>	192.168.2.174	255.255.255.0	192.168.2.1		
10	00:80:63:1B:2A:61	<input checked="" type="checkbox"/>	192.168.2.170	255.255.255.0	192.168.2.1		
11	00:80:63:A3:40:80	<input type="checkbox"/>	10.115.0.66	255.255.224.0	10.115.0.3		
12	00:80:63:A4:CC:80	<input type="checkbox"/>	10.115.0.80	255.255.224.0	10.115.0.3		
13	00:80:63:61:AC:81	<input checked="" type="checkbox"/>	192.168.2.176	255.255.255.0	192.168.2.1		
14	00:80:63:98:10:95	<input type="checkbox"/>	10.115.0.22	255.255.224.0	10.115.0.3		
15	00:80:63:61:AC:AB	<input checked="" type="checkbox"/>	192.168.2.40	255.255.255.0	192.168.2.1		
16	00:80:63:3B:5C:BD	<input checked="" type="checkbox"/>	192.168.2.178	255.255.255.0	192.168.2.1		
17	00:80:63:A3:40:C0	<input type="checkbox"/>	10.115.0.72	255.255.224.0	10.115.0.3		
18	00:80:63:8F:2C:BE	<input type="checkbox"/>	10.115.0.40	255.255.224.0	10.115.0.3		
19	00:80:63:88:38:EC	<input checked="" type="checkbox"/>	192.168.110.92	255.255.255.0	0.0.0.0		
20	00:80:63:9B:11:00	<input type="checkbox"/>	10.115.0.35	255.255.224.0	10.115.0.3		
21	00:80:63:A4:CD:00	<input type="checkbox"/>	10.115.0.77	255.255.224.0	10.115.0.3		
22	00:80:63:99:41:08	<input type="checkbox"/>	10.115.0.13	255.255.224.0	10.115.0.3		
23	00:80:63:17:35:08	<input checked="" type="checkbox"/>	192.168.2.164	255.255.255.0	192.168.2.1		
24	00:80:63:44:19:2E	<input checked="" type="checkbox"/>	10.115.5.130	255.255.224.0	10.115.0.3		

Figure 16: HiDiscovery

When HiDiscovery is started, HiDiscovery automatically searches the network for those devices which support the HiDiscovery protocol.

HiDiscovery uses the first network interface found for the PC. When your computer has several network cards, you can select the one you desire in the HiDiscovery toolbar.

HiDiscovery displays a line for every device that responds to a HiDiscovery protocol inquiry.

HiDiscovery enables you to identify the devices displayed.

- Select a device line.
- To set the LEDs to flashing for the selected device, click the *Signal* button on the tool bar. To stop the flashing, click the *Signal* button again.
- By double-clicking a line, you open a window in which you specify the device name and the IP parameter.

Properties

MAC Address: 00:80:63:A3:40:00

Name: Power Unit 1 Switch 2

IP Configuration

IP Address: 10 . 115 . 0 . 70 Set Default ()

Net Mask: 255 . 255 . 224 . 0 Set Default ()

Default Gateway: 10 . 115 . 0 . 3 Set Default ()

Save As Default

OK Cancel

Figure 17: HiDiscovery – assigning IP parameters

**Note:** Disable the HiDiscovery function in the device, after you have assigned the IP parameters to the device.

**Note:** Save the settings so that you will still have the entries after a restart.

## 2.4 Specifying the IP parameters using the Graphical User Interface

### 2.4.1 IPv4

Perform the following steps:

- Open the *Basic Settings > Network > Global* dialog.

In this dialog you specify the VLAN in which the device management can be accessed and configure the HiDiscovery access.

- In the *VLAN ID* column you specify the VLAN in which the device management can be accessed over the network.

Note here that you can only access the device management using ports that are members of the relevant VLAN.

The *MAC address* field displays the MAC address of the device with which you access the device over the network.

- In the *HiDiscovery protocol v1/v2* frame you specify the settings for accessing the device using the HiDiscovery software.
- The HiDiscovery protocol lets you allocate an IP address to the device on the basis of its MAC address. Activate the HiDiscovery protocol if you want to allocate an IP address to the device from your PC with the HiDiscovery software.
- Open the *Basic Settings > Network > IPv4* dialog.

In this dialog you specify the source from which the device gets its IP parameters after starting.

- In the *Management interface* frame you first specify where the device gets its IP parameters from:
  - ▶ In the *BOOTP* mode, the configuration is using a BOOTP or DHCP server on the basis of the MAC address of the device.
  - ▶ In the *DHCP* mode, the configuration is using a DHCP server on the basis of the MAC address or the name of the device.
  - ▶ In the *Local* mode, the device uses the network parameters from the internal device memory.

**Note:** When you change the allocation mode of the IP address, the device activates the new mode immediately after you click the  button.

- If required, you enter the IP address, the netmask and the Gateway in the *IP parameter* frame.
- Save the changes temporarily. To do this, click the  button.

## 2.5 Specifying the IP parameters using BOOTP

With the *BOOTP* function activated the device sends a boot request message to the BOOTP server. The boot request message contains the Client ID configured in the *Basic Settings > Network > IPv4* dialog. The BOOTP server enters the Client ID into a database and assigns an IP address. The server answers with a boot reply message. The boot reply message contains the assigned IP address.

## 2.6 Specifying the IP parameters using DHCP

### 2.6.1 IPv4

The DHCP (Dynamic Host Configuration Protocol) is a further development of BOOTP, which it has replaced. The DHCP additionally lets the configuration of a DHCP client using a name instead of using the MAC address.

For the DHCP, this name is known as the “Client Identifier” in accordance with RFC 2131.

The device uses the name entered under sysName in the system group of the MIB II as the Client Identifier. You can change the system name using the Graphical User Interface (see dialog [Basic Settings > System](#)), the Command Line Interface or SNMP.

The device sends its system name to the DHCP server. The DHCP server then uses the system name to allocate an IP address as an alternative to the MAC address.

In addition to the IP address, the DHCP server sends

- ▶ the netmask
- ▶ the default Gateway (if available)
- ▶ the TFTP URL of the configuration file (if available).

The device applies the configuration data to the appropriate parameters. When the DHCP Server assigns the IP address, the device permanently saves the configuration data in non-volatile memory.

*Table 9: DHCP options which the device requests*

Options	Meaning
1	Subnet Mask
2	Time Offset
3	Router
4	Time server
12	Host Name
42	NTP server
61	Client Identifier
66	TFTP Server Name
67	Bootfile Name

The advantage of using DHCP instead of BOOTP is that the DHCP server can restrict the validity of the configuration parameters (“Lease”) to a specific time period (known as dynamic address allocation). Before this period (“Lease Duration”) elapses, the DHCP client can attempt to renew this lease. Alternatively, the client can negotiate a new lease. The DHCP server then allocates a random free address.

To help avoid this, DHCP servers provide the explicit configuration option of assigning a specific client the same IP address based on a unique hardware ID (known as static address allocation).

In the default setting, DHCP is activated. As long as DHCP is activated, the device attempts to obtain an IP address. When the device cannot find a DHCP server after restarting, it will not have an IP address. The [Basic Settings > Network > IPv4](#) dialog lets you activate or deactivate DHCP.

**Note:** When using Industrial HiVision network management, verify that DHCP allocates the original IP address to every device.

The appendix contains an example configuration of the BOOTP/DHCP-server.

Example of a DHCP-configuration file:

```
# /etc/dhcpd.conf for DHCP Daemon
#
subnet 10.1.112.0 netmask 255.255.240.0 {
option subnet-mask 255.255.240.0;
option routers 10.1.112.96;
}
#
# Host berta requests IP configuration
# with her MAC address
#
host berta {
hardware ethernet 00:80:63:08:65:42;
fixed-address 10.1.112.82;
}
#
# Host hugo requests IP configuration
# with his client identifier.
#
host hugo {
#
option dhcp-client-identifier "hugo";
option dhcp-client-identifier 00:68:75:67:6f;
fixed-address 10.1.112.83;
server-name "10.1.112.11";
filename "/agent/config.dat";
}
```

Lines beginning with the # character, contain comments.

The lines preceding the individually listed devices refer to settings that apply to the following device.

The fixed-address line assigns a permanent IP address to the device.

For further information, please refer to the DHCP server manual.

## 2.7 Management address conflict detection

You assign an IP address to the device using several different methods. This function helps the device detect IP address conflicts on a network after boot up and the device also checks periodically during operation. This function is described in RFC 5227.

When enabled, the device sends an SNMP trap informing you that it detected an IP address conflict.

The following list contains the default settings for this function:

- *Operation*: On
- *Detection mode*: active and passive
- *Send periodic ARP probes*: marked
- *Detection delay [ms]*: 200
- *Release delay [s]*: 15
- *Address protections*: 3
- *Protection interval [ms]*: 200
- *Send trap*: marked

### 2.7.1 Active and passive detection

Actively checking the network helps prevent the device from connecting to the network with a duplicate IP address. After connecting the device to a network or after configuring the IP address, the device immediately checks if its IP address exists within the network. To check the network for address conflicts, the device sends 4 ARP probes with the detection delay of 200 ms into the network. When the IP address exists, the device attempts to return to the previous configuration, and make another check after the configured release delay time.

When you disable active detection, the device sends 2 gratuitous APR announcements in 2 s intervals. Using the ARP announcements with passive detection enabled, the device polls the network to determine if there is an address conflict. After resolving an address conflict or after expired release delay time, the device reconnects to the network. Following 10 detected conflicts, when the configured release delay interval is less than 60 s, the device sets the release delay interval to 60 s.

After the device performs active detection or you disable the active detection function, with passive detection enabled the device listens on the network for other devices using the same IP address. When the device detects a duplicate IP address, it initially defends its address by employing the ACD mechanism in the passive detection mode and sends out gratuitous ARPs. The number of protections that the device sends and the protection interval are configurable. To resolve conflicts, if the remote device remains connected to the network, then the network interface of the local device disconnects from the network.

When a DHCP server assigns an IP address to the device and an address conflict occurs, the device returns a DHCP decline message.

The device uses the ARP probe method. This has the following advantages:

- ▶ ARP caches on other devices remain unchanged
- ▶ the method is robust through multiple ARP probe transmissions





## 3 Access to the device

### 3.1 Access roles

The device functions available to you as a user depend on your access role. When you are logged in with a specific access role, the functions of the access role are available to you.

The commands available to you as a user, also depend on the Command Line Interface mode in which you are currently working. See “Mode-based command hierarchy” on page 23.

The device offers the following access roles:

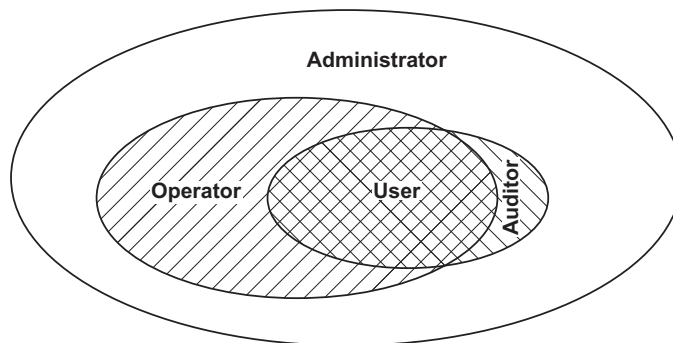

Table 10: Access roles and scope of user authorizations

Access role	User authorizations
User	Users logged in with the access role <code>User</code> are authorized to monitor the device.
Auditor	Users logged in with the access role <code>Auditor</code> are authorized to monitor the device and to save the log file in the <code>Diagnostics &gt; Report &gt; Audit Trail</code> dialog.
Operator	Users logged in with the access role <code>Operator</code> are authorized to monitor the device and to change the settings – with the exception of security settings for device access.
Administrator	Users logged in with the access role <code>Administrator</code> are authorized to monitor the device and to change the settings.
Unauthorized	Unauthorized users are blocked, and the device rejects the user login. Assign this value to temporarily lock the user account. If a detected error occurs during an access role change, then the device assigns this access role to the user account.

## 3.2 First login (Password change)

To help prevent undesired access to the device, it is imperative that you change the default password during initial setup.

Perform the following steps:

- Open the Graphical User Interface, the HiView application, or the Command Line Interface the first time you log in.
- Log in with the default password.  
The device prompts you to type in a new password.
- Type in your new password.  
To help increase security, choose a password that contains at least 8 characters which includes upper-case characters, lower-case characters, numerical digits, and special characters.
- When you log in with the Command Line Interface, the device prompts you to confirm your new password.
- Log in again with your new password.

**Note:** If you lost your password, then use the System Monitor to reset the password.

For further information see [hirschmann-support.belden.com](https://hirschmann-support.belden.com).

## 3.3 Authentication lists

When a user accesses the device using a specific connection, the device verifies the login credentials of the user in an authentication list which contains the policies that the device applies for authentication.

The prerequisite for a user's access to the device management is that at least one policy is assigned to the authentication list of the application through which access is performed.

### 3.3.1 Applications

The device provides an application for each type of connection through which someone accesses the device:

- ▶ Access to the Command Line Interface using a serial connection: [Console \(V.24\)](#)
- ▶ Access to the Command Line Interface using SSH: [SSH](#)
- ▶ Access to the Command Line Interface using Telnet: [Telnet](#)
- ▶ Access to the Graphical User Interface: [WebInterface](#)

The device also provides an application to control the access to the network from connected end devices using port-based access control: [8021x](#)

### 3.3.2 Policies

When a user logs in with valid login data, the device lets the user have access to its device management. The device authenticates the users using the following policies:

- ▶ User management of the device
- ▶ RADIUS

When the end device logs in with valid login data, the device lets the connected end devices have access to the network with the port-based access control according to IEEE 802.1X. The device authenticates the end devices using the following policies:

- ▶ RADIUS
- ▶ IAS (Integrated Authentication Server)

The device gives you the option of a fall-back solution. For this, you specify more than one policy in the authentication list. When authentication is unsuccessful using the current policy, the device applies the next specified policy.

### 3.3.3 Managing authentication lists

You manage the authentication lists in the Graphical User Interface or in the Command Line Interface. To do this, perform the following steps:

- Open the [Device Security > Authentication List](#) dialog.  
The dialog displays the authentication lists that are set up.

`show authlists` Displays the authentication lists that are set up.

- Deactivate the authentication list for those applications by means of which no access to the device is performed, for example `8021x`.

- In the *Active* column of the authentication list `defaultDot1x8021AuthList`, unmark the checkbox.
- Save the changes temporarily. To do this, click the  button.

`authlists disable defaultDot1x8021AuthList` Deactivates the authentication list `defaultDot1x8021AuthList`.

### 3.3.4 Adjust the settings

Example: Set up a separate authentication list for the application `WebInterface` which is by default included in the authentication list `defaultLoginAuthList`.

The device forwards authentication requests to a RADIUS server in the network. As a fall-back solution, the device authenticates users using the local user management. To do this, perform the following steps:

- Create an authentication list `loginGUI`.

- Open the *Device Security > Authentication List* dialog.
- Click the  button. The dialog displays the *Create* window.
- Enter a meaningful name in the *Name* field. In this example, enter the name `loginGUI`.
- Click the *Ok* button. The device adds a new table entry.

`enable` Change to the Privileged EXEC mode.  
`configure` Change to the Configuration mode.  
`authlists add loginGUI` Creates the authentication list `loginGUI`.

- Select the policies for the authentication list `loginGUI`.

- In the *Policy 1* column, select the value `radius`.
- In the *Policy 2* column, select the value `local`.
- In the *Policy 3* to *Policy 5* columns, select the value `reject` to help prevent further fall-back.
- In the *Active* column, mark the checkbox.
- Save the changes temporarily. To do this, click the  button.

```
authlists set-policy loginGUI radius
local reject reject reject

show authlists



authlists enable loginGUI
```

Assigns the policies `radius`, `local` and `reject` to the authentication list `loginGUI`.

Displays the authentication lists that are set up.

Activates the authentication list `loginGUI`.

- Assign an application to the authentication list `loginGUI`.

- In the *Device Security > Authentication List* dialog, highlight the authentication list `loginGUI`.
- Click the  button and then the *Allocate applications* item. The dialog displays the *Allocate applications* window.
- In the left column, highlight the application `WebInterface`.
- Click the  button. The right column now displays the application `WebInterface`.
- Click the *Ok* button. The dialog displays the updated settings:
  - The *Dedicated applications* column of authentication list `loginGUI` displays the application `WebInterface`.
  - The *Dedicated applications* column of authentication list `defaultLoginAuthList` does not display the application `WebInterface` anymore.
- Save the changes temporarily. To do this, click the  button.

```
show appllists

appllists set-authlist WebInterface
loginGUI
```

Displays the applications and the allocated lists.

Assigns the `loginGUI` application to the authentication list `WebInterface`.

## 3.4 User management

When a user logs in with valid login data, the device lets the user have access to its device management. The device authenticates the users either using the local user management or with a RADIUS server in the network. To get the device to use the user management, assign the `local` policy to an authentication list, see the [Device Security > Authentication List](#) dialog.

In the local user management, you manage the user accounts. One user account is usually allocated to each user.

### 3.4.1 Access roles

The device lets you use a role-based authorization model to specifically control the access to the device management. Users to whom a specific authorization profile is allocated are allowed to use commands and functions from the same authorization profile or a lower one.

The device uses the authorization profiles on every application with which the device management can be accessed.

Every user account is linked to an access role that regulates the access to the individual functions of the device. Depending on the planned activity for the respective user, you assign a pre-defined access role to the user. The device differentiates between the following access roles.

Table 11: Access roles for user accounts

Role	Description	Authorized for the following activities
Administrator	The user is authorized to monitor and administer the device.	All activities with read/write access, including the following activities reserved for an administrator: <ul style="list-style-type: none"> <li>▶ Add, modify or delete user accounts</li> <li>▶ Activate, deactivate or unlock user accounts</li> <li>▶ Change every password</li> <li>▶ Configure password management</li> <li>▶ Set or change system time</li> <li>▶ Load files to the device, for example device configurations, certificates or software images</li> <li>▶ Reset settings and security-related settings to the state on delivery</li> <li>▶ Configure RADIUS server and authentication lists</li> <li>▶ Apply scripts using the Command Line Interface</li> <li>▶ Enable/disable CLI logging and SNMP logging</li> <li>▶ External memory activation and deactivation</li> <li>▶ System monitor activation and deactivation</li> <li>▶ Enable/disable the services for the access to the device management (for example SNMP).</li> <li>▶ Configure access restrictions to the Graphical User Interface or the Command Line Interface based on the IP addresses</li> </ul>
Operator	The user is authorized to monitor and configure the device - with the exception of security-related settings.	All activities with read/write access, with the exception of the above-named activities, which are reserved for an administrator:
Auditor	The user is authorized to monitor the device and to save the log file in the <a href="#">Diagnostics &gt; Report &gt; Audit Trail</a> dialog.	Monitoring activities with read access.
Guest	The user is authorized to monitor the device - with the exception of security-related settings.	Monitoring activities with read access.
Unauthorized	No access to the device possible. <ul style="list-style-type: none"> <li>▶ As an administrator you assign this access role to temporarily lock a user account.</li> <li>▶ If an administrator assigns a different access role to the user account and an error occurs, then the device assigns this access role to the user account.</li> </ul>	No activities allowed.



### 3.4.2 Managing user accounts

You manage the user accounts in the Graphical User Interface or in the Command Line Interface. To do this, perform the following steps:

- Open the *Device Security > User Management* dialog.  
The dialog displays the user accounts that are set up.

`show users` Displays the user accounts that are set up.

### 3.4.3 Default setting

In the state on delivery, the user accounts `admin` and `user` are set up in the device.

Table 12: Default settings for the factory setting user accounts

Parameter	Default setting	
<i>User name</i>	<code>admin</code>	<code>user</code>
<i>Password</i>	<code>private</code>	<code>public</code>
<i>Role</i>	<code>administrator</code>	<code>guest</code>
<i>User locked</i>	<code>unmarked</code>	<code>unmarked</code>
<i>Policy check</i>	<code>unmarked</code>	<code>unmarked</code>
<i>SNMP auth type</i>	<code>hmacmd5</code>	<code>hmacmd5</code>
<i>SNMP encryption type</i>	<code>des</code>	<code>des</code>

Change the password for the `admin` user account before making the device available in the network.

### 3.4.4 Changing default passwords

To help prevent undesired access, change the password of the default user accounts. To do this, perform the following steps:

- Change the passwords for the `admin` and `user` user accounts.

- Open the *Device Security > User Management* dialog.  
The dialog displays the user accounts that are set up.
- To obtain a higher level of complexity for the password, mark the checkbox in the *Policy check* column.  
Before saving it, the device checks the password according to the policy specified in the *Password policy* frame.

**Note:** The password check can lead to a message in the *Security status* frame in the *Basic Settings > System* dialog. You specify the settings that cause this message in the *Basic Settings > System* dialog.

- Click the row of the relevant user account in the *Password* field. Enter a password of at least 6 characters.  
Up to 64 alphanumeric characters are allowed.
  - ▶ The device differentiates between upper and lower case.
  - ▶ The minimum length of the password is specified in the *Configuration* frame. The device constantly checks the minimum length of the password.
- Save the changes temporarily. To do this, click the  button.

<pre>enable configure users password-policy-check &lt;user&gt; enable</pre>	<p>Change to the Privileged EXEC mode.</p> <p>Change to the Configuration mode.</p> <p>Activates the checking of the password for the <i>&lt;user&gt;</i> user account based on the specified policy. In this way, you obtain a higher level of complexity for the password.</p>
<p><b>Note:</b> When you display the security status, the password check can lead to a message (<code>show security-status all</code>). You specify the settings that cause this message with the command <code>security-status monitor pwd-policy-inactive</code>.</p> <pre>users password &lt;user&gt; SECRET</pre>	<p>Specifies the password <i>SECRET</i> for the <i>&lt;user&gt;</i> user account. Enter at least 6 characters.</p>
<pre>save</pre>	<p>Save the settings in the non-volatile memory (<i>nvm</i>) in the “selected” configuration profile.</p>

### 3.4.5 Setting up a new user account

Allocate a separate user account to each user that accesses the device management. In this way you can specifically control the authorizations for the access.

In the following example, we will set up the user account for a *USER* user with the role *operator*. Users with the *operator* role are authorized to monitor and configure the device - with the exception of security-related settings. To do this, perform the following steps:

- Create a new user account.

- Open the *Device Security > User Management* dialog.
- Click the  button.  
The dialog displays the *Create* window.
- Enter the name in the *User name* field.  
In this example, we give the user account the name *USER*.
- Click the *Ok* button.
- To obtain a higher level of complexity for the password, mark the checkbox in the *Policy check* column.  
Before saving it, the device checks the password according to the policy specified in the *Password policy* frame.

- In the *Password* field, enter a password of at least 6 characters. Up to 64 alphanumeric characters are allowed.
  - ▶ The device differentiates between upper and lower case.
  - ▶ The minimum length of the password is specified in the *Configuration* frame. The device constantly checks the minimum length of the password.
- In the *Role* column, select the user role. In this example, we select the value *operator*.
- To activate the user account, mark the checkbox in the *Active* column.
- Save the changes temporarily. To do this, click the  button. The dialog displays the user accounts that are set up.

<code>enable</code>	Change to the Privileged EXEC mode.
<code>configure</code>	Change to the Configuration mode.
<code>users add USER</code>	Creates the <i>USER</i> user account.
<code>users password-policy-check USER enable</code>	Activates the checking of the password for the <i>USER</i> user account based on the specified policy. In this way, you obtain a higher level of complexity for the password.
<code>users password USER SECRET</code>	Specifies the password <i>SECRET</i> for the user account <i>USER</i> . Enter at least 6 characters.
<code>users access-role USER operator</code>	Assign the user role <i>operator</i> to the user account <i>USER</i> .
<code>users enable USER</code>	Activates the user account <i>USER</i> .
<code>show users</code>	Displays the user accounts that are set up.
<code>save</code>	Save the settings in the non-volatile memory ( <i>nvm</i> ) in the “selected” configuration profile.

**Note:** When you are setting up a new user account in the Command Line Interface, remember to allocate the password.

### 3.4.6 Deactivating the user account

After a user account is deactivated, the device denies the related user access to the device management. In contrast to completely deleting it, deactivating a user account lets you keep the settings and reuse them in the future. To do this, perform the following steps:

- To keep the user account settings and reuse them in the future, you temporarily deactivate the user account.

- Open the *Device Security > User Management* dialog. The dialog displays the user accounts that are set up.
- In the row for the relevant user account, unmark the checkbox in the *Active* column.
- Save the changes temporarily. To do this, click the  button.

```
enable  
configure  
users disable <user>  
show users  
save
```

Change to the Privileged EXEC mode.  
Change to the Configuration mode.  
To disable user account.  
Displays the user accounts that are set up.  
Save the settings in the non-volatile memory (nvm) in the “selected” configuration profile.

- To permanently deactivate the user account settings, you delete the user account.

- Highlight the row for the relevant user account.
- Click the  button.

```
users delete <user>  
show users  
save
```

Deletes the user account <user>.  
Displays the user accounts that are set up.  
Save the settings in the non-volatile memory (nvm) in the “selected” configuration profile.

### 3.4.7 Adjusting policies for passwords

The device lets you check if the passwords for the user accounts adhere to the specified policy. When the passwords adhere to the policy, you obtain a higher level of complexity for the passwords.

The user management of the device lets you activate or deactivate the check separately in each user account. When you mark the checkbox and the new password fulfills the requirements of the policy, the device accepts the password change.

In the default settings, practical values for the policy are set up in the device. You have the option of adjusting the policy to meet your requirements. To do this, perform the following steps:

- Adjust the policy for passwords to meet your requirements.

- Open the *Device Security > User Management* dialog.

In the *Configuration* frame you specify the number user login attempts before the device locks out the user. You also specify the minimum number of characters that defines a password.

**Note:** The device lets only users with the *administrator* authorization remove the lock.

The number of login attempts as well as the possible lockout of the user apply only when accessing the device management through:

- ▶ the Graphical User Interface
- ▶ the SSH protocol
- ▶ the Telnet protocol

**Note:** When accessing the device management using the Command Line Interface through the serial connection, the number of login attempts is unlimited.

- Specify the values to meet your requirements.
  - ▶ In the *Login attempts* field you specify the number of times that a user attempts to log in. The field lets you define this value in the range 0..5. In the above example, the value 0 deactivates the function.
  - ▶ The *Min. password length* field lets you enter values in the range 1..64.

The dialog displays the policy set up in the *Password policy* frame.

- Adjust the values to meet your requirements.
  - ▶ Values in the range 1 through 16 are allowed. The value 0 deactivates the relevant policy.

To apply the entries specified in the *Configuration* and *Password policy* frames, mark the checkbox in the *Policy check* column for a particular user.

- Save the changes temporarily. To do this, click the  button.

enable	Change to the Privileged EXEC mode.
configure	Change to the Configuration mode.
passwords min-length 6	Specifies the policy for the minimum length of the password.
passwords min-lowercase-chars 1	Specifies the policy for the minimum number of lower-case letters in the password.
passwords min-numeric-chars 1	Specifies the policy for the minimum number of digits in the password.
passwords min-special-chars 1	Specifies the policy for the minimum number of special characters in the password.
passwords min-uppercase-chars 1	Specifies the policy for the minimum number of upper-case letters in the password.
show passwords	Displays the policies that are set up.
save	Save the settings in the non-volatile memory (NVM) in the “selected” configuration profile.

## 3.5 SNMP access

The SNMP protocol lets you work with a network management system to monitor the device over the network and change its settings.

### 3.5.1 SNMPv1/v2 access

Using SNMPv1 or SNMPv2 the network management system and the device communicate unencrypted. Every SNMP packet contains the community name in plain text and the IP address of the sender.

The community names `public` for read accesses and `private` for write accesses are preset in the device. If SNMPv1/v2 is enabled, then the device lets anyone who knows the community name have access to the device.

Make undesired access to the device more difficult. To do this, perform the following steps:

- Change the default community names in the device.  
Treat the community names with discretion.  
Anyone who knows the community name for write access, has the ability to change the settings of the device.
- Specify a different community name for read/write access than for read access.
- Use SNMPv1 or SNMPv2 only in environments protected from eavesdropping. The protocols do not use encryption.
- We recommend using SNMPv3 and disabling the access using SNMPv1 and SNMPv2 in the device.

### 3.5.2 SNMPv3 access

Using SNMPv3 the network management system and the device communicate encrypted. The network management system authenticates itself with the device using the login credentials of a user. The prerequisite for the SNMPv3 access is that in the network management system uses the same settings that are defined in the device.

The device lets you specify the *SNMP auth type* and *SNMP encryption type* parameters individually in each user account.

When you set up a new user account in the device, the parameters are preset so that the network management system Industrial HiVision reaches the device immediately.

The user accounts set up in the device use the same passwords in the Graphical User Interface, in the Command Line Interface, and for SNMPv3.

To adapt the SNMPv3 parameters of the user account settings to the settings in your network management system, perform the following steps:

- Open the *Device Security > User Management* dialog.  
The dialog displays the user accounts that are set up.

- Click the row of the relevant user account in the *SNMP auth type* field. Select the desired setting.
- Click the row of the relevant user account in the *SNMP encryption type* field. Select the desired setting.
- Save the changes temporarily. To do this, click the  button.

```
enable
configure
users snmpv3 authentication <user>
md5 | sha1

users snmpv3 encryption <user> des |
aes | aescfb128 | none

show users

save
```

Change to the Privileged EXEC mode.

Change to the Configuration mode.

Assigning the HMAC-MD5 or HMACSHA protocol for authentication requests to the user account *<user>*.

Assigns the DES or AES-128 algorithm to the user account *<user>*.

With this algorithm, the device encrypts authentication requests. The value *none* removes the encryption.

Display the user accounts that have been configured.

Save the settings in the non-volatile memory (*nvm*) in the “selected” configuration profile.

## 4 Managing configuration profiles

If you change the settings of the device during operation, then the device stores the changes in its memory (*RAM*). After a reboot the settings are lost.

In order to keep the changes after a reboot, the device lets you save the settings in a configuration profile in the non-volatile memory (*NVM*). In order to make it possible to quickly switch to other settings, the non-volatile memory offers storage space for multiple configuration profiles.



If an external memory is connected, then the device automatically saves a copy of the configuration profile in the external memory (*ENVM*). You can disable this function.

### 4.1 Detecting changed settings

The device stores changes made to settings during operation in its volatile memory (*RAM*). The configuration profile in the non-volatile memory (*NVM*) remains unchanged until you save the changed settings explicitly. Until then, the configuration profiles in memory and non-volatile memory are different. The device helps you recognize changed settings.

#### 4.1.1 Volatile memory (*RAM*) and non-volatile memory (*NVM*)

You can recognize when the configuration profile in the volatile memory (*RAM*) is different from the "selected" configuration profile in the non-volatile memory (*NVM*). To do this, perform the following steps:

- Check the status bar at the top of the menu:
  - When a blinking  icon is visible, the configuration profiles differ.
  - When no  icon is visible, the configuration profiles match.

Or:

- Open the *Basic Settings > Load/Save* dialog.
- Check the status of the checkbox in the *Information* frame:
  - When the checkbox is unmarked, the configuration profiles differ.
  - When the checkbox is marked, the configuration profiles match.

```
show config status
Configuration Storage sync State
-----
running-config to NV.....out of sync
...
```



### 4.1.2 External memory (ACA) and non-volatile memory (NVM)

You can also recognize when the copy in the external memory (ACA) is different from the configuration profile in the non-volatile memory (NVM). To do this, perform the following steps:

- Open the *Basic Settings > Load/Save* dialog.
- Check the status of the checkbox in the *Information* frame:
  - When the checkbox is unmarked, the configuration profiles differ.
  - When the checkbox is marked, the configuration profiles match.

```
show config status
Configuration Storage sync State
-----
...
NV to ACA.....out of sync
...
```

## 4.2 Saving the settings

### 4.2.1 Saving the configuration profile in the device

If you change the settings of the device during operation, then the device stores the changes in its memory (RAM). In order to keep the changes after a reboot, save the configuration profile in the non-volatile memory (NVM).

#### Saving a configuration profile

The device stores the settings in the "selected" configuration profile in the non-volatile memory (NVM).

Perform the following steps:

- Open the *Basic Settings > Load/Save* dialog.
- Verify that the required configuration profile is "Selected".  
You can recognize the "selected" configuration profile because the checkbox in the *Selected* column is marked.
- Click the  button.

```
show config profiles nvm
```

Displays the configuration profiles contained in the non-volatile memory (nvm).

```
enable
```

Change to the Privileged EXEC mode.

```
save
```

Save the settings in the non-volatile memory (nvm) in the "selected" configuration profile.

#### Copying settings to a configuration profile

The device lets you store the settings saved in the memory (RAM) in a configuration profile other than the "selected" configuration profile. In this way you create a new configuration profile in the non-volatile memory (NVM) or overwrite an existing one.

Perform the following steps:

- Open the *Basic Settings > Load/Save* dialog.
- Click the  button and then the *Save As..* item.  
The dialog displays the *Save As..* window.
- In the *Name* field, change the name of the configuration profile. If you keep the proposed name, the device will overwrite an existing configuration profile of the same name.
- Click the *Ok* button.

The new configuration profile is designated as "Selected".

```
show config profiles nvm  
  
enable  
  
copy config running-config nvm profile  
<string>
```

Displays the configuration profiles contained in the non-volatile memory (*nvm*).

Change to the Privileged EXEC mode.

Save the current settings in the configuration profile named *<string>* in the non-volatile memory (*nvm*). If present, the device overwrites a configuration profile of the same name. The new configuration profile is designated as “Selected”.

### Selecting a configuration profile

When the non-volatile memory (*NVM*) contains multiple configuration profiles, you have the option to select any configuration profile there. The device stores the settings in the “selected” configuration profile. Upon reboot, the device loads the settings of the “selected” configuration profile into the memory (*RAM*).

Perform the following steps:

- Open the *Basic Settings > Load/Save* dialog.

The table displays the configuration profiles present in the device. You can recognize the “selected” configuration profile because the checkbox in the *Selected* column is marked.

- In the table select the entry of the required configuration profile stored in the non-volatile memory (*NVM*).
- Click the  button and then the *Select* item.

In the *Selected* column, the checkbox of the configuration profile is now *marked*.

```
enable  
  
show config profiles nvm  
  
configure  
  
config profile select nvm 1  
  
save
```

Change to the Privileged EXEC mode.

Displays the configuration profiles contained in the non-volatile memory (*nvm*).

Change to the Configuration mode.

Identifier of the configuration profile.  
Take note of the adjacent name of the configuration profile.

Save the settings in the non-volatile memory (*nvm*) in the “selected” configuration profile.

## 4.2.2 Saving the configuration profile in the external memory

When an external memory is connected and you save a configuration profile, the device automatically saves a copy in the *Selected external memory*. In the default setting, the function is enabled. You can disable this function.

Perform the following steps:

- Open the *Basic Settings > External Memory* dialog.
- Mark the checkbox in the *Backup config when saving* column in order to enable the device to automatically save a copy in the external memory during the saving process.
- To deactivate the function, unmark the checkbox in the *Backup config when saving* column.
- Save the changes temporarily. To do this, click the  button.

```
enable
configure
config envm config-save sd
config envm config-save usb

no config envm config-save sd
no config envm config-save usb

save
```

Change to the Privileged EXEC mode.

Change to the Configuration mode.

Enable the function.

When you save a configuration profile, the device saves a copy in the external memory.

*sd* = External SD memory

*usb* = External USB memory

Disable the function.

The device does not save a copy in the external memory.

*sd* = External SD memory

*usb* = External USB memory

Save the settings in the non-volatile memory (*nvm*) in the “selected” configuration profile.

## 4.2.3 Backup the configuration profile on a remote server

The device lets you automatically backup the configuration profile to a remote server. The prerequisite is that you activate the function before you save the configuration profile.

After you save the configuration profile in the non-volatile memory (*nvm*), the device sends a copy to the specified URL.

Perform the following steps:

- Open the *Basic Settings > Load/Save* dialog.  
In the *Backup config on a remote server when saving* frame, perform the following steps:
- In the *URL* field, specify the server as well as the path and file name of the backed up configuration profile.
- Click the *Set credentials* button.  
The dialog displays the *Credentials* window.
- Enter the login credentials needed to authenticate on the remote server.
- In the *Operation* option list, enable the function.
- Save the changes temporarily. To do this, click the  button.

<code>enable</code>	Change to the Privileged EXEC mode.
<code>show config remote-backup</code>	Check status of the function.
<code>configure</code>	Change to the Configuration mode.
<code>config remote-backup destination</code>	Enter the destination URL for the configuration profile backup.
<code>config remote-backup username</code>	Enter the user name to authenticate on the remote server.
<code>config remote-backup password</code>	Enter the password to authenticate on the remote server.
<code>config remote-backup operation</code>	Enable the function.

If the transfer to the remote server is unsuccessful, then the device logs this event in the log file (System Log).

#### 4.2.4 Exporting a configuration profile

The device lets you save a configuration profile to a server as an XML file. If you use the Graphical User Interface, then you have the option to save the XML file directly to your PC.

Prerequisites:

- ▶ To save the file on a server, you need a configured server on the network.
- ▶ To save the file to an SCP or SFTP server, you also need the user name and password for accessing this server.

Perform the following steps:

- Open the [Basic Settings > Load/Save](#) dialog.
- In the table select the entry of the required configuration profile.

Export the configuration profile to your PC. To do this, perform the following steps:

- Click the link in the *Profile name* column.
  - Select the storage location and specify the file name.
  - Click the *Ok* button.
- The configuration profile is now saved as an XML file in the specified location.

Export the configuration profile to a remote server. To do this, perform the following steps:

- Click the  button and then the *Export...* item.  
The dialog displays the *Export...* window.
- In the *URL* field, specify the file URL on the remote server:
  - To save the file on an FTP server, specify the URL for the file in the following form:  
`ftp://<user>:<password>@<IP address>:<port>/<file name>`
  - To save the file on a TFTP server, specify the URL for the file in the following form:  
`tftp://<IP address>/<path>/<file name>`
  - To save the file on an SCP or SFTP server, specify the URL for the file in one of the following forms:  
`scp:// or sftp://<user>:<password>@<IP address>/<path>/<file name>`  
`scp:// or sftp://<IP address>/<path>/<file name>`  
When you click the *Ok* button, the device displays the *Credentials* window. There you enter *User name* and *Password* to log in to the server.
- Click the *Ok* button.  
The configuration profile is now saved as an XML file in the specified location.

```
show config profiles nvm
```

Displays the configuration profiles contained in the non-volatile memory (*nvm*).

```
enable
```

Change to the Privileged EXEC mode.

```
copy config running-config  
remote tftp://<IP_address>/ <path>/  
<file_name>
```

Save the current settings on a TFTP server.

```
copy config nvm remote sftp://  
<user_name>:<password>@<IP_address>/  
<path>/<file_name>
```

Save the selected configuration profile in the non-volatile memory (*nvm*) on a SFTP server.

```
copy config nvm profile config3  
remote tftp://<IP_address>/ <path>/  
<file_name>
```

Save the configuration profile *config3* in the non-volatile memory (*nvm*) on a TFTP server.

```
copy config nvm profile config3  
remote ftp://<IP_address>:<port>/  
<path>/<file_name>
```

Save the configuration profile *config3* in the non-volatile memory (*nvm*) on an FTP server.

## 4.3 Loading settings

If you save multiple configuration profiles in the memory, then you have the option to load a different configuration profile.

### 4.3.1 Activating a configuration profile

The non-volatile memory of the device can contain multiple configuration profiles. If you activate a configuration profile stored in the non-volatile memory (*NVM*), then you immediately change the settings in the device. The device does not require a reboot.

Perform the following steps:

- Open the *Basic Settings > Load/Save* dialog.
- In the table select the entry of the required configuration profile.
- Click the  button and then the *Activate* item.

The device copies the settings to the memory (*RAM*) and disconnects from the Graphical User Interface. The device immediately uses the settings of the configuration profile.

- Reload the Graphical User Interface.
- Log in again.

In the *Selected* column, the checkbox of the configuration profile that was activated before is marked.

```
show config profiles nvm

enable

copy config nvm profile config3
running-config
```

Displays the configuration profiles contained in the non-volatile memory (*nvm*).

Change to the Privileged EXEC mode.

Activate the settings of the configuration profile *config3* in the non-volatile memory (*nvm*). The device copies the settings into the volatile memory and disconnects the connection to the Command Line Interface. The device immediately uses the settings of the configuration profile *config3*.

### 4.3.2 Loading the configuration profile from the external memory

If an external memory is connected, then the device loads a configuration profile from the external memory upon restart automatically. The device lets you save these settings in a configuration profile in non-volatile memory.

When the external memory contains the configuration profile of an identical device, you have the possibility to transfer the settings from one device to another.

Perform the following steps:

- Verify that the device loads a configuration profile from the external memory upon restart. In the default setting, the function is enabled. If the function is disabled, enable it again as follows:

- Open the *Basic Settings > External Memory* dialog.
- In the *Config priority* column, select the value *first*.
- Save the changes temporarily. To do this, click the  button.

<pre>enable configure config envm load-priority sd first  config envm load-priority usb first  show config envm settings</pre>	<p>Change to the Privileged EXEC mode.</p> <p>Change to the Configuration mode.</p> <p>Enable the function. Upon reboot, the device loads a configuration profile from the external memory. <i>sd</i> = External SD memory</p> <p>Enable the function. Upon reboot, the device loads a configuration profile from the external memory. <i>usb</i> = External USB memory</p> <p>Displays the settings of the external memory (<i>envm</i>).</p>																				
<table border="1" style="width: 100%; border-collapse: collapse;"> <thead> <tr> <th style="text-align: left;">Type</th> <th style="text-align: left;">Status</th> <th style="text-align: left;">Auto Update</th> <th style="text-align: left;">Save Config</th> <th style="text-align: left;">Config Load Prio</th> </tr> </thead> <tbody> <tr> <td>sd</td> <td>ok</td> <td>[x]</td> <td>[x]</td> <td>second</td> </tr> <tr> <td>usb</td> <td>ok</td> <td>[x]</td> <td>[x]</td> <td>first</td> </tr> <tr> <td>save</td> <td></td> <td></td> <td></td> <td></td> </tr> </tbody> </table>	Type	Status	Auto Update	Save Config	Config Load Prio	sd	ok	[x]	[x]	second	usb	ok	[x]	[x]	first	save					<p>Save the settings in a configuration profile in the non-volatile memory (<i>NVM</i>) of the device.</p>
Type	Status	Auto Update	Save Config	Config Load Prio																	
sd	ok	[x]	[x]	second																	
usb	ok	[x]	[x]	first																	
save																					

Using the Command Line Interface, the device lets you copy the settings from the external memory directly into the non-volatile memory (*NVM*).

<pre>show config profiles nvm  enable copy config envm profile config3 nvm</pre>	<p>Displays the configuration profiles contained in the non-volatile memory (<i>nvm</i>).</p> <p>Change to the Privileged EXEC mode.</p> <p>Copy the configuration profile <i>config3</i> from the external memory (<i>envm</i>) to the non-volatile memory (<i>nvm</i>).</p>
--	---

The device can also automatically load a configuration profile from a script file during the boot process.

Prerequisites:

- ▶ Verify that the external memory is connected before you start the device.
- ▶ The root directory of the external memory contains a text file *startup.txt* with the content *script=<file\_name>*. The placeholder *<file\_name>* represents the script file that the device executes during the boot process.
- ▶ The root directory of the external memory contains the script file. You have the option to save the script with a user-specified name. Save the file with the file extension *.cli*.



**Note:** Verify that the script saved in the external memory is not empty. If the script is empty, then the device loads the next configuration profile as per the configuration priority settings.

After applying the script, the device automatically saves the configuration profile from the script file as an XML file in the external memory. When you type the appropriate command into the script file, you have the option to disable this function:

- `no config envm config-save sd`  
The device does not create a copy in the external SD memory.
- `no config envm config-save usb`  
The device does not create a copy in the external USB memory.

When the script file contains an incorrect command, the device does not apply this command during the boot process. The device logs the event in the log file (System Log).

### 4.3.3 Importing a configuration profile

The device lets you import from a server a configuration profile saved as an XML file. If you use the Graphical User Interface, then you can import the XML file directly from your PC.

Prerequisites:

- ▶ To save the file on a server, you need a configured server on the network.
- ▶ To save the file to an SCP or SFTP server, you also need the user name and password for accessing this server.

Perform the following steps:

- Open the *Basic Settings > Load/Save* dialog.
- Click the  button and then the *Import...* item. The dialog displays the *Import...* window.
- In the *Select source* drop-down list, select the location from where the device imports the configuration profile.
  - *PC/URL*  
The device imports the configuration profile from the local PC or from a remote server.
  - *External memory*  
The device imports the configuration profile from the selected external memory.

Import the configuration profile from the local PC or from a remote server. To do this, perform the following steps:

- Import the configuration profile:
  - When the file is located on an FTP server, specify the URL for the file in the following form:  
`ftp://<user>:<password>@<IP address>:<port>/<file name>`
  - When the file is located on a TFTP server, specify the URL for the file in the following form:  
`tftp://<IP address>/<path>/<file name>`
  - When the file is located on an SCP or SFTP server, specify the URL for the file in one of the following forms:  
`scp://` or `sftp://<IP address>/<path>/<file name>`  
When you click the **Start** button, the device displays the **Credentials** window. There you enter **User name** and **Password** to log in to the server.  
`scp://` or `sftp://<user>:<password>@<IP address>/<path>/<file name>`
- In the **Destination** frame, specify where the device saves the imported configuration profile:
  - In the **Profile name** field, specify the name under which the device saves the configuration profile.
  - In the **Storage type** field, specify the storage location for the configuration profile.
- Click the **Ok** button.

The device copies the configuration profile into the specified memory.

If you specified the value `ram` in the **Destination** frame, then the device disconnects the Graphical User Interface and uses the settings immediately.

Import the configuration profile from the external memory. To do this, perform the following steps:

- In the **Import profile from external memory** frame, **Profile name** drop-down list, select the name of the configuration profile to be imported.  
The prerequisite is that the external memory contains an exported configuration profile.
- In the **Destination** frame, specify where the device saves the imported configuration profile:
  - In the **Profile name** field, specify the name under which the device saves the configuration profile.
- Click the **Ok** button.

The device copies the configuration profile into the non-volatile memory (**NVM**) of the device.

If you specified the value `ram` in the **Destination** frame, then the device disconnects the Graphical User Interface and uses the settings immediately.

```
enable

copy config remote ftp://
<IP_address>:<port>/<path>/<file_name>
running-config

copy config remote tftp://
<IP_address>/ <path>/<file_name>
running-config

copy config remote sftp://
<user name>:<password>@<IP_address>/
<path>/<file_name> running-config

copy config remote ftp://
<IP_address>:<port>/<path>/<file_name>
nvm profile config3

copy config remote tftp://
<IP_address>/<path>/<file_name>
nvm profile config3
```

Change to the Privileged EXEC mode.

Import and activate the settings of a configuration profile saved on an FTP server.

The device copies the settings into the volatile memory and disconnects the connection to the Command Line Interface. The device immediately uses the settings of the imported configuration profile.

Import and activate the settings of a configuration profile saved on a TFTP server.

The device copies the settings into the volatile memory and disconnects the connection to the Command Line Interface. The device immediately uses the settings of the imported configuration profile.

Import and activate the settings of a configuration profile saved on a SFTP server.

The device copies the settings into the volatile memory and disconnects the connection to the Command Line Interface. The device immediately uses the settings of the imported configuration profile.

Import the settings of a configuration profile saved on an FTP server and save the settings in the configuration profile `config3` in the non-volatile memory (nvm).

Import the settings of a configuration profile saved on a TFTP server and save the settings in the configuration profile `config3` in the non-volatile memory (nvm).

## 4.4 Reset the device to the factory defaults

If you reset the settings in the device to the delivery state, then the device deletes the configuration profiles in the volatile memory and in the non-volatile memory.

If an external memory is connected, then the device also deletes the configuration profiles saved in the external memory.

The device then reboots and loads the factory settings.

### 4.4.1 Using the Graphical User Interface or Command Line Interface

Perform the following steps:

- Open the *Basic Settings > Load/Save* dialog.
- Click the  button, then *Back to factory....*  
The dialog displays a message.
- Click the *Ok* button.

The device deletes the configuration profiles in the memory (*RAM*) and in the non-volatile memory (*NVM*).

If an external memory is connected, then the device also deletes the configuration profiles saved in the external memory.

After a brief period, the device restarts and loads the delivery settings.

```
enable
clear factory
```

Change to the Privileged EXEC mode.

Deletes the configuration profiles from the non-volatile memory and from the external memory. If an external memory is connected, then the device also deletes the configuration profiles saved in the external memory.

After a brief period, the device restarts and loads the delivery settings.

### 4.4.2 Using the System Monitor

Prerequisite:

- Your PC is connected with the serial connection of the device using a terminal cable.

Perform the following steps:

- Restart the device.
- To change to the System Monitor, press the <1> key within 3 seconds when prompted during reboot.  
The device loads the System Monitor.
- To change from the main menu to the *Manage configurations* menu, press the <4> key.
- To execute the *Clear configs and boot params* command, press the <1> key.

- To load the factory settings, press the <Enter> key.  
The device deletes the configuration profiles in the memory ([RAM](#)) and in the non-volatile memory ([NVM](#)).  
If an external memory is connected, then the device also deletes the configuration profiles saved in the external memory.
- To change to the main menu, press the <q> key.
- To reboot the device with factory settings, press the <q> key.

## 5 Loading software updates

Hirschmann is continually working on improving and developing their software. Check regularly if there is an updated version of the software that provides you with additional benefits. You find information and software downloads on the Hirschmann product pages on the Internet at [www.hirschmann.com](http://www.hirschmann.com).

The device gives you the following options for updating the device software:

- ▶ [Software update from the PC](#)
- ▶ [Software update from a server](#)
- ▶ [Software update from the external memory](#)
- ▶ [Loading a previous software version](#)

**Note:** The device settings are kept after updating the device software.

You see the version of the installed device software in the login dialog of the Graphical User Interface.

To display the version of the installed software when you are already logged in, perform the following steps:

- Open the [Basic Settings > Software](#) dialog.  
The [Running version](#) field displays the version number and creation date of the device software that the device loaded during the last restart and is currently running.

enable

show system info

Change to the Privileged EXEC mode.

Displays the system information such as the version number and creation date of the device software that the device loaded during the last restart and is currently running.

### 5.1 Software update from the PC

The prerequisite is that the image file of the device software is saved on a data carrier which is accessible from your PC.

Perform the following steps:

- Navigate to the folder where the image file of the device software is saved.
- Open the [Basic Settings > Software](#) dialog.
- Drag and drop the image file in the  area. Alternatively click in the area to select the file.
- To start the update procedure, click the [Start](#) button.  
As soon as the update procedure is completed successfully, the device displays an information that the software is successfully updated.  
Upon restart, the device loads the installed device software.

## 5.2 Software update from a server

To update the software using SFTP or SCP you need a server on which the image file of the device software is saved.

To update the software using TFTP, SFTP or SCP you need a server on which the image file of the device software is saved.

Perform the following steps:

- Open the *Basic Settings > Software* dialog.
- In the *Software update* frame, *URL* field, enter the URL for the image file in the following form:
  - ▶ When the image file is saved on an FTP server:  
`ftp://<IP_address>:<port>/<path>/<image_file_name>.bin`
  - ▶ When the image file is saved on a TFTP server:  
`tftp://<IP_address>/<path>/<image_file_name>.bin`
  - ▶ When the image file is saved on a SCP or SFTP server:  
`scp:// or sftp://<IP_address>/<path>/<image_file_name>.bin`  
`scp:// or sftp://<username>:<password>@<IP_address>/<path>/<image_file_name>.bin`  
When you enter the URL without the user name and password, the device displays the *Credentials* window. There you enter the login credentials needed to log in to the server.
- To start the update procedure, click the *Start* button.  
The device copies the currently running device software into the backup memory.  
As soon as the update procedure is completed successfully, the device displays an information that the software is successfully updated.  
Upon restart, the device loads the installed device software.

```
enable
```

```
copy firmware remote tftp://10.0.1.159/  
product.bin system
```

Change to the Privileged EXEC mode.

Transfer the `product.bin` file from the TFTP server with the IP address `10.0.1.159` to the device.

## 5.3 Software update from the external memory

### 5.3.1 Manually—initiated by the administrator

The device lets you update the device software with a few mouse clicks. The prerequisite is that the image file of the device software is located in the external memory.

Perform the following steps:

- Open the [Basic Settings > Software](#) dialog.
- In the table mark the row which displays the name of the desired image file in the external memory.
- Right-click to display the context menu.
- To start the update procedure, click in the context menu the [Update](#) item.  
The device copies the currently running device software into the backup memory.  
As soon as the update procedure is completed successfully, the device displays an information that the software is successfully updated.  
Upon restart, the device loads the installed device software.

### 5.3.2 Automatically—initiated by the device

When the following files are located in the external memory during a restart, the device updates the device software automatically:

- ▶ the image file of the device software
- ▶ a text file `startup.txt` with the content `autoUpdate=<Image_file_name>.bin`

The prerequisite is that in the [Basic Settings > External Memory](#) dialog, you mark the checkbox in the [Software auto update](#) column. This is the default setting in the device.

Perform the following steps:

- Copy the image file of the new device software into the main directory of the external memory. Use only an image file suitable for the device.
- Create a text file `startup.txt` in the main directory of the external memory.
- Open the `startup.txt` file in the text editor and add the following line:  
`autoUpdate=<Image_file_name>.bin`
- Install the external memory in the device.
- Restart the device.

During the booting process, the device checks automatically the following criteria:

- Is an external memory connected?
- Is a `startup.txt` file in the main directory of the external memory?
- Does the image file exist which is specified in the `startup.txt` file?
- Is the software version of the image file more recent than the software currently running in the device?

When the criteria are fulfilled, the device starts the update procedure.

The device copies the currently running device software into the backup memory.

As soon as the update procedure is completed successfully, the device reboots automatically and loads the new software version.

- Check the result of the update procedure. The log file in the [Diagnostics > Report > System Log](#) dialog contains one of the following messages:
  - `S_watson_AUTOMATIC_SWUPDATE_SUCCESS`  
Software update completed successfully



- `S_watson_AUTOMATIC_SWUPDATE_ABORTED`  
Software update aborted
- `S_watson_AUTOMATIC_SWUPDATE_ABORTED_WRONG_FILE`  
Software update aborted due to wrong image file
- `S_watson_AUTOMATIC_SWUPDATE_ABORTED_SAVING_FILE`  
Software update aborted because the device did not save the image file.

## 5.4 Loading a previous software version

The device lets you replace the device software with a previous version. The basic settings in the device are kept after replacing the device software.

**Note:** Only the settings for functions which are available in the newer device software version are lost.



## 6 Configuring the ports

The following port configuration functions are available.

- ▶ Enabling/disabling the port
- ▶ Selecting the operating mode

### 6.1 Enabling/disabling the port

In the default setting, every port is enabled. For a higher level of access security, disable unconnected ports. To do this, perform the following steps:

- Open the *Basic Settings > Port* dialog, *Configuration* tab.
- To enable a port, mark the checkbox in the *Port on* column.
- To disable a port, unmark the checkbox in the *Port on* column.
- Save the changes temporarily. To do this, click the  button.

enable

configure

interface 1/1

no shutdown

Change to the Privileged EXEC mode.

Change to the Configuration mode.

Change to the interface configuration mode of interface 1/1.

Enable the interface.

## 6.2 Selecting the operating mode

In the default setting, the ports are set to *Automatic configuration* operating mode.

**Note:** The active automatic configuration has priority over the manual configuration.

Perform the following steps:

- Open the *Basic Settings > Port* dialog, *Configuration* tab.
- If the device connected to this port requires a fixed setting, then perform the following steps:
  - Deactivate the function. Unmark the checkbox in the *Automatic configuration* column.
  - In the *Manual configuration* column, enter the desired operating mode (transmission rate, duplex mode).
- Save the changes temporarily. To do this, click the  button.

```
enable
```

```
configure
```

```
interface 1/1
```

```
no auto-negotiate
```

```
speed 100 full
```

Change to the Privileged EXEC mode.

Change to the Configuration mode.

Change to the interface configuration mode of interface *1/1*.

Disable the automatic configuration mode.

Port speed 100 MBit/s, full duplex

## 7 Assistance in the protection from unauthorized access

The device offers functions that help you protect the device against unauthorized access.

After you set up the device, carry out the following steps in order to reduce possible unauthorized access to the device.

- ▶ Changing the SNMPv1/v2 community
- ▶ Disabling SNMPv1/v2
- ▶ Disabling HTTP
- ▶ Using your own HTTPS certificate
- ▶ Using your own SSH key
- ▶ Disabling Telnet
- ▶ Disabling HiDiscovery
- ▶ Enable IP access restriction
- ▶ Adjusting the session timeouts
- ▶ Deactivating the unused modules

### 7.1 Changing the SNMPv1/v2 community

SNMPv1/v2 works unencrypted. Every SNMP packet contains the IP address of the sender and the plaintext community name with which the sender accesses the device. If SNMPv1/v2 is enabled, then the device lets anyone who knows the community name access the device.

The community names `public` for read accesses and `private` for write accesses are preset. If you are using SNMPv1 or SNMPv2, then change the default community name. Treat the community names with discretion. To do this, perform the following steps:

- Open the *Device Security > Management Access > SNMPv1/v2 Community* dialog.

The dialog displays the communities that are set up.

- For the *Write* community, specify in the *Name* column the community name.
  - ▶ Up to 32 alphanumeric characters are allowed.
  - ▶ The device differentiates between upper and lower case.
  - ▶ Specify a different community name than for read access.
- Save the changes temporarily. To do this, click the  button.

```
enable
configure
snmp community rw <community name>
show snmp community

save
```

Change to the Privileged EXEC mode.

Change to the Configuration mode.

Specify the community for read/write access.

Display the communities that have been configured.

Save the settings in the non-volatile memory (*nvm*) in the “selected” configuration profile.

## 7.2 Disabling SNMPv1/v2

If you need SNMPv1 or SNMPv2, then use these protocols only in environments protected from eavesdropping. SNMPv1 and SNMPv2 do not use encryption. The SNMP packets contain the community in clear text. We recommend using SNMPv3 in the device and disabling the access using SNMPv1 and SNMPv2. To do this, perform the following steps:

- Open the *Device Security > Management Access > Server* dialog, *SNMP* tab. The dialog displays the settings of the SNMP server.
- To deactivate the SNMPv1 protocol, you unmark the *SNMPv1* checkbox.
- To deactivate the SNMPv2 protocol, you unmark the *SNMPv2* checkbox.
- Save the changes temporarily. To do this, click the  button.

```
enable
configure
no snmp access version v1
no snmp access version v2
show snmp access
save
```

Change to the Privileged EXEC mode.  
Change to the Configuration mode.  
Deactivate the SNMPv1 protocol.  
Deactivate the SNMPv2 protocol.  
Display the SNMP server settings.  
Save the settings in the non-volatile memory (*nvm*) in the “selected” configuration profile.

## 7.3 Disabling HTTP

The web server provides the Graphical User Interface with the protocol HTTP or HTTPS. HTTPS connections are encrypted, while HTTP connections are unencrypted.

The HTTP protocol is enabled by default. If you disable HTTP, then no unencrypted access to the Graphical User Interface is possible. To do this, perform the following steps:

- Open the *Device Security > Management Access > Server* dialog, *HTTP* tab.
- To disable the HTTP protocol, select the *Off* radio button in the *Operation* frame.
- Save the changes temporarily. To do this, click the  button.

<code>enable</code>	Change to the Privileged EXEC mode.
<code>configure</code>	Change to the Configuration mode.
<code>no http server</code>	Disable the HTTP protocol.

If the HTTP protocol is disabled, then you can reach the Graphical User Interface of the device only by HTTPS. In the address bar of the web browser, enter the string `https://` before the IP address of the device.

If the HTTPS protocol is disabled and you also disable HTTP, then the Graphical User Interface is unaccessible. To work with the Graphical User Interface, enable the HTTPS server using the Command Line Interface. To do this, perform the following steps:

<code>enable</code>	Change to the Privileged EXEC mode.
<code>configure</code>	Change to the Configuration mode.
<code>https server</code>	Enable the HTTPS protocol.



## 7.4 Disabling Telnet

The device lets you remotely access the device management using Telnet or SSH. Telnet connections are unencrypted, while SSH connections are encrypted.

The Telnet server is enabled in the device by default. If you disable Telnet, then unencrypted remote access to the Command Line Interface is no longer possible. To do this, perform the following steps:

- Open the *Device Security > Management Access > Server* dialog, *Telnet* tab.
- To disable the Telnet server, select the *Off* radio button in the *Operation* frame.
- Save the changes temporarily. To do this, click the  button.

enable

Change to the Privileged EXEC mode.

configure

Change to the Configuration mode.

no telnet server

Disable the Telnet server.

If the SSH server is disabled and you also disable Telnet, then access to the Command Line Interface is only possible through the serial interface of the device. To work remotely with the Command Line Interface, enable SSH. To do this, perform the following steps:

- Open the *Device Security > Management Access > Server* dialog, *SSH* tab.
- To enable the *SSH* server, select the *On* radio button in the *Operation* frame.
- Save the changes temporarily. To do this, click the  button.

enable

Change to the Privileged EXEC mode.

configure

Change to the Configuration mode.

ssh server

Enable the SSH server.

## 7.5 Disabling the HiDiscovery access

HiDiscovery lets you assign IP parameters to the device over the network during commissioning. HiDiscovery communicates in the device management VLAN without encryption and authentication.

After the device is commissioned, we recommend to setHiDiscoveryto read-only or to disable HiDiscovery access completely. To do this, perform the following steps:

- Open the *Basic Settings > Network* dialog.
- To take away write permission from the HiDiscovery software, in the *HiDiscovery protocol v1/v2* frame, specify the value `readOnly` in the *Access* field.
- To disable HiDiscovery access completely, select the *Off* radio button in the *HiDiscovery protocol v1/v2* frame.
- Save the changes temporarily. To do this, click the  button.

`enable`

`network hidiscovery mode read-only`

`no network hidiscovery operation`

Change to the Privileged EXEC mode.

Disable write permission of the HiDiscovery software.

Disable HiDiscovery access.

## 7.6 Activating the IP access restriction

In the default setting, you access the device management from any IP address and with the supported protocols.

The IP access restriction lets you restrict access to the device management to selected IP address ranges and selected IP-based protocols.



Example:

The device is to be accessible only from the company network using the Graphical User Interface. The administrator has additional remote access using SSH. The company network has the address range `192.168.1.0/24` and remote access from a mobile network with the IP address range `109.237.176.0/24`. The SSH application program knows the fingerprint of the RSA key.

Table 13: Parameters for the IP access restriction

Parameter	Company network	Mobile phone network
Network address	192.168.1.0	109.237.176.0
Netmask	24	24
Desired protocols	https, snmp	ssh

Perform the following steps:

- Open the *Device Security > Management Access > IP Access Restriction* dialog.
  - Unmark the checkbox in the *Active* column for the entry.  
This entry lets users have access to the device from any IP address and the supported protocols.
- Address range of the company network:
- To add a table entry, click the  button.
  - Specify the address range of the company network in the *IP address range* column:  
`192.168.1.0/24`
  - For the address range of the corporate network, deactivate the undesired protocols. The *HTTPS*, *SNMP*, and *Active* checkboxes remain marked.
- Address range of the mobile phone network:
- To add a table entry, click the  button.
  - Specify the address range of the mobile network in the *IP address range* column:  
`109.237.176.0/24`
  - For the address range of the mobile network, deactivate the undesired protocols. The *SSH* and *Active* checkboxes remain marked.
- Before you enable the function, verify that at least one active entry in the table lets you have access. Otherwise, if you change the settings, then the connection to the device terminates. Access to the device management is only possible using the Command Line Interface through the serial interface of the device.
- To enable IP access restriction, select the *On* radio button in the *Operation* frame.
  - Save the changes temporarily. To do this, click the  button.

<code>enable</code>	Change to the Privileged EXEC mode.
<code>show network management access global</code>	Displays if IP access restriction is enabled or disabled.
<code>show network management access rules</code>	Display the entries that have been configured.
<code>no network management access operation</code>	Disable the IP access restriction.
<code>network management access add 2</code>	Create the entry for the address range of the company network. Number of the next available index in this example: 2.
<code>network management access modify 2 ip 192.168.1.0</code>	Specify the IP address of the company network.
<code>network management access modify 2 mask 24</code>	Specify the netmask of the company network.
<code>network management access modify 2 ssh disable</code>	Deactivate SSH for the address range of the company network. Repeat the operation for every unwanted protocol.
<code>network management access add 3</code>	Create an entry for the address range of the mobile phone network. Number of the next available index in this example: 3.
<code>network management access modify 3 ip 109.237.176.0</code>	Specify the IP address of the mobile phone network.
<code>network management access modify 3 mask 24</code>	Specify the netmask of the mobile phone network.
<code>network management access modify 3 snmp disable</code>	Deactivate SNMP for the address range of the mobile phone network. Repeat the operation for every unwanted protocol.
<code>no network management access status 1</code>	Deactivate the default entry. This entry lets users have access to the device from any IP address and the supported protocols.
<code>network management access status 2</code>	Activate an entry for the address range of the company network.
<code>network management access status 3</code>	Activate an entry for the address range of the mobile phone network.
<code>show network management access rules</code>	Display the entries that have been configured.
<code>network management access operation</code>	Enable the IP access restriction.

## 7.7 Adjusting the session timeouts

The device lets you automatically terminate the session upon inactivity of the logged-on user. The session timeout is the period of inactivity after the last user action.

You can specify a session timeout for the following applications:

- ▶ Command Line Interface sessions using an SSH connection
- ▶ Command Line Interface sessions using a Telnet connection
- ▶ Command Line Interface sessions using a serial connection
- ▶ Graphical User Interface

### Timeout for Command Line Interface sessions using a SSH connection

Perform the following steps:

- Open the [Device Security > Management Access > Server](#) dialog, [SSH](#) tab.
- Specify the timeout period in minutes in the [Configuration](#) frame, [Session timeout \[min\]](#) field.
- Save the changes temporarily. To do this, click the  button.

```
enable
configure
ssh timeout <0..160>
```

Change to the Privileged EXEC mode.

Change to the Configuration mode.

Specify the timeout period in minutes for Command Line Interface sessions using an SSH connection.

### Timeout for Command Line Interface sessions using a Telnet connection

Perform the following steps:

- Open the [Device Security > Management Access > Server](#) dialog, [Telnet](#) tab.
- Specify the timeout period in minutes in the [Configuration](#) frame, [Session timeout \[min\]](#) field.
- Save the changes temporarily. To do this, click the  button.

```
enable
configure
telnet timeout <0..160>
```

Change to the Privileged EXEC mode.

Change to the Configuration mode.

Specify the timeout period in minutes for Command Line Interface sessions using a Telnet connection.

### Timeout for Command Line Interface sessions using a serial connection

Perform the following steps:

- Open the *Device Security > Management Access > CLI* dialog, *Global* tab.
- Specify the timeout period in minutes in the *Configuration* frame, *Serial interface timeout [min]* field.
- Save the changes temporarily. To do this, click the  button.

```
enable  
cli serial-timeout <0..160>
```

Change to the Privileged EXEC mode.

Specify the timeout period in minutes for Command Line Interface sessions using a serial connection.

### Session timeout for the Graphical User Interface

Perform the following steps:

- Open the *Device Security > Management Access > Web* dialog.
- Specify the timeout period in minutes in the *Configuration* frame, *Web interface session timeout [min]* field.
- Save the changes temporarily. To do this, click the  button.

```
enable  
network management access web timeout  
<0..160>
```

Change to the Privileged EXEC mode.

Specify the timeout period in minutes for Graphical User Interface sessions

## 7.8 Deactivating the unused modules

The default settings of a media module slot allow access to the network. If a media module is inserted into an empty slot, the media module's ports will establish network connections by default.

To help prevent unauthorized network access, deactivate the unused slots. To do this, perform the following steps:

- Open the *Basic Settings > Modules* dialog.
- To deactivate the slot and deny network access, unmark the *Active* checkbox.
- Save the changes temporarily. To do this, click the  button.

## 8 Controlling the data traffic

The device checks the data packets to be forwarded in accordance with defined rules. Data packets to which the rules apply are either forwarded by the device or blocked. If data packets do not correspond to any of the rules, then the device blocks the packets.

Routing ports to which no rules are assigned allow packets to pass. As soon as a rule is assigned, the assigned rules are processed first. After that, the specified standard action of the device takes effect.

The device provides the following functions for controlling the data stream:

- ▶ Service request control (Denial of Service, DoS)
- ▶ Denying access to devices based on their IP or MAC address (Access Control List)

The device observes and monitors the data stream. The device takes the results of the observation and the monitoring and combines them with the rules for the network security to create what is known as a status table. Based on this status table, the device decides whether to accept, drop or reject data.

The data packets go through the filter functions of the device in the following sequence:

- ▶ DoS ... if `permit` or `accept`, then progress to the next rule
- ▶ ACL ... if `permit` or `accept`, then progress to the next rule

### 8.1 Helping protect against unauthorized access

With this function, the device supports you in helping protect against invalid or falsified data packets targeted at causing the failure of certain services or devices. You have the option of specifying filters in order to restrict data stream for protection against denial-of-service attacks. The activated filters check incoming data packets and discard them as soon as a match with the filter criteria is found.

The *Network Security > DoS > Global* dialog contains 2 frames in which you activate different filters. To activate them, mark the corresponding checkboxes.

In the *TCP/UDP* frame, you activate up to 4 filters that only influence TCP and UDP packets. Using this filter, you deactivate port scans, which attackers use to try to recognize devices and services offered. The filters operate as follows:

Table 14: DoS filters for TCP packets

Filter	Action
Activate Null Scan Filter	The device detects and discards TCP packets for which no TCP flags are set.
Activate Xmas Filter	The device detects and discards TCP packets for which the TCP flags FIN, URG and PUSH are simultaneously set.
Activate SYN/FIN Filter	The device detects and discards TCP packets for which the TCP flags SYN and FIN are simultaneously set.
Activate Minimal Header Filter	The device detects and discards TCP packets for which the TCP header is too short.



The *ICMP* frame offers you 2 filter options for ICMP packets. Fragmentation of incoming ICMP packets is a sign of an attack. If you activate this filter, then the device detects fragmented ICMP packets and discards them. Using the *Allowed payload size [byte]* parameter, you can also specify the maximum permissible size of the payload of the ICMP packets. The device discards data packets that exceed this byte specification.

**Note:** You can combine the filters in any way in the *Network Security > DoS > Global* dialog. When several filters are selected, a logical Or applies: If the first or second (or the third, etc.) filter applies to a data packet, then the device discards it.

## 8.2 ACL

In this menu you can enter the parameters for the Access Control Lists (ACLs).

The device uses ACLs to filter data packets received on VLANs or on individual or multiple ports. In a ACL, you specify rules that the device uses to filter data packets. When such a rule applies to a packet, the device applies the actions specified in the rule to the packet. The available actions are as follows:

- ▶ allow ([permit](#))
- ▶ discard ([deny](#))
- ▶ redirect to a certain port (see [Redirection port](#) field)
- ▶ mirror (see [Mirror port](#) field)

The list below contains criteria that you can apply to filter the data packets:

- ▶ Source or destination address of a packet (MAC)
- ▶ Source or destination address of a data packet (IPv4)
- ▶ Source or destination port of a data packet (IPv4)

You can specify the following ACL types:

- ▶ IP ACLs for VLANs
- ▶ IP ACLs for ports
- ▶ MAC ACLs for VLANs
- ▶ MAC ACLs for ports

When you assign both an IP ACL and MAC ACL to the same interface, the device first uses the IP ACL to filter the data stream. The device applies the MAC ACL rules only after the packets are filtered through the IP ACL. The priority of an ACL is independent of the index of a rule.

Within an ACL, the device processes the rules in order. The index of the respective rule determines the order in which the device filters the data stream. When you assign an ACL to a port or VLAN, you can specify its priority with the index. The lower the number, the higher the priority. The device processes the rule with the higher priority first.

If none of the rules specified in an ACL applies to a data packet, then the implicit [deny](#) rule applies. As a result, the device drops the received data packets.

Keep in mind that the device directly implements the implicit [deny](#) rule.

**Note:** The number of available ACLs depends on the device. You find more information about the ACL values in the chapter [“Technical Data” on page 332](#).

**Note:** You can assign a single ACL to any number of ports or VLANs.

The [ACL](#) menu contains the following dialogs:

- ▶ [ACL IPv4 Rule](#)
- ▶ [ACL MAC Rule](#)
- ▶ [ACL Assignment](#)

These dialogs provide the following options:



- ▶ To specify the rules for the various ACL types.
- ▶ To provide the rules with the required priorities.
- ▶ To assign the ACLs to ports or VLANs.

### 8.2.1 Creating and editing IPv4 rules

When filtering IPv4 data packets, the device lets you:

- ▶ create new groups and rules
- ▶ add new rules to existing groups
- ▶ edit an existing rule
- ▶ activate and deactivate groups and rules
- ▶ delete existing groups and rules
- ▶ change the order of existing rules

Perform the following steps:

- Open the *Network Security > ACL > IPv4 Rule* dialog.
- Click the  button.  
The dialog displays the *Create* window.
- To create a group, specify a meaningful name in the *Group name* field. You can combine several rules in one group.
- To add a rule to an existing group, select the name of the group in the *Group name* field.
- In the *Index* field you specify the number for the rule within the ACL.  
This number defines the priority of the rule.
- Click the *Ok* button.  
The device adds the rule to the table.  
Group and role are active immediately.  
To deactivate group or rules, unmark the checkbox in the *Active* column.  
To remove a rule, highlight the affected table entry and click the  button.
- Edit the rule parameters in the table.  
To change a value, double-click the relevant field.
- Save the changes temporarily. To do this, click the  button.

**Note:** The device lets you use wildcards with the *Source IP address* and *Destination IP address* parameters. If you enter for example, `192.168.?.?`, then the device allows addresses that start with `192.168`.

**Note:** The prerequisite for changing the values in the *Source TCP/UDP port* and *Destination TCP/UDP port* column is that you specify the value `tcp` or `udp` in the *Protocol* column.

**Note:** The prerequisite for changing the value in the *Redirection port* and *Mirror port* column is that you specify the value `permit` in the *Action* column.

## 8.2.2 Creating and configuring an IP ACL using the Command Line Interface

In the following example, you configure ACLs to block communications from computers B and C, to computer A via IP (TCP, UDP, etc.).

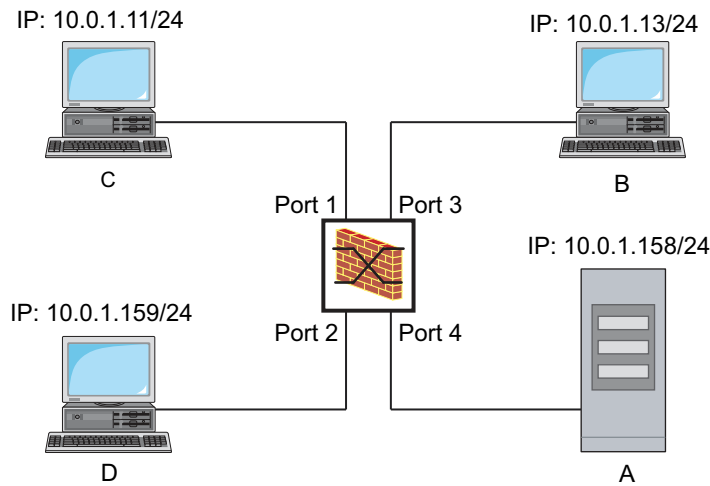

Figure 18: Example of an IP ACL

Perform the following steps:

<code>enable</code>	Change to the Privileged EXEC mode.
<code>configure</code>	Change to the Configuration mode.
<code>ip acl add 1 filter</code>	Adds an IP ACL with the ID <code>1</code> and the name <code>filter</code> .
<code>ip acl rule add 1 1 deny src 10.0.1.11 0.0.0.0 dst 10.0.1.158 0.0.0.0</code>	Adds a rule to position <code>1</code> of the IP ACL with the ID <code>1</code> denying IP data packets from <code>10.0.1.11</code> to <code>10.0.1.158</code> .
<code>ip acl rule add 1 2 permit src any any dst any any</code>	Adds a rule to position <code>2</code> of the IP ACL with the ID <code>1</code> admitting IP data packets.
<code>show acl ip rules 1</code>	Displays the rules of the IP ACL with the ID <code>1</code> .
<code>ip acl add 2 filter2</code>	Adds an IP ACL with the ID <code>2</code> and the name <code>filter2</code> .
<code>ip acl rule add 2 1 deny src 10.0.1.13 0.0.0.0 dst 10.0.1.158 0.0.0.0</code>	Adds a rule to position <code>1</code> of the IP ACL with the ID <code>2</code> denying IP data packets from <code>10.0.1.13</code> to <code>10.0.1.158</code> .
<code>ip acl rule add 2 2 permit src any any dst any any</code>	Adds a rule to position <code>2</code> of the IP ACL with the ID <code>2</code> admitting IP data packets.
<code>show acl ip rules 2</code>	Displays the rules of the IP ACL with the ID <code>2</code> .
<code>interface 1/1</code>	Change to the interface configuration mode of interface <code>1/1</code> .
<code>acl ip assign 1 in 1</code>	Assigns the IP ACL with the ID <code>1</code> to incoming data packets ( <code>in</code> ) on interface <code>1/1</code> , with a priority of <code>1</code> (highest priority).
<code>exit</code>	Leaves the interface mode.
<code>interface 1/3</code>	Change to the interface configuration mode of interface <code>1/3</code> .
<code>acl ip assign 2 in 1</code>	Assigns the IP ACL with the ID <code>2</code> to incoming data packets ( <code>in</code> ) on interface <code>1/3</code> , with a priority of <code>1</code> (highest priority).



<code>exit</code>	Leaves the interface mode.
<code>show acl ip assignment 1</code>	Displays the assignment of the IP ACL with ID 1.
<code>show acl ip assignment 2</code>	Displays the assignment of the IP ACL with ID 2.

### 8.2.3 Creating and editing MAC rules

When filtering MAC data packets, the device lets you:

- ▶ create new groups and rules
- ▶ add new rules to existing groups
- ▶ edit an existing rule
- ▶ activate and deactivate groups and rules
- ▶ delete existing groups and rules
- ▶ change the order of existing rules

Perform the following steps:

- Open the *Network Security > ACL > MAC Rule* dialog.
- Click the  button.  
The dialog displays the *Create* window.
- To create a group, specify a meaningful name in the *Group name* field. You can combine several rules in one group.
- To add a rule to an existing group, select the name of the group in the *Group name* field.
- In the *Index* field you specify the number for the rule within the ACL.  
This number defines the priority of the rule.
- Click the *Ok* button.  
The device adds the rule to the table.  
Group and role are active immediately.  
To deactivate group or rules, unmark the checkbox in the *Active* column.  
To remove a rule, highlight the affected table entry and click the  button.
- Edit the rule parameters in the table.  
To change a value, double-click the relevant field.
- Save the changes temporarily. To do this, click the  button.

**Note:** In the *Source MAC address* and *Destination MAC address* fields you can use wildcards in the `FF:?:?:?:?:?:?:?` or `?:?:?:?:?:?:00:01` form. Use capital letters here.

### 8.2.4 Creating and configuring a MAC ACL using the Command Line Interface

In the following example, AppleTalk and IPX are to be filtered out from the entire network. To do this, perform the following steps:

<code>enable</code>	Change to the Privileged EXEC mode.
<code>configure</code>	Change to the Configuration mode.
<code>mac acl add 1 macfilter</code>	Adds an MAC ACL with the ID 1 and the name <i>macfilter</i> .



<pre>mac acl rule add 1 1 deny src any any dst any any etype appletalk</pre>	<p>Adds a rule to position <b>1</b> of the MAC ACL with the ID <b>1</b> rejecting packets with EtherType <b>0x809B</b> (<b>AppleTalk</b>).</p>
<pre>mac acl rule add 1 2 deny src any any dst any any etype ipx-old</pre>	<p>Adds a rule to position <b>2</b> of the MAC ACL with the ID <b>1</b> rejecting packets with EtherType <b>0x8137</b> (<b>IPX alt</b>).</p>
<pre>mac acl rule add 1 3 deny src any any dst any any etype ipx-new</pre>	<p>Adds a rule to position <b>3</b> of the MAC ACL with the ID <b>1</b> rejecting packets with EtherType <b>0x8138</b> (<b>IPX</b>).</p>
<pre>mac acl rule add 1 4 permit src any any dst any any</pre>	<p>Adds a rule to position <b>4</b> of the MAC ACL with the ID <b>1</b> forwarding packets.</p>
<pre>show acl mac rules 1</pre>	<p>Displays the rules of the MAC ACL with the ID <b>1</b>.</p>
<pre>interface 1/1,1/2,1/3,1/4,1/5,1/6</pre>	<p>Change to the interface configuration mode of the interfaces <b>1/1</b> to <b>1/6</b>.</p>
<pre>acl mac assign 1 in 1</pre>	<p>Assigns the MAC ACL with the ID <b>1</b> to incoming data packets (<b>1/1</b>) on interfaces <b>1/6</b> to <b>in</b>.</p>
<pre>exit</pre>	<p>Leaves the interface mode.</p>
<pre>show acl mac assignment 1</pre>	<p>Displays the assignment of the MAC ACL with the ID <b>1</b> to interfaces or VLANs.</p>

### 8.2.5 Assigning ACLs to a port or VLAN

When you assign ACLs to a port or VLAN, the device gives you the following options:

- ▶ To select the port or VLAN.
- ▶ To specify the ACL priority.
- ▶ To select the ACL using the group name.

Perform the following steps:

- Open the *Network Security > ACL > Assignment* dialog.
- Click the  button.  
The dialog displays the *Create* window.
  - In the *Port/VLAN* field, specify the desired port or the desired VLAN.
  - In the *Priority* field, specify the priority.
  - In the *Direction* field, specify the data packets to which the device applies the rule.
  - In the *Group name* field, specify the rule the device assigns to the port or the VLAN.
- Click the *Ok* button.
- Save the changes temporarily. To do this, click the  button.



## 9 Synchronizing the system time in the network

Many applications rely on a time that is as correct as possible. The necessary accuracy, and thus the allowable deviation from the actual time, depends on the application area.

Examples of application areas include:

- ▶ Log entries
- ▶ Time stamping of production data
- ▶ Process control

The device lets you synchronize the time on the network using the following options:

- ▶ The Simple Network Time Protocol (SNTP) is a simple solution for low accuracy requirements. Under ideal conditions, SNTP achieves an accuracy in the millisecond range. The accuracy depends on the signal delay.
- ▶ IEEE 1588 with the Precision Time Protocol (PTP) achieves accuracies on the order of fractions of microseconds. This method is suitable even for demanding applications up to and including process control.

When the involved devices support the PTP protocol, it is the better choice. PTP is more accurate, has advanced methods of error correction, and causes a low network load. The implementation of PTP is comparatively easy.

**Note:** According to the PTP and SNTP standards, both protocols function in parallel in the same network. However, since both protocols influence the system time of the device, situations can occur in which the two protocols conflict with each other.

### 9.1 Basic settings

In the *Time > Basic Settings* dialog, you specify general settings for the time.

#### 9.1.1 Setting the time

When no reference time source is available to you, you have the option to set the time in the device.

After a cold start or reboot, if no real-time clock is available or the real-time clock contains an invalid time, then the device initializes its clock with January 1, 00:00h. After the power supply is switched off, the device buffers the settings of the real-time clock up to 24 hours.

Alternatively, you configure the settings in the device so that it automatically obtains the current time from a PTP clock or from an SNTP server.

Alternatively, you configure the settings in the device so that it automatically obtains the current time from an SNTP server.



Perform the following steps:

- Open the *Time > Basic Settings* dialog.
    - ▶ The *System time (UTC)* field displays the current UTC (Universal Time Coordinated) of the device. UTC is the time relating to the coordinated world time measurement. UTC is the same worldwide and does not take local time shifts into account.
    - ▶ The time in the *System time* field comes from the *System time (UTC)* plus the *Local offset [min]* value and a possible shift due to daylight saving time.
  
  - In order to cause the device to apply the time of your PC to the *System time* field, click the *Set time from PC* button.

Based on the value in the *Local offset [min]* field, the device calculates the time in the *System time (UTC)* field: The *System time (UTC)* comes from the *System time* minus the *Local offset [min]* value and a possible shift due to daylight saving time.

    - ▶ The *Time source* field displays the origin of the time data. The device automatically selects the source with the greatest accuracy.

The source is initially *local*.  
When SNTP is active and the device receives a valid SNTP packet, the device sets its time source to *sntp*.  
When PTP is active and the device receives a valid PTP message, the device sets its time source to *ptp*. The device prioritizes PTP ahead of SNTP.
    - ▶ The *Local offset [min]* value specifies the time difference between the local time and the *System time (UTC)*.
  
  - In order to cause the device to determine the time zone on your PC, click the *Set time from PC* button. The device calculates the local time difference from UTC and enters the difference into the *Local offset [min]* field.
- Note:** The device provides the option to obtain the local offset from a DHCP server.
- Save the changes temporarily. To do this, click the  button.

```
enable
configure
clock set <YYYY-MM-DD> <HH:MM:SS>
clock timezone offset <-780..840>

save
```

Change to the Privileged EXEC mode.

Change to the Configuration mode.

Set the system time of the device.

Enter the time difference between the local time and the received UTC time in minutes.

Save the settings in the non-volatile memory (*nvm*) in the “selected” configuration profile.

## 9.1.2 Automatic daylight saving time changeover

When you operate the device in a time zone in which there is a summer time change, you set up the automatic daylight saving time changeover on the *Daylight saving time* tab.

When daylight saving time is enabled, the device sets the local system time forward by 1 hour at the beginning of daylight saving time. At the end of daylight saving time, the device sets the local system time back again by 1 hour. To do this, perform the following steps:

- Open the *Time > Basic Settings* dialog, *Daylight saving time* tab.
- To select a preset profile for the start and end of daylight saving time, click the *Profile...* button in the *Operation* frame.
- When no matching daylight saving time profile is available, you specify the changeover times in the *Summertime begin* and *Summertime end* fields.  
For both time points, you specify the month, the week within this month, the weekday, and the time of day.
- To enable the function, select the *On* radio button in the *Operation* frame.
- Save the changes temporarily. To do this, click the  button.

```
enable
configure
clock summer-time mode
<disable|recurring|eu|usa>

clock summer-time recurring start
clock summer-time recurring end
save
```

Change to the Privileged EXEC mode.

Change to the Configuration mode.

Configure the automatic daylight saving time changeover: enable/disable or activate with a profile.

Enter the start time for the changeover.

Enter the end time for the changeover.

Save the settings in the non-volatile memory (nvm) in the “selected” configuration profile.

## 9.2 SNTP

The Simple Network Time Protocol (SNTP) lets you synchronize the system time in your network. The device supports the SNTP client and the SNTP server function.

The SNTP server makes the UTC (Universal Time Coordinated) available. UTC is the time relating to the coordinated world time measurement. The UTC is the same worldwide and ignores local time shifts.

SNTP is a simplified version of NTP (Network Time Protocol). The data packets are identical with SNTP and NTP. Accordingly, both NTP and SNTP servers serve as a time source for SNTP clients.

**Note:** Statements in this chapter relating to external SNTP servers also apply to NTP servers.

SNTP knows the following operation modes for the transmission of time:

- ▶ **Unicast**  
In *Unicast* operation mode, an SNTP client sends requests to an SNTP server and expects a response from this server.
- ▶ **Broadcast**  
In *Broadcast* operation mode, an SNTP server sends SNTP messages to the network in specified intervals. SNTP clients receive these SNTP messages and evaluate them.

Table 15: Target IPv4 address classes for Broadcast operation mode

IPv4 destination address	Send SNTP packets to
0.0.0.0	Nobody
224.0.1.1	<i>Multicast</i> address for SNTP messages
255.255.255.255	<i>Broadcast</i> address

**Note:** An SNTP server in *Broadcast* operation mode also responds to direct requests using *Unicast* from SNTP clients. In contrast, SNTP clients work in either *Unicast* or *Broadcast* operation mode.

### 9.2.1 Preparation

Perform the following steps:

- To get an overview of how the time is passed on, draw a network plan with the devices participating in SNTP.

When planning, bear in mind that the accuracy of the time depends on the delays of the SNTP messages. To minimize delays and their variance, place an SNTP server in each network segment. Each of these SNTP servers synchronizes its own system time as an SNTP client with its parent SNTP server (SNTP cascade). The highest SNTP server in the SNTP cascade has the most direct access to a reference time source.

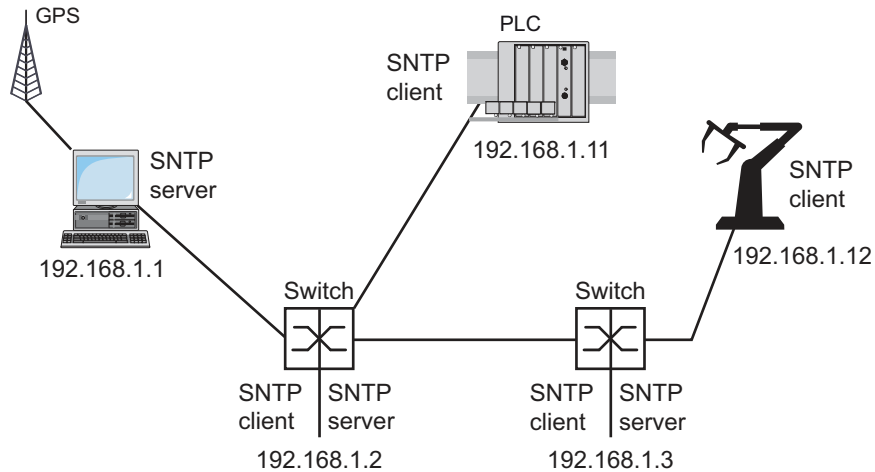

Figure 19: Example of SNTP cascade

**Note:** For precise time distribution, between SNTP servers and SNTP clients you preferably use network components (routers and switches) that forward the SNTP packets with a low and uniform transmission time (latency).

- ▶ An SNTP client sends its requests to up to 4 configured SNTP servers. When there is no response from the 1st SNTP server, the SNTP client sends its requests to the 2nd SNTP server. When this request is also unsuccessful, it sends the request to the 3rd and finally the 4th SNTP server. If none of these SNTP servers respond, the SNTP client loses its synchronization. The SNTP client periodically sends requests to each SNTP server until a server delivers a valid time.

**Note:** The device provides the option of obtaining a list of SNTP server IP addresses from a DHCP server.

- If no reference time source is available to you, then determine a device with an SNTP server as a reference time source. Adjust its system time at regular intervals.

### 9.2.2 Defining settings of the SNTP client

As an SNTP client, the device obtains the time information from SNTP or NTP servers and synchronizes its system clock accordingly. To do this, perform the following steps:



- Open the *Time > SNTP > Client* dialog.
- Set the SNTP operation mode.  
In the *Configuration* frame, select one of the following values in the *Mode* field:
  - ▶ *unicast*  
The device sends requests to an SNTP server and expects a response from this server.
  - ▶ *broadcast*  
The device waits for *Broadcast* or *Multicast* messages from SNTP servers on the network.
- To synchronize the time only once, mark the *Disable client after successful sync* checkbox. After synchronization, the device disables the *SNTP Client* function.
- ▶ The table displays the SNTP server to which the SNTP client sends a request in *Unicast* operation mode. The table contains up to 4 SNTP server definitions.
- To add a table entry, click the  button.
- Specify the connection data of the SNTP server.
- To enable the function, select the *On* radio button in the *Operation* frame.
- Save the changes temporarily. To do this, click the  button.
- ▶ The *State* field displays the current status of the *SNTP Client* function.

Table 16: SNTP client settings for the example

Device	192.168.1.1	192.168.1.2	192.168.1.3	192.168.1.11	192.168.1.12
<i>SNTP Client</i> function	<i>Off</i>	<i>On</i>	<i>On</i>	<i>On</i>	<i>On</i>
<i>Configuration: Mode</i>	<i>unicast</i>	<i>unicast</i>	<i>unicast</i>	<i>unicast</i>	<i>unicast</i>
<i>Request interval [s]</i>	30	30	30	30	30
<i>SNTP Server</i> address(es)	-	192.168.1.1	192.168.1.2	192.168.1.2	192.168.1.3
			192.168.1.1	192.168.1.1	192.168.1.2
					192.168.1.1

### 9.2.3 Specifying SNTP server settings

When the device operates as an SNTP server, it provides its system time in coordinated world time (UTC) in the network. To do this, perform the following steps:

- Open the *Time > SNTP > Server* dialog.
- To enable the function, select the *On* radio button in the *Operation* frame.
- To enable the *Broadcast* operation mode, select the *Broadcast admin mode* radio button in the *Configuration* frame.  
In *Broadcast* operation mode, the SNTP server sends SNTP messages to the network in specified intervals. The SNTP server also responds to the requests from SNTP clients in *Unicast* operation mode.
  - In the *Broadcast destination address* field, you set the IPv4 address to which the SNTP server sends the SNTP packets. Set a *Broadcast* address or a *Multicast* address.
  - In the *Broadcast UDP port* field, you specify the number of the UDP port to which the SNTP server sends the SNTP packets in *Broadcast* operation mode.
  - In the *Broadcast VLAN ID* field, you specify the ID of the VLAN to which the SNTP server sends the SNTP packets in *Broadcast* operation mode.
  - In the *Broadcast send interval [s]* field, you enter the time interval at which the SNTP server of the device sends SNTP *Broadcast* packets.
- Save the changes temporarily. To do this, click the  button.
- ▶ The *State* field displays the current status of the *SNTP Server* function.

Table 17: Settings for the example

Device	192.168.1.1	192.168.1.2	192.168.1.3	192.168.1.11	192.168.1.12
<i>SNTP Server function</i>	<i>On</i>	<i>On</i>	<i>On</i>	<i>Off</i>	<i>Off</i>
<i>UDP port</i>	123	123	123	123	123
<i>Broadcast admin mode</i>	unmarked	unmarked	unmarked	unmarked	unmarked
<i>Broadcast destination address</i>	0.0.0.0	0.0.0.0	0.0.0.0	0.0.0.0	0.0.0.0
<i>Broadcast UDP port</i>	123	123	123	123	123
<i>Broadcast VLAN ID</i>	1	1	1	1	1
<i>Broadcast send interval [s]</i>	128	128	128	128	128
<i>Disable server at local time source</i>	unmarked	unmarked	unmarked	unmarked	unmarked

## 9.3 PTP

In order for LAN-controlled applications to work without latency, precise time management is required. With PTP (Precision Time Protocol), IEEE 1588 describes a method that enables precise synchronization of clocks in the network.

PTP enables synchronization with an accuracy of a few 100 ns. PTP uses Multicasts for the synchronization messages, which keeps the network load low.

### 9.3.1 Types of clocks

PTP defines the roles of “master” and “slave” for the clocks in the network:

- ▶ A master clock (reference time source) distributes its time.
- ▶ A slave clock synchronizes itself with the timing signal received from the master clock.

#### Boundary clock

The transmission time (latency) in routers and switches has a measurable effect on the precision of the time transmission. To correct such inaccuracies, PTP defines what are known as boundary clocks.

In a network segment, a boundary clock is the reference time source (master clock) to which the subordinate slave clocks synchronize. Typically routers and switches take on the role of boundary clock.

The boundary clock in turn obtains the time from a higher-level reference time source (Grandmaster).

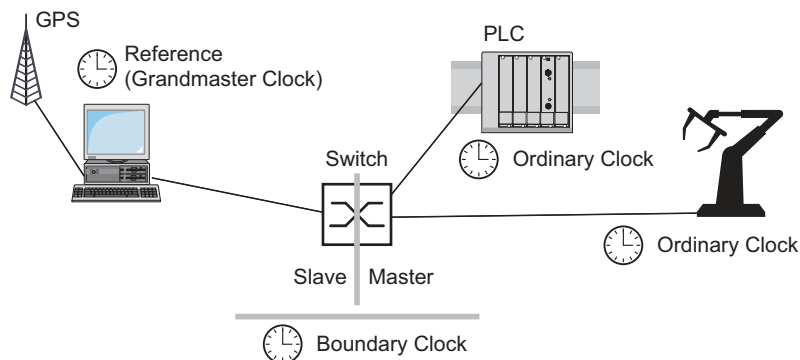

Figure 20: Position of the boundary clock in a network

#### Transparent Clock

Switches typically take on the Transparent Clock role to enable high accuracy across the cascades. The Transparent Clock is a Slave clock that corrects its own transmission time when it forwards received synchronization messages.

## Ordinary Clock

PTP designates the clock in an end device as an “Ordinary Clock”. An Ordinary Clock functions either as a master clock or slave clock.

### 9.3.2 Best Master Clock algorithm

The devices participating in PTP designate a device in the network as a reference time source (Grandmaster). Here the “Best Master Clock” algorithm is used, which determines the accuracy of the clocks available in the network.

The “Best Master Clock” algorithm evaluates the following criteria:

- ▶ *Priority 1*
- ▶ *Clock class*
- ▶ *Clock accuracy*
- ▶ *Clock variance*
- ▶ *Priority 2*

The algorithm first evaluates the value in the *Priority 1* field of the participating devices. The device with the smallest value in the *Priority 1* field becomes the reference time source (Grandmaster). When the value is the same for multiple devices, the algorithm takes the next criterion. When this is also the same, it takes the next criterion after this one. If these values are the same for multiple devices, then the smallest value in the *Clock identity* field decides which device becomes the reference time source (Grandmaster).

In the settings of the boundary clock, the device lets you individually specify the values for *Priority 1* and *Priority 2*. This lets you influence which device will be the reference time source (Grandmaster) in the network.

### 9.3.3 Delay measurement

The delay of the synchronization messages between the devices affects the accuracy. The delay measurement lets the devices take into account the average delay.

PTP version 2 offers the following methods for delay measurement:

- ▶ *e2e* (End to End)  
The slave clock measures the delay of synchronization messages to the master clock.
- ▶ *e2e-optimized*  
The slave clock measures the delay of synchronization messages to the master clock. This method is available only for transparent clocks. The device forwards the synchronization messages sent using Multicast only to the master clock, keeping the network load low. When the device receives a synchronization message from another master clock, it forwards the synchronization messages only to this new port. When the device knows no master clock, it forwards synchronization messages to every port.
- ▶ *p2p* (Peer to Peer)  
The slave clock measures the delay of synchronization messages to the master clock. In addition, the master clock measures the delay to each slave clock, even across blocked ports. This requires that the master and slave clock support Peer-to-Peer (*p2p*). In case of interruption of a redundant ring, for example, the slave clock becomes the master clock and the master clock becomes the slave clock. This switch occurs without loss of precision, because the clocks already know the delay in the other direction.



### 9.3.4 PTP domains

The device transmits synchronization messages only from and to devices in the same PTP domain. The device lets you set the domain for the boundary clock and for the transparent clock individually.

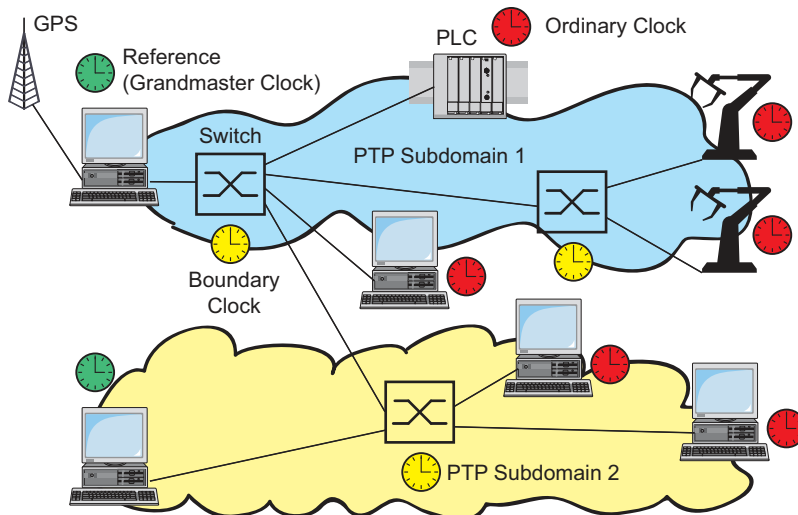

Figure 21: Example of PTP domains

### 9.3.5 Using PTP

In order to synchronize the clocks precisely with PTP, only use switches with a boundary clock or transparent clock as nodes.

Perform the following steps:

- To gain an overview of the distribution of clocks, draw a network plan with the devices involved in PTP.
- Specify the role for each participating switch (boundary clock or transparent clock). In the device, this setting is called *PTP mode*.

Table 18: Possible settings for PTP mode

PTP mode	Application
<code>v2-boundary-clock</code>	As a boundary clock, the device distributes synchronization messages to the slave clocks in the subordinate network segment. The boundary clock in turn obtains the time from a higher-level reference time source (Grandmaster).
<code>v2-transparent-clock</code>	As a transparent clock, the device forwards received synchronization messages after they have been corrected by the delay of the transparent clock.

- Enable PTP on each participating switch. PTP is then configured on a largely automatic basis.
- Enable PTP on the end devices.
- The device lets you influence which device in the network becomes the reference clock (Grandmaster). Therefore, change the default value in the *Priority 1* and *Priority 2* fields for the *Boundary Clock*.

## 10 Network load control

The device features a number of functions that can help you reduce the network load:

- ▶ Direct packet distribution
- ▶ Multicasts
- ▶ Rate limiter
- ▶ Prioritization - QoS
- ▶ Flow control

### 10.1 Direct packet distribution

The device reduces the network load with direct packet distribution.

On each of its ports, the device learns the sender MAC address of received data packets. The device stores the combination “port and MAC address” in its MAC address table (FDB).

By applying the “Store and Forward” method, the device buffers data received and checks it for validity before forwarding it. The device rejects invalid and defective data packets.

#### 10.1.1 Learning MAC addresses

When the device receives a data packet, it checks if the MAC address of the sender is already stored in the MAC address table (FDB). When the MAC address of the sender is unknown, the device generates a new entry. The device then compares the destination MAC address of the data packet with the entries stored in the MAC address table (FDB):

- ▶ The device forwards packets with a known destination MAC address directly to ports that have already received data packets from this MAC address.
- ▶ The device floods data packets with unknown destination addresses, that is, the device forwards these data packets to every port.

#### 10.1.2 Aging of learned MAC addresses

Addresses that have not been detected by the device for an adjustable period of time (aging time) are deleted from the MAC address table (FDB) by the device. A reboot or resetting of the MAC address table deletes the entries in the MAC address table (FDB).

#### 10.1.3 Static address entries



In addition to learning the sender MAC address, the device also provides the option to set MAC addresses manually. These MAC addresses remain configured and survive resetting of the MAC address table (FDB) as well as rebooting of the device.

Static address entries allow the device to forward data packets directly to selected ports. If you do not specify a destination port, then the device discards the corresponding data packets.

You manage the static address entries in the Graphical User Interface or in the Command Line Interface.

Perform the following steps:

- Create a static address entry.

- Open the *Switching > Filter for MAC Addresses* dialog.
- Add a user-configurable MAC address:
  - ▶ Click the  button.  
The dialog displays the *Create* window.
  - ▶ In the *Address* field, specify the destination MAC address.
  - ▶ In the *VLAN ID* field, specify the ID of the VLAN.
  - ▶ In the *Port* list, select the ports to which the device forwards data packets with the specified destination MAC address in the specified VLAN.  
When you have defined a Unicast MAC address in the *Address* field, select only one port.  
When you have defined a Multicast MAC address in the *Address* field, select one or more ports.  
If you want the device to discard data packets with the destination MAC address, then do not select any port.
  - ▶ Click the *Ok* button.
- Save the changes temporarily. To do this, click the  button.

<code>enable</code>	Change to the Privileged EXEC mode.
<code>configure</code>	Change to the Configuration mode.
<code>mac-filter &lt;MAC address&gt; &lt;VLAN ID&gt;</code>	Create the MAC address filter, consisting of a MAC address and VLAN ID.
<code>interface 1/1</code>	Change to the interface configuration mode of interface 1/1.
<code>mac-filter &lt;MAC address&gt; &lt;VLAN ID&gt;</code>	Assign the port to a previously created MAC address filter.
<code>save</code>	Save the settings in the non-volatile memory ( <i>nvm</i> ) in the “selected” configuration profile.

- Convert a learned MAC address into a static address entry.

- Open the *Switching > Filter for MAC Addresses* dialog.
- To convert a learned MAC address into a static address entry, select the value *permanent* in the *Status* column.
- Save the changes temporarily. To do this, click the  button.

- Disable a static address entry.

- Open the *Switching > Filter for MAC Addresses* dialog.
- To disable a static address entry, select the value *invalid* in the *Status* column.
- Save the changes temporarily. To do this, click the  button.

enable	Change to the Privileged EXEC mode.
configure	Change to the Configuration mode.
interface 1/1	Change to the interface configuration mode of interface 1/1.
no mac-filter <MAC address> <VLAN ID>	Cancel the assignment of the MAC address filter on the port.
exit	Change to the Configuration mode.
no mac-filter <MAC address> <VLAN ID>	Deleting the MAC address filter, consisting of a MAC address and VLAN ID.
exit	Change to the Privileged EXEC mode.
save	Save the settings in the non-volatile memory (nvm) in the "selected" configuration profile.

Delete learned MAC addresses.

To delete the learned addresses from the MAC address table (FDB), open the [Basic Settings > Restart](#) dialog and click the [Reset MAC address table](#) button.

clear mac-addr-table	Delete the learned MAC addresses from the MAC address table (FDB).
----------------------	--

## 10.2 Multicasts

By default, the device floods data packets with a Multicast address, that is, the device forwards the data packets to every port. This leads to an increased network load.

The use of IGMP snooping can reduce the network load caused by Multicast data traffic. IGMP snooping lets the device send Multicast data packets only on those ports to which devices “interested” in Multicast are connected.

### 10.2.1 Example of a Multicast application

Surveillance cameras transmit images to monitors in the machine room and in the monitoring room. With an IP Multicast transmission, the cameras transmit their graphic data over the network in Multicast packets.

The Internet Group Management Protocol (IGMP) organizes the Multicast data traffic between the Multicast routers and the monitors. The switches in the network between the Multicast routers and the monitors monitor the IGMP data traffic continuously (“IGMP Snooping”).

Switches register logins for receiving a Multicast stream (IGMP report). The device then creates an entry in the MAC address table (FDB) and forwards Multicast packets only to the ports on which it has previously received IGMP reports.

### 10.2.2 IGMP snooping

The Internet Group Management Protocol (IGMP) describes the distribution of Multicast information between routers and connected receivers on Layer 3. IGMP Snooping describes the function of a switch of continuously monitoring IGMP traffic and optimizing its own transmission settings for this data traffic.

The *IGMP Snooping* function in the device operates according to RFC 4541 (Considerations for Internet Group Management Protocol (IGMP) and Multicast Listener Discovery (MLD) Snooping Switches).

Multicast routers with an active *IGMP* function periodically request (query) registration of Multicast streams in order to determine the associated IP Multicast group members. IP Multicast group members reply with a Report message. This Report message contains the parameters required by the *IGMP* function. The Multicast router enters the IP Multicast group address from the Report message in its routing table. This causes it to forward data packets with this IP Multicast group in the destination address field according to its routing table.

When leaving a Multicast group (IGMP version 2 and higher), receivers log out with a “Leave” message and do not send any more Report messages. If it does not receive any more Report messages from this receiver within a certain time (aging time), then the Multicast router removes the routing table entry of a receiver.

When several IGMP Multicast routers are in the same network, the device with the smaller IP address takes over the query function. When there are no Multicast routers on the network, you have the option to enable the query function in an appropriately equipped switch.

A switch that connects one Multicast receiver with a Multicast router analyzes the IGMP information with the IGMP snooping method.

The IGMP snooping method also makes it possible for switches to use the *IGMP* function. A switch stores the MAC addresses derived from IP addresses of the Multicast receivers as recognized Multicast addresses in its MAC address table (FDB). In addition, the switch identifies the ports on which it has received reports for a specific Multicast address. In this way, the switch forwards Multicast packets only to ports to which Multicast receivers are connected. The other ports do not receive these packets.

A special feature of the device is the possibility of determining the processing of data packets with unknown Multicast addresses. Depending on the setting, the device discards these data packets or forwards them to every port. By default, the device transmits the data packets only to ports with connected devices, which in turn receive query packets. You also have the option of additionally sending known Multicast packets to query ports.

### Setting IGMP snooping

Perform the following steps:

- Open the *Switching > IGMP Snooping > Global* dialog.
  - To enable the function, select the *On* radio button in the *Operation* frame.
- When the *IGMP Snooping* function is disabled, the device behaves as follows:
- ▶ The device ignores the received query and report messages.
  - ▶ The device forwards (floods) received data packets with a Multicast address as the destination address to every port.
- Save the changes temporarily. To do this, click the  button.

Specifying the settings for a port:

- Open the *Switching > IGMP Snooping > Configuration* dialog, *Port* tab.
- To activate the *IGMP Snooping* function on a port, mark the checkbox in the *Active* column for the relevant port.
- Save the changes temporarily. To do this, click the  button.

Specifying the settings for a VLAN:

- Open the *Switching > IGMP Snooping > Configuration* dialog, *VLAN ID* tab.
- To activate the *IGMP Snooping* function for a specific VLAN, mark the checkbox in the *Active* column for the relevant VLAN.
- Save the changes temporarily. To do this, click the  button.

### Setting the IGMP querier function

The device itself optionally sends active query messages; alternatively, it responds to query messages or detects other Multicast queriers in the network (*IGMP Snooping Querier* function).

Prerequisite:

The *IGMP Snooping* function is enabled globally.

Perform the following steps:

- Open the *Switching > IGMP Snooping > Querier* dialog.
- In the *Operation* frame, enable/disable the *IGMP Snooping Querier* function of the device globally.
- To activate the *IGMP Snooping Querier* function for a specific VLAN, mark the checkbox in the *Active* column for the relevant VLAN.
  - ▶ The device carries out a simple selection process: When the IP source address of the other Multicast querier is lower than its own, the device switches to the passive state, in which it does not send out any more query requests.
  - ▶ In the *Address* column, you specify the IP Multicast address that the device inserts as the sender address in generated query requests. You use the address of the Multicast router.
- Save the changes temporarily. To do this, click the  button.

### IGMP snooping enhancements (table)

The *Switching > IGMP Snooping > Snooping Enhancements* dialog provides you access to enhanced settings for the *IGMP Snooping* function. You activate or deactivate the settings on a per port basis in a VLAN.

The following settings are possible:

- ▶ *Static*  
Use this setting to set the port as a static query port. The device forwards every IGMP message on a static query port, even if it has previously received no IGMP query messages on this port. When the static option is disabled and the device has previously received IGMP query messages, it forwards IGMP messages on this port. When this is the case, the entry displays **L** (“learned”).
- ▶ *Learn by LLDP*  
A port with this setting automatically discovers other Hirschmann devices using LLDP (Link Layer Discovery Protocol). The device then learns the IGMP query status of this port from these Hirschmann devices and configures the *IGMP Snooping Querier* function accordingly. The **ALA** entry indicates that the *Learn by LLDP* function is activated. When the device has found another Hirschmann device on this port in this VLAN, the entry also displays an **A** (“automatic”).
- ▶ *Forward All*  
With this setting, the device forwards the data packets addressed to a Multicast address to this port. The setting is suitable in the following situations, for example:
  - For diagnostic purposes.
  - For devices in an MRP ring: After the ring is switched, the *Forward All* function makes it possible to reconfigure the network rapidly for data packets with registered Multicast destination addresses. Activate the *Forward All* function on every ring port.

Prerequisite:

The *IGMP Snooping* function is enabled globally.

Perform the following steps:

- Open the *Switching > IGMP Snooping > Snooping Enhancements* dialog.
- Double-click the desired port in the desired VLAN.

- To activate one or more functions, select the corresponding options.
- Click the *Ok* button.
- Save the changes temporarily. To do this, click the  button.

```
enable
```

```
vlan database
```

```
igmp-snooping vlan-id 1 forward-all 1/1
```

Change to the Privileged EXEC mode.

Change to the VLAN configuration mode.

Activate the *Forward All* function for port *1/1* in VLAN *1*.

## Configure Multicasts

The device lets you configure the exchange of Multicast data packets. The device provides different options depending on whether the data packets are to be sent to unknown or known Multicast receivers.

The settings for unknown Multicast addresses are global for the entire device. The following options can be selected:

- ▶ The device discards unknown Multicasts.
- ▶ The device forwards unknown Multicasts to every port.
- ▶ The device forwards unknown Multicasts only to ports that have previously received query messages (query ports).

**Note:** The exchange settings for unknown Multicast addresses also apply to the reserved IP addresses from the “Local Network Control Block” (224.0.0.0..224.0.0.255). This behavior can affect higher-level routing protocols.

For each VLAN, you specify the sending of Multicast packets to known Multicast addresses individually. The following options can be selected:

- ▶ The device forwards known Multicasts to the ports that have previously received query messages (query ports) and to the registered ports. Registered ports are ports with Multicast receivers registered with the corresponding Multicast group. This option helps ensure that the transfer works with basic applications without further configuration.
- ▶ The device forwards known Multicasts only to the registered ports. The advantage of this setting is that it uses the available bandwidth optimally through direct distribution.

Prerequisite:

The *IGMP Snooping* function is enabled globally.

Perform the following steps:

- Open the *Switching > IGMP Snooping > Multicasts* dialog.



- In the *Configuration* frame, you specify how the device sends data packets to unknown Multicast addresses.
  - ▶ *send to registered ports*  
The device forwards packets with unknown Multicast address to every query port.
  - ▶ *send to query and registered ports*  
The device forwards packets with unknown Multicast address to every port.
- In the *Known multicasts* column, you specify how the device sends data packets to known Multicast addresses in the corresponding VLAN. Click the relevant field and select the desired value.
- Save the changes temporarily. To do this, click the  button.

## 10.3 Rate limiter

The rate limiter function helps ensure stable operation even with high traffic volumes by limiting traffic on the ports. The rate limitation is performed individually for each port, as well as separately for inbound and outbound traffic.

If the data rate on a port exceeds the defined limit, then the device discards the overload on this port.

Rate limitation occurs entirely on Layer 2. In the process, the rate limiter function ignores protocol information on higher levels such as IP or TCP. This can affect the TCP traffic.

To minimize these effects, use the following options:

- ▶ Limit the rate limitation to certain packet types, for example, Broadcasts, Multicasts, and Unicasts with an unknown destination address.
- ▶ Limit the outbound data traffic instead of the inbound traffic. The outbound rate limitation works better with TCP flow control due to device-internal buffering of the data packets.
- ▶ Increase the aging time for learned Unicast addresses.

Perform the following steps:

- Open the *Switching > Rate Limiter* dialog.
- ▶ Activate the rate limiter and set limits for the data rate. The settings apply on a per port basis and are broken down by type of traffic:
  - ▶ Received Broadcast data packets
  - ▶ Received Multicast data packets
  - ▶ Received Unicast data packets with an unknown destination addressTo activate the rate limiter on a port, mark the checkbox for at least one category. In the *Threshold unit* column, you specify if the device interpretes the threshold values as percent of the port bandwidth or as packets per second. The threshold value 0 deactivates the rate limiter.
- Save the changes temporarily. To do this, click the  button.

## 10.4 QoS/Priority

QoS (Quality of Service) is a procedure defined in IEEE 802.1D which is used to distribute resources in the network. QoS lets you prioritize the data of necessary applications.

When there is a heavy network load, prioritizing helps prevent data traffic with lower priority from interfering with delay-sensitive data traffic. Delay-sensitive data traffic includes, for example, voice, video, and real-time data.

### 10.4.1 Description of prioritization

For data traffic prioritization, traffic classes are defined in the device. The device prioritizes higher traffic classes over lower traffic classes. The number of traffic classes depends on the device type.

To provide for optimal data flow for delay-sensitive data, you assign higher traffic classes to this data. You assign lower traffic classes to data that is less sensitive to delay.

#### Assigning traffic classes to the data

The device automatically assigns traffic classes to inbound data (traffic classification). The device takes the following classification criteria into account:

- ▶ Methods according to which the device carries out assignment of received data packets to traffic classes:
  - ▶ `trustDot1p`  
The device uses the priority of the data packet contained in the VLAN tag.
  - ▶ `trustIpDscp`  
The device uses the QoS information contained in the IP header (ToS/DiffServ).
  - ▶ `untrusted`  
The device ignores possible priority information within the data packets and uses the priority of the receiving port directly.
- ▶ The priority assigned to the receiving port.

Both classification criteria are configurable.

During traffic classification, the device uses the following rules:

- ▶ When the receiving port is set to `trustDot1p` (default setting), the device uses the data packet priority contained in the VLAN tag. When the data packets do not contain a VLAN tag, the device is guided by the priority of the receiving port.
- ▶ When the receiving port is set to `trustIpDscp`, the device uses the QoS information (ToS/DiffServ) in the IP header. When the data packets do not contain IP packets, the device is guided by the priority of the receiving port.
- ▶ When the receiving port is set to `untrusted`, the device is guided by the priority of the receiving port.

## Prioritizing traffic classes

For prioritization of traffic classes, the device uses the following methods:

- ▶ **Strict**  
When transmission of data of a higher traffic class is no longer taking place or the relevant data is still in the queue, the device sends data of the corresponding traffic class. If every traffic class is prioritized according to the **Strict** method, then under high network load the device can permanently block the data of lower traffic classes.
- ▶ **Weighted Fair Queuing**  
The traffic class is assigned a specific bandwidth. This helps ensure that the device sends the data traffic of this traffic class, although there is a great deal of data traffic in higher traffic classes.

### 10.4.2 Handling of received priority information

Applications label data packets with the following prioritization information:

- ▶ VLAN priority based on IEEE 802.1Q/ 802.1D (Layer 2)
- ▶ Type-of-Service (ToS) or DiffServ (DSCP) for VLAN Management IP packets (Layer 3)

The device lets you evaluate this priority information using the following options:

- ▶ **trustDot1p**  
The device assigns VLAN-tagged data packets to the different traffic classes according to their VLAN priorities. The corresponding allocation is configurable. The device assigns the priority of the receiving port to data packets it receives without a VLAN tag.
- ▶ **trustIpDscp**  
The device assigns the IP packets to the different traffic classes according to the DSCP value in the IP header, although the packet was also VLAN-tagged. The corresponding allocation is configurable. The device prioritizes non-IP packets according to the priority of the receiving port.
- ▶ **untrusted**  
The device ignores the priority information in the data packets and assigns the priority of the receiving port to them.

### 10.4.3 VLAN tagging

For the VLAN and prioritizing functions, the IEEE 802.1Q standard provides for integrating a MAC frame in the VLAN tag. The VLAN tag consists of 4 bytes and is between the source address field (“Source Address Field”) and type field (“Length / Type Field”).

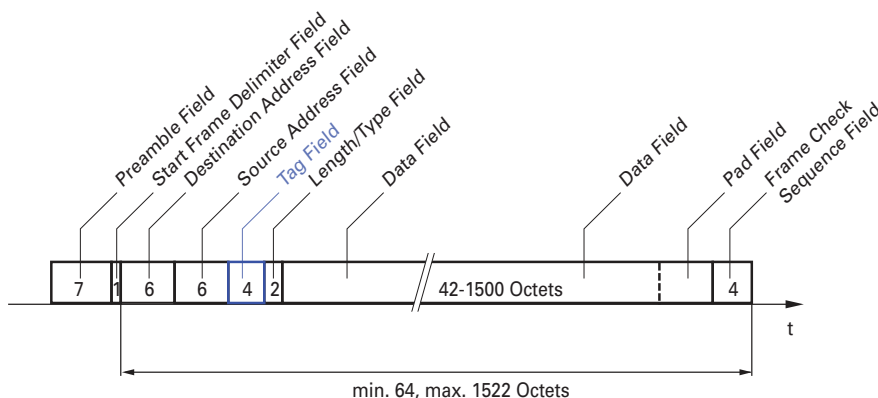

Figure 22: Ethernet data packet with tag

For data packets with VLAN tags, the device evaluates the following information:

- ▶ Priority information
- ▶ When VLANs are configured, VLAN tagging

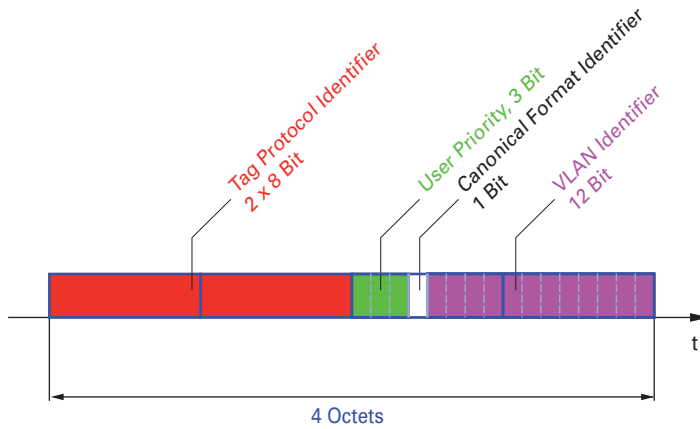

Figure 23: Structure of the VLAN tagging

Data packets with VLAN tags containing priority information but no VLAN information (VLAN ID = 0), are known as Priority Tagged Frames.

**Note:** Network protocols and redundancy mechanisms use the highest traffic class 7. Therefore, select other traffic classes for application data.

When using VLAN prioritizing, consider the following special features:

- ▶ End-to-end prioritizing requires the VLAN tags to be transmitted to the entire network. The prerequisite is that every network component is VLAN-capable.
- ▶ Routers are not able to send and receive packets with VLAN tags through port-based router interfaces.

#### 10.4.4 IP ToS (Type of Service)

The Type-of-Service field (ToS) in the IP header was already part of the IP protocol from the start, and is used to differentiate different services in IP networks. Even back then, there were ideas about differentiated treatment of IP packets, due to the limited bandwidth available and the unreliable connection paths. Because of the continuous increase in the available bandwidth, there was no need to use the ToS field.

Only with the real-time requirements of today's networks has the ToS field become significant again. Selecting the ToS byte of the IP header enables you to differentiate between different services. However, this field is not widely used in practice.



Table 19: ToS field in the IP header

Bits (0-2): IP Precedence Defined	Bits (3-6): Type of Service Defined	Bit (7)
111 - Network Control	0000 - [all normal]	0 - Zero
110 - Internetwork Control	1000 - [minimize delay]	
101 - CRITIC / ECP	0100 - [maximize throughput]	

Table 19: ToS field in the IP header (cont.)

Bits (0-2): IP Precedence Defined	Bits (3-6): Type of Service Defined	Bit (7)
100 - Flash Override	0010 - [maximize reliability]	
011 - Flash	0001 - [minimize monetary cost]	
010 - Immediate		
001 - Priority		
000 - Routine		

### 10.4.5 Handling of traffic classes

The device provides the following options for handling traffic classes:

- ▶ Strict Priority
- ▶ Weighted Fair Queuing
- ▶ Strict Priority combined with Weighted Fair Queuing
- ▶ Queue management

#### Strict Priority description

With the Strict Priority setting, the device first transmits data packets that have a higher traffic class (higher priority) before transmitting a data packet with the next highest traffic class. When there are no other data packets remaining in the queue, the device transmits a data packet with the lowest traffic class (lowest priority). In unfortunate cases, if there is a high volume of high-priority traffic waiting to be sent on this port, then the device does not send packets with a low priority.

In delay-sensitive applications, such as VoIP or video, Strict Priority lets data to be sent immediately.

#### Weighted Fair Queuing description

With Weighted Fair Queuing, also called Weighted Round Robin (WRR), you assign a minimum or reserved bandwidth to each traffic class. This helps ensure that data packets with a lower priority are also sent although the network is very busy.

The reserved values range from 0% through 100% of the available bandwidth, in steps of 1%.

- ▶ A reservation of 0 is equivalent to a "no bandwidth" setting.
- ▶ The sum of the individual bandwidths can be up to 100%.

When you assign Weighted Fair Queuing to every traffic class, the entire bandwidth of the corresponding port is available to you.

#### Combining Strict Priority and Weighted Fair Queuing

When combining Weighted Fair Queuing with Strict Priority, verify that the highest traffic class of Weighted Fair Queuing is lower than the lowest traffic class of Strict Priority.

If you combine Weighted Fair Queuing with Strict Priority, then a high Strict Priority network load can significantly reduce the bandwidth available for Weighted Fair Queuing.

## 10.4.6 Queue management

### Queue Shaping

Queue Shaping throttles the rate at which queues transmit packets. For example, using Queue Shaping, you rate-limit a higher strict-priority queue so that it lets a lower strict-priority queue to send packets even though higher priority packets are still available for transmission. The device lets you setup Queue Shaping for any queue. You specify Queue Shaping as the maximum rate at which traffic passes through a queue by assigning a percentage of the available bandwidth.

### Defining settings for queue management

Perform the following steps:

- Open the *Switching > QoS/Priority > Queue Management* dialog.  
The total assigned bandwidth in the *Min. bandwidth [%]* column is 100%.
- To activate Weighted Fair Queuing for *Traffic class* = 0, proceed as follows:
  - ▶ Unmark the checkbox in the *Strict priority* column.
  - ▶ In the *Min. bandwidth [%]* column, specify the value 5.
- To activate Weighted Fair Queuing for *Traffic class* = 1, proceed as follows:
  - ▶ Unmark the checkbox in the *Strict priority* column.
  - ▶ In the *Min. bandwidth [%]* column, specify the value 20.
- To activate Weighted Fair Queuing for *Traffic class* = 2, proceed as follows:
  - ▶ Unmark the checkbox in the *Strict priority* column.
  - ▶ In the *Min. bandwidth [%]* column, specify the value 30.
- To activate Weighted Fair Queuing for *Traffic class* = 3, proceed as follows:
  - ▶ Unmark the checkbox in the *Strict priority* column.
  - ▶ In the *Min. bandwidth [%]* column, specify the value 20.
- To activate Weighted Fair Queuing and Queue Shaping for *Traffic class* = 4, proceed as follows:
  - ▶ Unmark the checkbox in the *Strict priority* column.
  - ▶ In the *Min. bandwidth [%]* column, specify the value 10.
  - ▶ In the *Max. bandwidth [%]* column, specify the value 10.

When using a Weighted Fair Queuing and Queue Shaping combination for a specific traffic class, specify a higher value in the *Max. bandwidth [%]* column than the value specified in the *Min. bandwidth [%]* column.
- To activate Weighted Fair Queuing for *Traffic class* = 5, proceed as follows:
  - ▶ Unmark the checkbox in the *Strict priority* column.
  - ▶ In the *Min. bandwidth [%]* column, specify the value 5.
- To activate Weighted Fair Queuing for *Traffic class* = 6, proceed as follows:
  - ▶ Unmark the checkbox in the *Strict priority* column.
  - ▶ In the *Min. bandwidth [%]* column, specify the value 10.
- To activate Strict Priority and Queue Shaping for *Traffic class* = 7, proceed as follows:
  - ▶ Mark the checkbox in the *Strict priority* column.
  - ▶ In the *Max. bandwidth [%]* column, specify the value 10.
- Save the changes temporarily. To do this, click the  button.

```

enable
configure
cos-queue weighted 0
cos-queue min-bandwidth: 0 5
cos-queue weighted 1
cos-queue min-bandwidth: 1 20
cos-queue weighted 2
cos-queue min-bandwidth: 2 30
cos-queue weighted 3
cos-queue min-bandwidth: 3 20

show cos-queue
Queue Id  Min. bandwidth  Max. bandwidth  Scheduler type
-----  -
0         5                0                weighted
1         20               0                weighted
2         30               0                weighted
3         20               0                weighted
4         0                0                strict
5         0                0                strict
6         0                0                strict
7         0                0                strict

```

Change to the Privileged EXEC mode.  
Change to the Configuration mode.  
Enabling Weighted Fair Queuing for traffic class 0.  
Assigning a weight of 5 % to traffic class 0.  
Enabling Weighted Fair Queuing for traffic class 1.  
Assigning a weight of 20 % to traffic class 1.  
Enabling Weighted Fair Queuing for traffic class 2.  
Assigning a weight of 30 % to traffic class 2.  
Enabling Weighted Fair Queuing for traffic class 3.  
Assigning a weight of 20 % to traffic class 3.

### Combining Weighted Fair Queuing and Queue Shaping

Perform the following steps:

```

enable
configure
cos-queue weighted 4
cos-queue min-bandwidth: 4 10
cos-queue max-bandwidth: 4 10
cos-queue weighted 5
cos-queue min-bandwidth: 5 5
cos-queue weighted 6
cos-queue min-bandwidth: 6 10

show cos-queue
Queue Id  Min. bandwidth  Scheduler type
-----  -
0         5                0                weighted
1         20               0                weighted
2         30               0                weighted
3         20               0                weighted
4         10               10               weighted
5         5                0                weighted
6         10               0                weighted
7         0                0                strict

```

Change to the Privileged EXEC mode.  
Change to the Configuration mode.  
Enabling Weighted Fair Queuing for traffic class 4.  
Assigning a weight of 10 % to traffic class 4.  
Assigning a weight of 10 % to traffic class 4.  
Enabling Weighted Fair Queuing for traffic class 5.  
Assigning a weight of 5 % to traffic class 5.  
Enabling Weighted Fair Queuing for traffic class 6.  
Assigning a weight of 10 % to traffic class 6.



### Setting up Queue Shaping

Perform the following steps:

<pre>enable configure cos-queue max-bandwidth: 7 10 show cos-queue Queue Id  Min. bandwidth  Scheduler type -----  -</pre>	<p>Change to the Privileged EXEC mode.</p> <p>Change to the Configuration mode.</p> <p>Assigning a weight of 10 % to traffic class 7.</p>
--	---

Queue Id	Min. bandwidth	Scheduler type	
-----	-----	-----	-----
0	5	0	weighted
1	20	0	weighted
2	30	0	weighted
3	20	0	weighted
4	10	10	weighted
5	5	0	weighted
6	10	0	weighted
7	0	10	strict

### 10.4.7 Management prioritization

In order for you to constantly have access to the device management, although there is a high network load, the device lets you prioritize management packets.

When prioritizing management packets, the device sends the management packets with priority information.

- ▶ On Layer 2, the device modifies the VLAN priority in the VLAN tag.  
The prerequisite for this function is that the corresponding ports are set to allow sending packets with a VLAN tag.
- ▶ On Layer 3, the device modifies the IP-DSCP value.

### 10.4.8 Setting prioritization

#### Assigning the port priority

Perform the following steps:

- Open the [Switching > QoS/Priority > Port Configuration](#) dialog.
- In the [Port priority](#) column, you specify the priority with which the device forwards the data packets received on this port without a VLAN tag.
- In the [Trust mode](#) column, you specify the criteria the device uses to assign a traffic class to data packets received.
- Save the changes temporarily. To do this, click the  button.

```
enable
configure
interface 1/1

vlan priority 3
exit
```

Change to the Privileged EXEC mode.  
Change to the Configuration mode.  
Change to the interface configuration mode of interface [1/1](#).  
Assign interface [1/1](#) the port priority [3](#).  
Change to the Configuration mode.

## Assigning VLAN priority to a traffic class

Perform the following steps:

- Open the [Switching > QoS/Priority > 802.1D/p Mapping](#) dialog.
- To assign a traffic class to a VLAN priority, insert the associated value in the [Traffic class](#) column.
- Save the changes temporarily. To do this, click the  button.

```
enable
configure
classofservice dot1p-mapping 0 2
classofservice dot1p-mapping 1 2
exit
show classofservice dot1p-mapping
```

Change to the Privileged EXEC mode.  
Change to the Configuration mode.  
Assigning a VLAN priority of [0](#) to traffic class [2](#).  
Assigning a VLAN priority of [1](#) to traffic class [2](#).  
Change to the Privileged EXEC mode.  
Display the assignment.

## Assign port priority to received data packets

Perform the following steps:

```
enable
configure
interface 1/1

classofservice trust untrusted
classofservice dot1p-mapping 0 2
classofservice dot1p-mapping 1 2
vlan priority 1
exit
```

Change to the Privileged EXEC mode.  
Change to the Configuration mode.  
Change to the interface configuration mode of interface [1/1](#).  
Assigning the [untrusted](#) mode to the interface.  
Assigning a VLAN priority of [0](#) to traffic class [2](#).  
Assigning a VLAN priority of [1](#) to traffic class [2](#).  
Specifying the value [1](#) for the port priority.  
Change to the Configuration mode.

```
exit
show classofservice trust

Interface Trust Mode
-----
1/1      untrusted
1/2      dot1p
1/3      dot1p
1/4      dot1p
1/5      dot1p
1/6      dot1p
1/7      dot1p
```

Change to the Privileged EXEC mode.  
Displaying the Trust mode of the ports/interfaces.

### Assigning DSCP to a traffic class

Perform the following steps:

- Open the [Switching > QoS/Priority > IP DSCP Mapping](#) dialog.
- Specify the desired value in the [Traffic class](#) column.
- Save the changes temporarily. To do this, click the  button.

```
enable
configure
classofservice ip-dscp-mapping cs1 1
show classofservice ip-dscp-mapping

      IP DSCP      Traffic Class
-----
be          2
1           2
.           .
.           .
(cs1)      1
.           .
```

Change to the Privileged EXEC mode.  
Change to the Configuration mode.  
Assigning the DSCP value `CS1` to traffic class `1`.  
Displaying the IP DSCP assignments

### Assign the DSCP priority to received IP data packets

Perform the following steps:

```
enable
configure
interface 1/1

classofservice trust ip-dscp
```

Change to the Privileged EXEC mode.  
Change to the Configuration mode.  
Change to the interface configuration mode of interface `1/1`.  
Assigning the `trust ip-dscp` mode globally.

```

exit
show classofservice trust

Interface      Trust Mode
-----
1/1            ip-dscp
1/2            dot1p
1/3            dot1p
.              .
.              .
1/5            dot1p
.              .

```

Change to the Configuration mode.  
Displaying the Trust mode of the ports/interfaces.

### Configuring traffic shaping on a port

Perform the following steps:

```

enable
configure
interface 1/2

traffic-shape bw 50

exit
exit
show traffic-shape

Interface  Shaping rate
-----
1/1        0 %
1/2        50 %
1/3        0 %
1/4        0 %

```

Change to the Privileged EXEC mode.  
Change to the Configuration mode.  
Change to the interface configuration mode of interface [1/2](#).  
Limiting the maximum bandwidth of the port [1/2](#) to 50%.  
Change to the Configuration mode.  
Change to the Privileged EXEC mode.  
Display the Traffic Shaping configuration.

### Configuring Layer 2 management priority

Perform the following steps:

- Open the [Switching > QoS/Priority > Global](#) dialog.
- In the [VLAN priority for management packets](#) field, specify the VLAN priority with which the device sends management data packets.
- Save the changes temporarily. To do this, click the  button.

```
enable
```

Change to the Privileged EXEC mode.

```
network management priority dot1p 7
```

Assigning the VLAN priority of 7 to management packets. The device sends management packets with the highest priority.

```
show network parms
```

Displaying the priority of the VLAN in which the device management is located.

```
IPv4 Network  
-----  
...  
Management VLAN priority.....7  
...
```

### Configuring Layer 3 management priority

Perform the following steps:

- Open the *Switching > QoS/Priority > Global* dialog.
- In the *IP DSCP value for management packets* field, specify the DSCP value with which the device sends management data packets.
- Save the changes temporarily. To do this, click the  button.

```
enable
```

Change to the Privileged EXEC mode.

```
network management priority ip-dscp 56
```

Assigning the DSCP value of 56 to management packets. The device sends management packets with the highest priority.

```
show network parms
```

Displaying the priority of the VLAN in which the device management is located.

```
IPv4 Network  
-----  
...  
Management IP-DSCP value.....56
```

## 10.5 Flow control

If a large number of data packets are received in the priority queue of a port at the same time, then this can cause the port memory to overflow. This happens, for example, when the device receives data on a Gigabit port and forwards it to a port with a lower bandwidth. The device discards surplus data packets.

The flow control mechanism described in standard IEEE 802.3 helps ensure that no data packets are lost due to a port memory overflowing. Shortly before a port memory is completely full, the device signals to the connected devices that it is not accepting any more data packets from them.

- ▶ In full-duplex mode, the device sends a pause data packet.
- ▶ In half-duplex mode, the device simulates a collision.

The following figure displays how flow control works. Workstations 1, 2, and 3 want to simultaneously transmit a large amount of data to Workstation 4. The combined bandwidth of Workstations 1, 2, and 3 is greater than the bandwidth of Workstation 4. This causes an overflow on the receive queue of port 4. The left funnel symbolizes this status.

When the flow control function on ports 1, 2 and 3 of the device is enabled, the device reacts before the funnel overflows. The funnel on the right illustrates ports 1, 2 and 3 sending a message to the transmitting devices to control the transmission speed. This results in the receiving port no longer being overwhelmed and is able to process the incoming traffic.

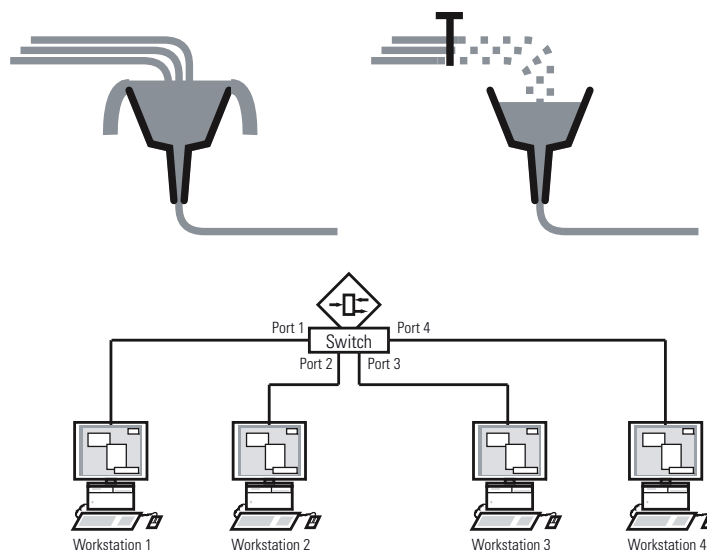

Figure 24: Example of flow control

### 10.5.1 Halfduplex or fullduplex link

#### Flow Control with a half duplex link

In the example, there is a halfduplex link between Workstation 2 and the device.

Before the send queue of port 2 overflows, the device sends data back to Workstation 2. Workstation 2 detects a collision and stops transmitting.

### Flow Control with a full duplex link

In the example, there is a full duplex link between Workstation 2 and the device.

Before the send queue of port 2 overflows, the device sends a request to Workstation 2 to include a small break in the sending transmission.

## 10.5.2 Setting up the Flow Control

Perform the following steps:

- Open the *Switching > Global* dialog.
- Mark the *Flow control* checkbox.  
With this setting you enable flow control in the device.
- Open the *Basic Settings > Port* dialog, *Configuration* tab.
- To enable the Flow Control on a port, mark the checkbox in the *Flow control* column.
- Save the changes temporarily. To do this, click the  button.

**Note:** When you are using a redundancy function, you deactivate the flow control on the participating ports. If the flow control and the redundancy function are active at the same time, it is possible that the redundancy function operates differently than intended.

# 11 Planning data streams for TSN

## 11.1 Explanation of terms

The following figure gives the definition of the term Service Data Unit (SDU) and related quantities.

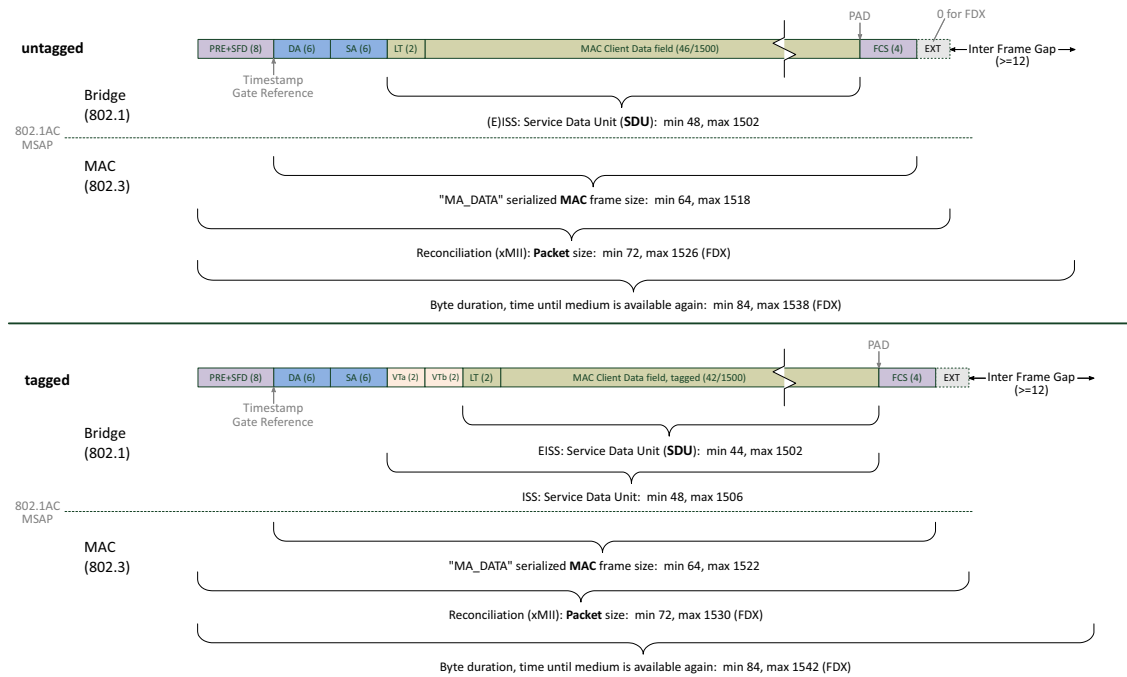



## 11.2 Underlying facts

When you use the *TSN* function, the following basic conditions apply:

- ▶ The device operates using the "Store and Forward" method. Thus, the device has to receive the complete data packet before it makes a forwarding decision.
- ▶ When configuring the Gate Control List, the configurator needs to know the forwarding delays that the TSN data stream will encounter at each device on the network path. This delay consists of the sum of each preceding Propagation delay and Bridge delay for a given device.
- ▶ The Bridge delay depends on properties of the ingress and egress ports, for example, the port speeds. As these properties can be different per port, the Bridge delay is further divided into Reception delay and Transmission delay in this chapter.
- ▶ The Reception delay and Transmission delay consist of a delay that is independent of packet length, plus a delay that is dependent on packet length. The external reference plane for these delays is the boundary between the network media and PHY as specified by IEEE 802.1AS.
- ▶ When you provide each delay, the related data packet is not subject to any further delay between reception delay and transmission delay, for example, caused by cross-traffic.
- ▶ We recommended you use the ports 1/1 and 1/2. When you use every TSN-capable port, connect end devices to port 1/3. Compared to the ports 1/1 and 1/2, port 1/3 has an additional packet length-dependent delay after the gate open operation, due to the device architecture.
- ▶ Given the above conditions, the observable gate open operation aligns with the egress of the data packet from the twisted pair/optical port. On port 1/3, the additional packet length-dependent part of the Transmission delay is added.

## 11.3 Propagation delay

When you specify the time slots in the Gate Control List, also take into account a Propagation delay (according to IEEE 802.1Qcc, clause 12.32.2). The Propagation delay of a data packet between 2 devices depends on the line length (approx. 5 ns/m). This delay is also measured by the *PTP* function (IEEE 1588) and can be read back from the device as 'Peer delay'.

## 11.4 Bridge delay

The Bridge delay is the interval between the moment the RX port receives the start of a data packet and the moment the TX port transmits the start of this data packet.

To calculate the delay use the following tables. **Bridge delay = Reception delay + Transmission delay**

The Reception delay and Transmission delay consist of:

- ▶ A packet length-independent delay (according to IEEE 802.1Qcc, clause 12.32.1.1), depending on:
  - Port speed
  - Number of the port which receives the data packet
  - Number of the port which transmits the data packet
  - Medium
  - Jitter
- ▶ A packet length-dependent delay (according to IEEE 802.1Qcc, clause 12.32.1.2):  
You calculate the Dependent delay using the formula given in the following tables.

### 11.4.1 Reception delay

Port speed	RX port	Medium	Independent delay [ns]	Dependent delay [ns] <sup>1</sup>	Max. Reception delay [ns]	
					68 octets data packet (incl. 4 octets VLAN tag) <sup>2</sup>	1522 octets data packet 48 octets SDU <sup>3</sup> 1502 octets SDU <sup>3</sup>
100 Mbit/s	1/1 1/2	Twisted pair	3920 ... 3940	80 × SDU	7780	124100
		Optical	3830 ... 3840	80 × SDU	7680	124000
	1/3	Twisted pair	11480 ... 11690	160 × SDU	19370	252010
		Optical	11380 ... 11600	160 × SDU	19280	251920
1 Gbit/s	1/1 1/2	Twisted pair	1064 ... 1094	8 × SDU	1478	13110
		Optical	924 ... 954	8 × SDU	1338	12970
	1/3	Twisted pair	3388 ... 3538	16 × SDU	4306	27570
		Optical	3238 ... 3388	16 × SDU	4156	27420

1. For the SDU length, refer to section “Explanation of terms” on page 141.

2. These octets are included in the Independent delay, together with PREAMBLE, MAC addresses and FCS.

3. The VLAN tag is not part of the SDU.

## 11.4.2 Transmission delay

Port speed	TX port	Medium	Independent delay [ns]	Dependent delay [ns] <sup>1</sup>	Max. Transmission delay [ns]	
					68 octets data packet (incl. 4 octets VLAN tag) <sup>2</sup>	1522 octets data packet
					48 octets SDU <sup>3</sup>	1502 octets SDU <sup>3</sup>
100 Mbit/s	1/1 1/2	Twisted pair	1660 ... 1690	0	1690	1690
		Optical	1720 ... 1750	0	1750	1750
	1/3	Twisted pair	9670 ... 9900	80 × SDU	13740	130060
		Optical	9730 ... 9960	80 × SDU	13800	130120
1 Gbit/s	1/1 1/2	Twisted pair	530 ... 550	0	550	550
		Optical	510 ... 530	0	530	530
	1/3	Twisted pair	2904 ... 3124	8 × SDU	3508	15140
		Optical	2884 ... 3104	8 × SDU	3488	15120

1. Necessary to calculate the gate open time in the next device. For the SDU length, refer to section ["Explanation of terms" on page 141](#).
2. These octets are included in the Independent delay, together with PREAMBLE, MAC addresses and FCS.
3. The VLAN tag is not part of the SDU.

## 11.5 Example

For the following network, we calculate the gate open times for one data packet. In this example we use the maximum delay values.

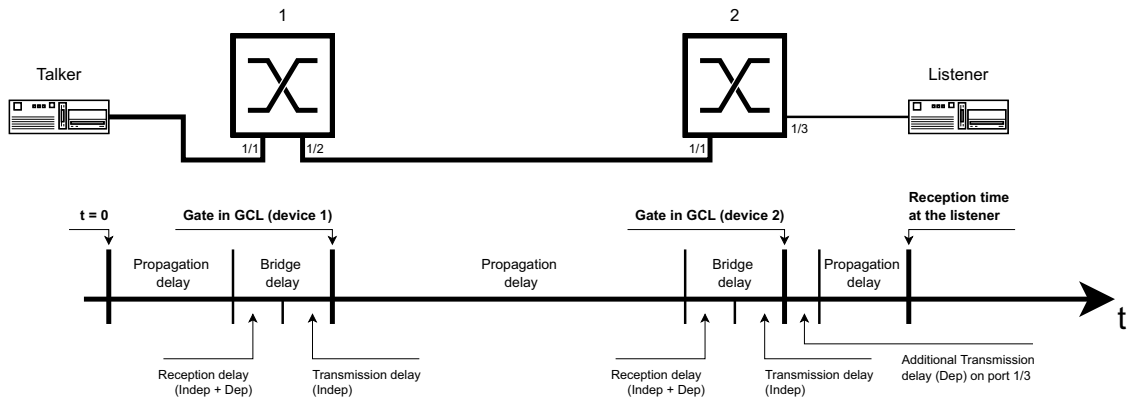

### 11.5.1 Time calculation

#### Talker

- ▶ The Talker sends a data packet with a 300 octets long SDU in the cycle at time  $t = 0$ .  
12 octets MAC + 4 octets VLAN + 300 octets SDU + 4 octets FCS = 320 octets long Ethernet packet

#### Device 1

- ▶ Device 1 receives the data packet on twisted pair port 1/1 with 1 Gbit/s.
- ▶ The line length between Talker and Device 1 is 10 m.
- ▶ Device 1 transmits the data packet on optical port 1/2 with 1 Gbit/s.

<b>Propagation delay</b>		$10 \text{ m} \times 5 \text{ ns/m}$	<b>50 ns</b>
<b>Bridge delay (Device 1)</b>	Reception delay	Independent delay	1094 ns
		Dependent delay	$8 \text{ ns/oct.} \times 300 \text{ oct.}$
			<b>2400 ns</b>
	Transmission delay	Independent delay	530 ns
		$1094 \text{ ns} + 2400 \text{ ns} + 530 \text{ ns}$	<b>4024 ns</b>
<b>Gate open time (Device 1)</b>	Propagation delay	50 ns	
	Bridge delay (Device 1)	4024 ns	
			<b><math>\approx 4100 \text{ ns}</math></b>

<b>Minimal gate open interval for one data packet</b> (Device 1, ports 1/1, 1/2)	The gate needs to be open at least long enough for a data packet incl. PREABMLE, MAC, VLAN, SDU, FCS and IFG (SDU + 40 octets) to pass with the maximum possible delay. Multiply the number of octets with a factor depending on the TX port speed (80 for 100 Mbit/s, 8 for 1 Gbit/s).	8 ns/oct. × 340 oct.	2720 ns
	Especially when scheduling gates intended to pass a single packet, consider some internal overhead. The value given is the overhead for 1 Gbit/s.		180 ns
	PTP accuracy margin	1 μs	1000 ns
			<b>≈ 3900 ns</b>

**Device 2**

- ▶ Device 2 receives the data packet on optical port 1/1 with 1 Gbit/s.
- ▶ The line length between Device 1 and Device 2 is 50 m.
- ▶ Device 2 transmits the data packet on twisted pair port 1/3 with 100 Mbit/s.

<b>Gate open time</b> (Device 1)			<b>4100 ns</b>
<b>Transmission delay</b> (Device 1 port 1/2)		Dependent delay	<b>0 ns</b>
<b>Propagation delay</b>		50 m × 5 ns/m	<b>250 ns</b>
<b>Bridge delay</b> (Device 2)	Reception delay	Independent delay	954 ns
		Dependent delay	2400 ns
	Transmission delay	Independent delay	9900 ns
		954 ns + 2400 ns + 9900 ns	<b>13254 ns</b>

<b>Gate open time</b> (Device 2)	Gate open time (Device 1)		4100 ns
	Transmission delay (Device 1 port 1/2)		0 ns
	Propagation delay		250 ns
	Bridge delay (Device 2)		13254 ns
			<b>≈ 17650 ns</b>
<b>Minimal gate open interval for one data packet</b> (Device 2, ports 1/3)	The gate needs to be open at least long enough for a data packet incl. PREABMLE, MAC, VLAN, SDU, FCS and IFG (SDU + 40 octets) to pass with the maximum possible delay. Multiply the number of octets with a factor depending on the TX port speed (80 for 100 Mbit/s, 8 for 1 Gbit/s).	80 ns/oct. × 340 oct.	27200 ns
	Especially when scheduling gates intended to pass a single packet, consider some internal overhead. The value given is the overhead for 100 Mbit/s.		1400 ns
	PTP accuracy margin	1 μs	1000 ns
			<b>≈ 29600 ns</b>

**Listener**

- ▶ The Listener receives the data packet on twisted pair port 1/3 with 100 Mbit/s.
- ▶ The line length between Device 2 and Listener is 10 m.

<b>Gate open time</b> (Device 2)			<b>17650 ns</b>
<b>Transmission delay</b> (Device 2 port 1/3)	Dependent delay	80 ns/oct. × 300 oct.	<b>24000 ns</b>

<b>Propagation delay</b>		$10\text{ m} \times 5\text{ ns/m}$	<b>50 ns</b>
<b>Reception time</b>	Gate open time (Device 2)		17650 ns
	Transmission delay (Device 2 port 1/3)		24000 ns
	Propagation delay		50 ns
	PTP accuracy margin	1 $\mu\text{s}$	1000 ns
			<b><math>\approx 42700\text{ ns}</math></b>

### 11.5.2 Set up the devices

Using the previously calculated times, you set up the devices using the Graphical User Interface or the Command Line Interface.

Perform the following steps:

- Check the Cycle time.
- Open the *Switching > TSN > Configuration* dialog.
- Check the value in the *Cycle time [ns] > Configured* column.

Operation						
<input checked="" type="radio"/> On <input type="radio"/> Off						
<input type="checkbox"/>	Port	Active	Default gate states	Port state	Cycle time [ns]	
					Configured	Current
<input type="checkbox"/>	1/1	<input checked="" type="checkbox"/>	0,1,2,3,4,5,6,7	running	1,000,000	1,000,000
<input type="checkbox"/>	1/2	<input checked="" type="checkbox"/>	0,1,2,3,4,5,6,7	running	1,000,000	1,000,000
<input type="checkbox"/>	1/3	<input type="checkbox"/>	0,1,2,3,4,5,6,7	disabled	1,000,000	0



```
enable
configure
show tsn configuration
Port  Status                Conf. cycle time[ns]  Conf. base time
      Default gate states  Curr. cycle time[ns]  Curr. base time
      Config change pending  Time of last activation
-----
1/1   [x]                running              1000000  1970-01-01 00:00:00.000000000
      7,6,5,4,3,2,1,0    1000000  1970-01-01 00:00:00.000000000
      [ ]                2018-07-12 08:10:58.813000000

1/2   [x]                running              1000000  1970-01-01 00:00:00.000000000
      7,6,5,4,3,2,1,0    1000000  1970-01-01 00:00:00.000000000
      [ ]                2018-07-11 07:24:35.204000000

1/3   [ ]                disabled             1000000  1970-01-01 00:00:00.000000000
      7,6,5,4,3,2,1,0    0        1970-01-01 00:00:00.000000000
      [ ]                1970-01-01 00:00:00.000000000
```

Change to the Privileged EXEC mode.  
Change to the Configuration mode.

- Set up the Gate Control List for Device 1.

- Open the *Switching > TSN > Gate Control List* dialog.
- Select the tab for port *1/2*.

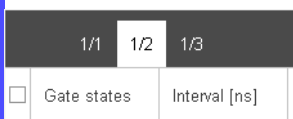

```
enable
configure
interface 1/2
```

Change to the Privileged EXEC mode.  
Change to the Configuration mode.  
Change to the interface configuration mode of interface *1/2*.

- Make a table entry which covers each traffic class.
- In the *Interval [ns]* column, enter the **Gate open time** (Device 1) value.

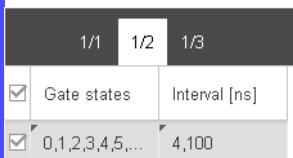

- Save the changes temporarily. To do this, click the  button.

```
tsn gcl add id 1 gate-states 0,1,2,3,4,5,6,7 interval 4100
```

- Make a table entry which covers traffic class 5.
- In the *Interval [ns]* column, enter the **Minimal gate open interval for one data packet** (Device 1, ports 1/1, 1/2) value.

		1/1	1/2	1/3
<input type="checkbox"/>	Gate states	Interval [ns]		
<input type="checkbox"/>	0,1,2,3,4,5,6,7	4,100		
<input checked="" type="checkbox"/>	5	3,900		

- Save the changes temporarily. To do this, click the  button.

```
tsn gcl add id 2 gate-states 5 interval 3900
```

- Make a table entry which fills the remaining Cycle time.

		1/1	1/2	1/3
<input type="checkbox"/>	Gate states	Interval [ns]		
<input type="checkbox"/>	0,1,2,3,4,5,6,7	4,100		
<input type="checkbox"/>	5	3,900		
<input checked="" type="checkbox"/>	0,1,2,3,4,5,6,7	992,000		

- Save the changes temporarily. To do this, click the  button.

```
tsn gcl add id 3 gate-states 0,1,2,3,4,5,6,7 interval 992000
tsn commit
```

Commit the configured values to be active as current values.

- Set up the Gate Control List for Device 2.

- Open the *Switching > TSN > Gate Control List* dialog.
- Select the tab for port 1/3.

		1/1	1/2	1/3
<input type="checkbox"/>	Gate states	Interval [ns]		

```
enable
configure
interface 1/3
```

Change to the Privileged EXEC mode.  
Change to the Configuration mode.  
Change to the interface configuration mode of interface 1/3.

- Make a table entry which covers each traffic class.
- In the *Interval [ns]* column, enter the **Gate open time** (Device 2) value.

	1/1	1/2	1/3
<input checked="" type="checkbox"/> Gate states			Interval [ns]
<input checked="" type="checkbox"/> 0,1,2,3,4,5,6,7			17,650

- Save the changes temporarily. To do this, click the  button.

```
tsn gcl add id 1 gate-states 0,1,2,3,4,5,6,7 interval 17650
```

- Make a table entry which covers traffic class 5.
- In the *Interval [ns]* column, enter the **Minimal gate open interval for one data packet** (Device 2, ports 1/3) value.

	1/1	1/2	1/3
<input type="checkbox"/> Gate states			Interval [ns]
<input type="checkbox"/> 0,1,2,3,4,5,6,7			17,650
<input checked="" type="checkbox"/> 5			29,600

- Save the changes temporarily. To do this, click the  button.

```
tsn gcl add id 2 gate-states 5 interval 29600
```

- Make a table entry which fills the remaining Cycle time.

	1/1	1/2	1/3
<input type="checkbox"/> Gate states			Interval [ns]
<input type="checkbox"/> 0,1,2,3,4,5,6,7			17,650
<input type="checkbox"/> 5			29,600
<input checked="" type="checkbox"/> 0,1,2,3,4,5,6,7			952,750

- Save the changes temporarily. To do this, click the  button.

```
tsn gcl add id 3 gate-states 0,1,2,3,4,5,6,7 interval 952750
tsn commit
```

Commit the configured values to be active as current values.

## 12 VLANs

In the simplest case, a virtual LAN (VLAN) consists of a group of network participants in one network segment who can communicate with each other as though they belonged to a separate LAN.

More complex VLANs span out over multiple network segments and are also based on logical (instead of only physical) connections between network participants. VLANs are an element of flexible network design. It is easier to reconfiguring logical connections centrally than cable connections.

The device supports independent VLAN learning in accordance with the IEEE 802.1Q standard which defines the [VLAN](#) function.

Using VLANs has many benefits. The following list displays the top benefits:

- ▶ Network load limiting  
VLANs reduce the network load considerably as the devices transmit Broadcast, Multicast, and Unicast packets with unknown (unlearned) destination addresses only inside the virtual LAN. The rest of the data network forwards traffic as normal.
- ▶ Flexibility  
You have the option of forming user groups based on the function of the participants apart from their physical location or medium.
- ▶ Clarity  
VLANs give networks a clear structure and make maintenance easier.

### 12.1 Examples of VLANs

The following practical examples provide a quick introduction to the structure of a VLAN.

**Note:** When configuring VLANs you use an interface for accessing the device management that will remain unchanged. For this example, you use either interface 1/6 or the serial connection to configure the VLANs.

### 12.1.1 Example 1

The example displays a minimal VLAN configuration (port-based VLAN). An administrator has connected multiple end devices to a transmission device and assigned them to 2 VLANs. This effectively prohibits any data transmission between the VLANs, whose members communicate only within their own VLANs.

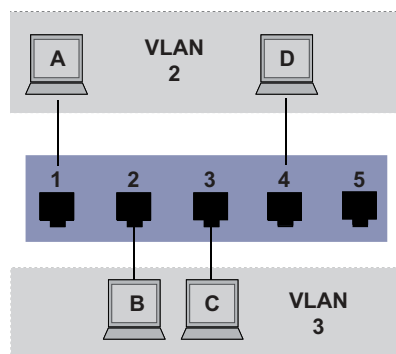

Figure 25: Example of a simple port-based VLAN

When setting up the VLANs, you create communication rules for every port, which you enter in ingress (incoming) and egress (outgoing) tables.

The ingress table specifies which VLAN ID a port assigns to the incoming data packets. Hereby, you use the port address of the end device to assign it to a VLAN.

The egress table specifies on which ports the device sends the packets from this VLAN.

- ▶ T = Tagged (with a tag field, marked)
- ▶ U = Untagged (without a tag field, unmarked)

For this example, the status of the TAG field of the data packets has no relevance, so you use the setting U.

Table 20: Ingress table

Terminal	Port	Port VLAN identifier (PVID)
A	1	2
B	2	3
C	3	3
D	4	2
	5	1

Table 21: Egress table

VLAN ID	Port				
	1	2	3	4	5
1					U
2	U			U	
3		U	U		

Perform the following steps:

Setting up the VLAN

- Open the *Switching > VLAN > Configuration* dialog.
- Click the  button.  
The dialog displays the *Create* window.
- In the *VLAN ID* field, specify the value *2*.
- Click the *Ok* button.
- For the VLAN, specify the name *VLAN2*:  
Double-click in the *Name* column and specify the name.  
For VLAN *1*, in the *Name* column, change the value *Default* to *VLAN1*.
- Repeat the previous steps to create a VLAN *3* with the name *VLAN3*.

```
enable
vlan database
vlan add 2
name 2 VLAN2
vlan add 3
name 3 VLAN3
name 1 VLAN1
exit
show vlan brief
```

Change to the Privileged EXEC mode.  
Change to the VLAN configuration mode.  
Creates a new VLAN with the VLAN ID *2*.  
Assign the name *2* to the VLAN *VLAN2*.  
Creates a new VLAN with the VLAN ID *3*.  
Assign the name *3* to the VLAN *VLAN3*.  
Assign the name *1* to the VLAN *VLAN1*.  
Change to the Privileged EXEC mode.  
Display the current VLAN configuration.

Max. VLAN ID.....	4042		
Max. supported VLANs.....	256		
Number of currently configured VLANs.....	3		
vlan unaware mode.....	disabled		
VLAN ID	VLAN Name	VLAN Type	VLAN Creation Time
1	VLAN1	default	0 days, 00:00:05
2	VLAN2	static	0 days, 02:44:29
3	VLAN3	static	0 days, 02:52:26

Setting up the ports

- Open the *Switching > VLAN > Port* dialog.
- To assign the port to a VLAN, specify the desired value in the corresponding column.  
Possible values:
  - ▶ *T* = The port is a member of the VLAN. The port transmits tagged data packets.
  - ▶ *U* = The port is a member of the VLAN. The port transmits untagged data packets.
  - ▶ *F* = The port is not a member of the VLAN.
  - ▶ *-* = The port is not a member of this VLAN.
 Because end devices usually interpret untagged data packets, you specify the value *U*.
- Save the changes temporarily. To do this, click the  button.
- Open the *Switching > VLAN > Port* dialog.
- In the *Port-VLAN ID* column, specify the VLAN ID of the related VLAN:  
*2* or *3*

- Because end devices usually interpret untagged data packets, in the *Acceptable packet types* column, you specify the value `admitAll` for end device ports.
- Save the changes temporarily. To do this, click the  button.

The value in the *Ingress filtering* column has no affect on how this example functions.

<pre>enable configure interface 1/1  vlan participation include 2  vlan pvid 2 exit interface 1/2  vlan participation include 3  vlan pvid 3 exit interface 1/3  vlan participation include 3  vlan pvid 3 exit interface 1/4  vlan participation include 2  vlan pvid 2 exit exit show vlan id 3</pre>	<p>Change to the Privileged EXEC mode.</p> <p>Change to the Configuration mode.</p> <p>Change to the interface configuration mode of interface 1/1.</p> <p>The port 1/1 becomes a member of the VLAN 2 and transmits the data packets without a VLAN tag.</p> <p>Assign the port VLAN ID 1/1 to port 2.</p> <p>Change to the Configuration mode.</p> <p>Change to the interface configuration mode of interface 1/2.</p> <p>The port 1/2 becomes a member of the VLAN 3 and transmits the data packets without a VLAN tag.</p> <p>Assign the port VLAN ID 1/2 to port 3.</p> <p>Change to the Configuration mode.</p> <p>Change to the interface configuration mode of interface 1/3.</p> <p>The port 1/3 becomes a member of the VLAN 3 and transmits the data packets without a VLAN tag.</p> <p>Assign the port VLAN ID 1/3 to port 3.</p> <p>Change to the Configuration mode.</p> <p>Change to the interface configuration mode of interface 1/4.</p> <p>The port 1/4 becomes a member of the VLAN 2 and transmits the data packets without a VLAN tag.</p> <p>Assign the port VLAN ID 1/4 to port 2.</p> <p>Change to the Configuration mode.</p> <p>Change to the Privileged EXEC mode.</p> <p>Displays details for VLAN 3.</p>
---	--

```
VLAN ID          : 3
VLAN Name       : VLAN3
VLAN Type      : Static
Interface  Current  Configured  Tagging
-----  -
1/1          -      Autodetect  Tagged
1/2          Include  Include     Untagged
1/3          Include  Include     Untagged
1/4          -      Autodetect  Tagged
1/5          -      Autodetect  Tagged
```

### 12.1.2 Example 2

The second example displays a more complex configuration with 3 VLANs (1 to 3). Along with the Switch from example 1, you use a 2nd Switch (on the right in the example).

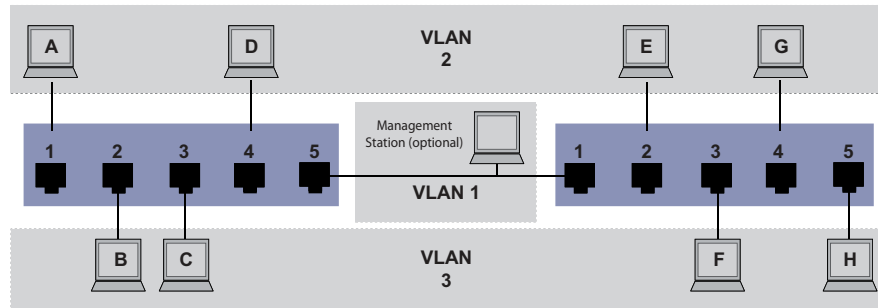

Figure 26: Example of a more complex VLAN configuration

The terminal devices of the individual VLANs (A to H) are spread over 2 transmission devices (Switches). Such VLANs are therefore known as distributed VLANs. If the VLAN is configured correctly, then an optional network management station is also shown, which enables access to every network component.

**Note:** In this case, VLAN 1 has no significance for the end device communication, but it is required for the administration of the transmission devices via what is known as the Management VLAN.

As in the previous example, uniquely assign the ports with their connected terminal devices to a VLAN. With the direct connection between the 2 transmission devices (uplink), the ports transport packets for both VLANs. To differentiate these uplinks you use “VLAN tagging”, which handles the data packets accordingly. Thus, you maintain the assignment to the respective VLANs.

Perform the following steps:

- Add Uplink Port 5 to the ingress and egress tables from example 1.
- Create new ingress and egress tables for the right switch, as described in the first example.

The egress table specifies on which ports the device sends the packets from this VLAN.

- ▶ T = Tagged (with a tag field, marked)
- ▶ U = Untagged (without a tag field, unmarked)

In this example, tagged packets are used in the communication between the transmission devices (Uplink), as packets for different VLANs are differentiated at these ports.

Table 22: Ingress table for device on left

Terminal	Port	Port VLAN identifier (PVID)
A	1	2
B	2	3
C	3	3
D	4	2
Uplink	5	1



Table 23: Ingress table for device on right

Terminal	Port	Port VLAN identifier (PVID)
Uplink	1	1
E	2	2
F	3	3
G	4	2
H	5	3

Table 24: Egress table for device on left

VLAN ID	Port				
	1	2	3	4	5
1					U
2	U			U	T
3		U	U		T

Table 25: Egress table for device on right

VLAN ID	Port				
	1	2	3	4	5
1	U				
2	T	U		U	
3	T		U		U

The communication relationships here are as follows: end devices on ports 1 and 4 of the left device and end devices on ports 2 and 4 of the right device are members of VLAN 2 and can thus communicate with each other. The behavior is the same for the end devices on ports 2 and 3 of the left device and the end devices on ports 3 and 5 of the right device. These belong to VLAN 3.

The end devices “see” their respective part of the network. Participants outside this VLAN cannot be reached. The device also sends Broadcast, Multicast, and Unicast packets with unknown (unlearned) destination addresses only inside a VLAN.

Here, the devices use VLAN tagging (IEEE 801.1Q) within the VLAN with the ID 1 (Uplink). The letter T in the egress table of the ports indicates VLAN tagging.

The configuration of the example is the same for the device on the right. Proceed in the same way, using the ingress and egress tables created above to adapt the previously configured left device to the new environment.

Perform the following steps:

- Setting up the VLAN
- Open the *Switching > VLAN > Configuration* dialog.
- Click the  button.  
The dialog displays the *Create* window.
- In the *VLAN ID* field, specify the VLAN ID, for example 2.

- Click the *Ok* button.
- For the VLAN, specify the name `VLAN2`:  
Double-click in the *Name* column and specify the name.  
For VLAN 1, in the *Name* column, change the value `Default` to `VLAN1`.
- Repeat the previous steps to create a VLAN 3 with the name `VLAN3`.

```
enable
vlan database
vlan add 2
name 2 VLAN2
vlan add 3
name 3 VLAN3
name 1 VLAN1
exit
show vlan brief
```

Change to the Privileged EXEC mode.  
Change to the VLAN configuration mode.  
Creates a new VLAN with the VLAN ID 2.  
Assign the name 2 to the VLAN `VLAN2`.  
Creates a new VLAN with the VLAN ID 3.  
Assign the name 3 to the VLAN `VLAN3`.  
Assign the name 1 to the VLAN `VLAN1`.  
Change to the Privileged EXEC mode.  
Display the current VLAN configuration.

```
Max. VLAN ID..... 4042
Max. supported VLANs..... 256
Number of currently configured VLANs..... 3
vlan unaware mode..... disabled
```

VLAN ID	VLAN Name	VLAN Type	VLAN Creation Time
1	VLAN1	default	0 days, 00:00:05
2	VLAN2	static	0 days, 02:44:29
3	VLAN3	static	0 days, 02:52:26

Setting up the ports

- Open the *Switching > VLAN > Port* dialog.
- To assign the port to a VLAN, specify the desired value in the corresponding column.  
Possible values:
  - ▶ `T` = The port is a member of the VLAN. The port transmits tagged data packets.
  - ▶ `U` = The port is a member of the VLAN. The port transmits untagged data packets.
  - ▶ `F` = The port is not a member of the VLAN.
  - ▶ `-` = The port is not a member of this VLAN.
Because end devices usually interpret untagged data packets, you specify the value `U`.  
You specify the `T` setting on the uplink port on which the VLANs communicate with each other.
- Save the changes temporarily. To do this, click the  button.
- Open the *Switching > VLAN > Port* dialog.
- In the *Port-VLAN ID* column, specify the VLAN ID of the related VLAN:  
`1, 2 or 3`
- Because end devices usually interpret untagged data packets, in the *Acceptable packet types* column, you specify the value `admitAll` for end device ports.
- For the uplink port, in the *Acceptable packet types* column, specify the value `admitOnlyVlanTagged`.
- Mark the checkbox in the *Ingress filtering* column for the uplink ports to evaluate VLAN tags on this port.
- Save the changes temporarily. To do this, click the  button.

```
enable
configure
interface 1/1

vlan participation include 1

vlan participation include 2

vlan tagging 2 enable

vlan participation include 3

vlan tagging 3 enable

vlan pvid 1
vlan ingressfilter
vlan acceptframe vlanonly
exit
interface 1/2

vlan participation include 2

vlan pvid 2
exit
interface 1/3

vlan participation include 3

vlan pvid 3
exit
interface 1/4

vlan participation include 2

vlan pvid 2
exit
interface 1/5

vlan participation include 3

vlan pvid 3
exit
```

Change to the Privileged EXEC mode.

Change to the Configuration mode.

Change to the interface configuration mode of interface 1/1.

The port 1/1 becomes a member of the VLAN 1 and transmits the data packets without a VLAN tag.

The port 1/1 becomes a member of the VLAN 2 and transmits the data packets without a VLAN tag.

The port 1/1 becomes a member of the VLAN 2 and transmits the data packets with a VLAN tag.

The port 1/1 becomes a member of the VLAN 3 and transmits the data packets without a VLAN tag.

The port 1/1 becomes a member of the VLAN 3 and transmits the data packets with a VLAN tag.

Assigning the Port VLAN ID 1 to port 1/1.

Activate ingress filtering on port 1/1.

Port 1/1 only forwards packets with a VLAN tag.

Change to the Configuration mode.

Change to the interface configuration mode of interface 1/2.

The port 1/2 becomes a member of the VLAN 2 and transmits the data packets without a VLAN tag.

Assigning the Port VLAN ID 2 to port 1/2.

Change to the Configuration mode.

Change to the interface configuration mode of interface 1/3.

The port 1/3 becomes a member of the VLAN 3 and transmits the data packets without a VLAN tag.

Assigning the Port VLAN ID 3 to port 1/3.

Change to the Configuration mode.

Change to the interface configuration mode of interface 1/4.

The port 1/4 becomes a member of the VLAN 2 and transmits the data packets without a VLAN tag.

Assigning the Port VLAN ID 2 to port 1/4.

Change to the Configuration mode.

Change to the interface configuration mode of interface 1/5.

The port 1/5 becomes a member of the VLAN 3 and transmits the data packets without a VLAN tag.

Assigning the Port VLAN ID 3 to port 1/5.

Change to the Configuration mode.

```
exit
show vlan id 3
VLAN ID.....3
VLAN Name.....VLAN3
VLAN Type.....Static
VLAN Creation Time.....0 days, 00:07:47 (System Uptime)
VLAN Routing.....disabled
```

Change to the Privileged EXEC mode.

Displays details for VLAN 3.

Interface	Current	Configured	Tagging
-----	-----	-----	-----
1/1	Include	Include	Tagged
1/2	-	Autodetect	Untagged
1/3	Include	Include	Untagged
1/4	-	Autodetect	Untagged
1/5	Include	Include	Untagged

## 12.2 Guest VLAN / Unauthenticated VLAN

A Guest VLAN lets a device provide port-based Network Access Control (IEEE 802.1x) to non-802.1x capable supplicants. This feature provides a mechanism to allow guests to access external networks only. If you connect non-802.1x capable supplicants to an active unauthorized 802.1x port, then the supplicants send no responds to 802.1x requests. Since the supplicants send no responses, the port remains in the unauthorized state. The supplicants have no access to external networks.



The Guest VLAN supplicant is a per-port basis configuration. When you configure a port as a Guest VLAN and connect non-802.1x capable supplicants to this port, the device assigns the supplicants to the Guest VLAN. Adding supplicants to a Guest VLAN causes the port to change to the authorized state allowing the supplicants to access to external networks.

An Unauthenticated VLAN lets the device provide service to 802.1x capable supplicants which authenticate incorrectly. This function lets the unauthorized supplicants have access to limited services. If you configure an Unauthenticated VLAN on a port with 802.1x port authentication and the global operation enabled, then the device places the port in an Unauthenticated VLAN. When a 802.1x capable supplicant incorrectly authenticates on the port, the device adds the supplicant to the Unauthenticated VLAN. If you also configure a Guest VLAN on the port, then non-802.1x capable supplicants use the Guest VLAN.

If the port has an Unauthenticated VLAN assigned, then the reauthentication timer counts down. When the time specified in the *Reauthentication period [s]* column expires and supplicants are present on the port, the Unauthenticated VLAN reauthenticates. When no supplicants are present, the device places the port in the configured Guest VLAN.

The following example explains how to create a Guest VLAN. Create an Unauthorized VLAN in the same manner.

Perform the following steps:

- Open the *Switching > VLAN > Configuration* dialog.
- Click the  button.  
The dialog displays the *Create* window.
- In the *VLAN ID* field, specify the value *10*.
- Click the *Ok* button.
- For the VLAN, specify the name *Guest*:  
Double-click in the *Name* column and specify the name.
- Click the  button.  
The dialog displays the *Create* window.
- In the *VLAN ID* field, specify the value *20*.
- Click the *Ok* button.
- For the VLAN, specify the name *Not authorized*:  
Double-click in the *Name* column and specify the name.
- Open the *Network Security > 802.1X Port Authentication > Global* dialog.
- To enable the function, select the *On* radio button in the *Operation* frame.
- Save the changes temporarily. To do this, click the  button.

- Open the *Network Security > 802.1X Port Authentication > Port Configuration* dialog.
- Specify the following settings for port 1/4:
  - The value `auto` in the *Port control* column
  - The value `10` in the *Guest VLAN ID* column
  - The value `20` in the *Unauthenticated VLAN ID* column
- Save the changes temporarily. To do this, click the  button.

```
enable
vlan database
vlan add 10
vlan add 20
name 10 Guest
name 20 Unauth
exit
configure
dot1x system-auth-control enable

dot1x port-control auto
interface 1/4

dot1x guest-vlan 10
dot1x unauthenticated-vlan 20
exit
```

Change to the Privileged EXEC mode.

Change to the VLAN configuration mode.

Creates VLAN 10.

Creates VLAN 20.

Renames VLAN 10 to `Guest`.

Renames VLAN 20 to `Unauth`.

Change to the Privileged EXEC mode.

Change to the Configuration mode.

Enable the *802.1X Port Authentication* function globally.

Enables port control on port 1/4.

Change to the interface configuration mode of interface 1/4.

Assign the guest vlan to port 1/4.

Assign the unauthorized vlan to port 1/4.

Change to the Configuration mode.

## 12.3 RADIUS VLAN assignment

The RADIUS VLAN assignment feature makes it possible for a RADIUS VLAN ID attribute to be associated with an authenticated client. When a client authenticates successfully, and the RADIUS server sends a VLAN attribute, the device associates the client with the RADIUS assigned VLAN. As a result, the device adds the physical port as an untagged member to the appropriate VLAN and sets the port VLAN ID (PVID) with the given value.

## 12.4 Creating a Voice VLAN

Use the Voice VLAN feature to separate voice and data traffic on a port, by VLAN and/or priority. A primary benefit of using Voice VLAN is to safeguard the sound quality of an IP phone in cases where there is high data traffic on the port.

The device uses the source MAC address to identify and prioritize the voice data flow. Using a MAC address to identify devices helps prevent a rogue client from connecting to the same port causing the voice traffic to deteriorate.

Another benefit of the Voice VLAN feature is that a VoIP phone obtains a VLAN ID or priority information using LLDP-MED. As a result, the VoIP phone sends voice data as tagged, priority tagged or untagged. This depends on the Voice VLAN Interface configuration.

The following Voice VLAN interface modes are possible. The first 3 methods segregate and prioritize voice and data traffic. Traffic segregation results in an increased voice traffic quality during high traffic periods.

- ▶ Configuring the port to using the `vlan` mode lets the device tag the voice data coming from a VoIP phone with the user-defined voice VLAN ID. The device assigns regular data to the default port VLAN ID.
- ▶ Configuring the port to use the `dot1p-priority` mode lets the device tag the data coming from a VoIP phone with VLAN 0 and the user-defined priority. The device assigns the default priority of the port to regular data.
- ▶ Configure both the voice VLAN ID and the priority using the `vlan/dot1p-priority` mode. In this mode the VoIP phone sends voice data with the user-defined voice VLAN ID and priority information. The device assigns the default PVID and priority of the port to regular data.
- ▶ When configured as `untagged`, the phone sends untagged packets.
- ▶ When configured as `none`, the phone uses its own configuration to send voice traffic.



## 12.5 VLAN unaware mode

The *VLAN unaware mode* defines the operation of the device in a LAN segmented by VLANs. The device accepts packets and processes them according to its inbound rules. Based on the IEEE 802.1Q specifications, the function governs how the device processes VLAN tagged packets.

Use the VLAN aware mode to apply the user-defined VLAN topology configured by the network administrator. When the device forwards packets, it uses VLAN tagging in combination with the IP or Ethernet address. The device processes inbound and outbound packets according to the defined rules. VLAN configuration is a manual process.

Use the VLAN unaware mode to forward traffic as received, without any modification. When the device receives packets as tagged, it transmits tagged packets. When the device receives packets as untagged, it transmits untagged packets. Regardless of VLAN assignment mechanisms, the device assigns packets to VLAN ID 1 and to a Multicast group, indicating that the packet flood domain is according to the VLAN.

## 13 Redundancy

### 13.1 Network Topology vs. Redundancy Protocols

When using Ethernet, a significant prerequisite is that data packets follow a single (unique) path from the sender to the receiver. The following network topologies support this prerequisite:

- ▶ Line topology
- ▶ Star topology
- ▶ Tree topology

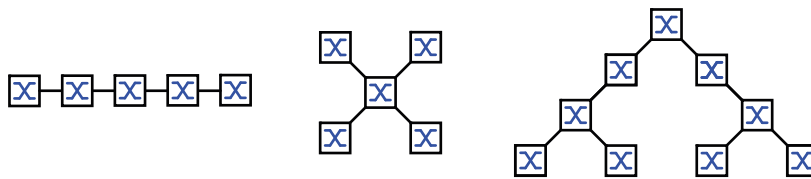

Figure 27: Network with line, star and tree topologies

To maintain communication in case a connection fails, install additional physical connections between the network nodes. Redundancy protocols help ensure that the additional connections remain switched off while the original connection is still working. When the connection fails, the redundancy protocol generates a new path from the sender to the receiver via the alternative connection.

To introduce redundancy onto Layer 2 of a network, you first define which network topology you require. Depending on the network topology selected, you then choose from the redundancy protocols that can be used with this network topology.

#### 13.1.1 Network topologies

##### Meshed topology

For networks with star or tree topologies, redundancy procedures are only possible in connection with physical loop creation. The result is a meshed topology.

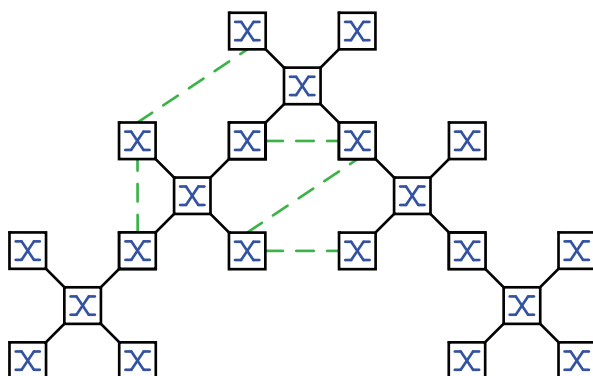

Figure 28: Meshed topology: Tree topology with physical loops

For operating in this network topology, the device provides you with the following redundancy protocols:

- ▶ Rapid Spanning Tree (RSTP)

### Ring topology

In networks with a line topology, you can use redundancy procedures by connecting the ends of the line. This creates a ring topology.

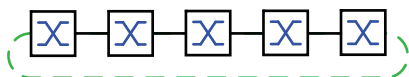

Figure 29: Ring topology: Line topology with connected ends

For operating in this network topology, the device provides you with the following redundancy protocols:

- ▶ Media Redundancy Protocol (MRP)
- ▶ High-availability Seamless Redundancy (HSR) (depends on hardware)
- ▶ Rapid Spanning Tree (RSTP)

### 13.1.2 Redundancy Protocols

For operating in different network topologies, the device provides you with the following redundancy protocols:

Table 26: Overview of redundancy protocols

Redundancy protocol	Network topology	Comments
MRP	Ring	The switching time can be selected and is practically independent of the number of devices. An MRP-Ring consists of up to 50 devices that support the MRP protocol according to IEC 62439. When you only use Hirschmann devices, up to 100 devices are possible in the MRP-Ring.
Fast MRP	Ring	The devices with hardware for enhanced redundancy functions offer the short failover times 30ms and 10ms.
DLR	Ring	Implementation in EtherNet/IP end-devices that have 2 Ethernet ports and embedded Layer 2 switch technology. The DLR protocol provides network fault detection and reconfiguration to support demanding control applications.
PRP	Random structure of the PRP LANs	Uninterrupted availability. On the path from the sender to the receiver, PRP transports a data packet in parallel via 2 mutually independent LANs.
HSR	Ring	Uninterrupted availability. On the path from the sender to the receiver, HSR transports the data packets in both directions via a ring.

Table 26: Overview of redundancy protocols (cont.)

Redundancy protocol	Network topology	Comments
RSTP	Random structure	The switching time depends on the network topology and the number of devices. ▶ typ. < 1 s with RSTP ▶ typ. < 30 s with STP
Link Aggregation	Random structure	A Link Aggregation Group is the combining of 2 or more, full-duplex point-to-point links operating at the same rate, on a single switch to increase bandwidth.
Link Backup	Random structure	When the device detects an error on the primary link, the device transfers traffic to the backup link. You typically use Link Backup in service-provider or enterprise networks.

**Note:** If you are using a redundancy function, then you deactivate the flow control on the participating device ports. If the flow control and the redundancy function are active at the same time, it is possible that the redundancy function operates differently than intended.

### 13.1.3 Combinations of Redundancies

Table 27: Overview of redundancy protocols

	MRP	RSTP	Link Aggreg.	Link Backup	Fast MRP	DLR	HSR	PRP
MRP	▲							
RSTP	▲ <sup>1)</sup>	▲						
Link Aggreg.	▲ <sup>2)</sup>	▲ <sup>2)</sup>	▲					
Link Backup	▲	▲	▲	▲				
Fast MRP <sup>4)</sup>		▲ <sup>1)</sup>	▲	▲	▲			
DLR <sup>4)</sup>	▲ <sup>1)</sup>	▲ <sup>1)</sup>	▲	▲		▲		
HSR <sup>4)</sup>	▲	▲ <sup>1)</sup>	▲	▲			▲ <sup>4)</sup>	
PRP <sup>4)</sup>	▲	▲ <sup>1)</sup>	▲	▲			A	▲ <sup>4)</sup>

▲ Combination applicable

1) Redundant coupling between these network topologies will possibly lead to data loops.

2) Combination applicable on the same port

4) Available only on port 1 and port 2.

A HSR/PRP coupling: Same PRP ID on every non-HSR port.

## 13.2 Media Redundancy Protocol (MRP)

Since May 2008, the Media Redundancy Protocol (MRP) has been a standardized solution for ring redundancy in the industrial environment.

MRP is compatible with redundant ring coupling, supports VLANs, and is distinguished by very short reconfiguration times.

An MRP-Ring consists of up to 50 devices that support the MRP protocol according to IEC 62439. When you only use Hirschmann devices, up to 100 devices are possible in the MRP-Ring.

When you use the fixed MRP redundant port (Fixed Backup) and the primary ring link fails, the Ring Manager forwards data to the secondary ring link. When the primary link is restored, the secondary link continues to be in use.

### 13.2.1 Network Structure

The concept of ring redundancy lets you construct high-availability ring-shaped network structures.

With the help of the RM (**R**ing**M**anager) function, the two ends of a backbone in a line structure can be closed to a redundant ring. The Ring Manager keeps the redundant line open as long as the line structure is intact. When a segment becomes inoperable, the Ring Manager immediately closes the redundant line, and line structure is intact again.

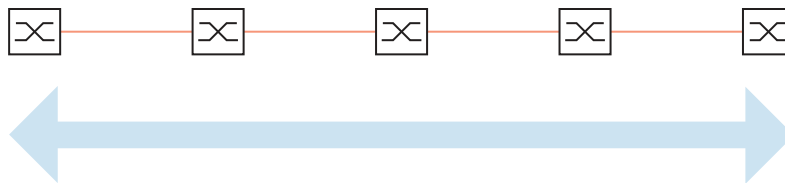

Figure 30: Line structure

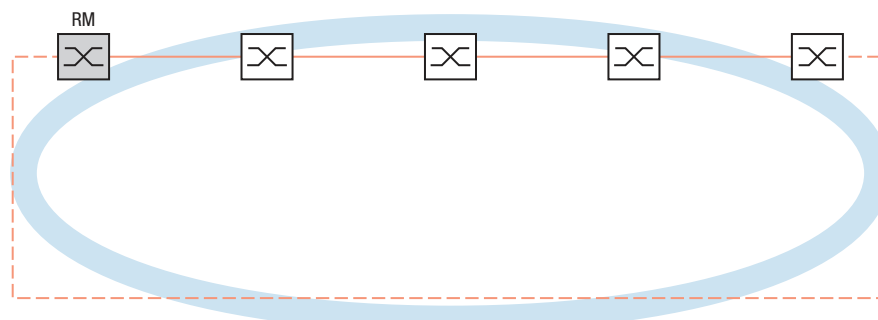

Figure 31: Redundant ring structure  
RM = Ring Manager  
— main line  
- - - redundant line

### 13.2.2 Reconfiguration time

When a line section fails, the Ring Manager changes the MRP-Ring back into a line structure. You define the maximum time for the reconfiguration of the line in the Ring Manager.

Possible values for the maximum delay time:

- 500 ms
- 200 ms
- 30 ms (depends on hardware)
- 10 ms (depends on hardware)

The delay times 30ms and 10ms are available for devices with an FPGA (hardware for extended functions).

In order to use these fast delay times, load the Fast MRP device software.

You can set the delay time to 10ms, only in rings containing up to 20 devices that support this delay time. If you use more than 20 of these devices in the ring, then set the delay time to at least 30ms.

**Note:** If every device in the ring supports the shorter delay time, then you can configure the reconfiguration time with a value less than 500 ms.

Otherwise the devices that only support longer delay times might not be reachable due to overloading. Loops can occur as a result.

### 13.2.3 Advanced mode

For times even shorter than the specified reconfiguration times, the device provides the advanced mode. When the ring participants inform the Ring Manager of interruptions in the ring via link-down notifications, the advanced mode speeds up the link failure recognition.

Hirschmann devices support link-down notifications. Therefore, you generally activate the advanced mode in the Ring Manager.

When you are using devices that do not support link-down notifications, the Ring Manager reconfigures the line in the selected maximum reconfiguration time.

### 13.2.4 Prerequisites for MRP

Before setting up an MRP-Ring, verify that the following conditions are fulfilled:

- ▶ All ring participants support MRP.
- ▶ The ring participants are connected to each other via the ring ports. Apart from the device's neighbors, no other ring participants are connected to the respective device.
- ▶ All ring participants support the configuration time specified in the Ring Manager.
- ▶ There is only one Ring Manager in the ring.

If you are using VLANs, then configure every ring port with the following settings:

- Deactivate ingress filtering - see the [Switching > VLAN > Port](#) dialog.
- Define the port VLAN ID (PVID) - see the [Switching > VLAN > Port](#) dialog.
  - PVID = 1 in cases where the device transmits the MRP data packets untagged (VLAN ID = 0 in [Switching > L2-Redundancy > MRP](#) dialog)  
By setting the PVID = 1, the device automatically assigns the received untagged packets to VLAN 1.
  - PVID = any in cases where the device transmits the MRP data packets in a VLAN (VLAN ID  $\geq 1$  in the [Switching > L2-Redundancy > MRP](#) dialog)
- Define egress rules - see [Switching > VLAN > Configuration](#) dialog.
  - U (untagged) for the ring ports of VLAN 1 in cases where the device transmits the MRP data packets untagged (VLAN ID = 0 in the [Switching > L2-Redundancy > MRP](#) dialog, the MRP ring is not assigned to a VLAN).
  - T (tagged) for the ring ports of the VLAN which you assign to the MRP ring. Select T, in cases where the device transmits the MRP data packets in a VLAN (VLAN ID  $\geq 1$  in the [Switching > L2-Redundancy > MRP](#) dialog).

### 13.2.5 Example Configuration

A backbone network contains 3 devices in a line structure. To increase the availability of the network, you convert the line structure to a redundant ring structure. Devices from different manufacturers are used. All devices support MRP. On every device you define ports 1.1 and 1.2 as ring ports.

When the primary ring link fails, the Ring Manager sends data on the secondary ring link. When the primary link is restored, the secondary link reverts back to the backup mode.

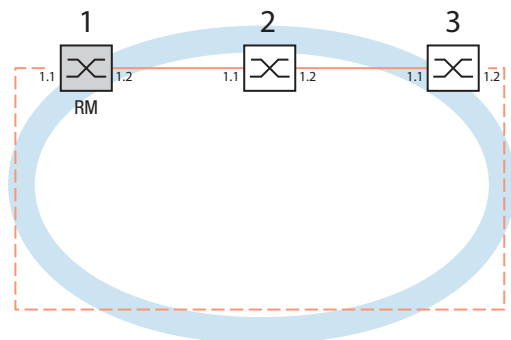

Figure 32: Example of MRP-Ring  
RM = Ring Manager  
— main line  
- - - redundant line

The following example configuration describes the configuration of the Ring Manager device (1). You configure the 2 other devices (2 to 3) in the same way, but without activating the *Ring manager* function. This example does not use a VLAN. You specify 200 ms as the ring recovery time. Every device supports the advanced mode of the Ring Manager.

- Set up the network to meet your demands.
- Configure every port so that the transmission speed and the duplex settings of the lines correspond to the following table:

Table 28: Port settings for ring ports

Port type	Bit rate	Port on	Automatic configuration	Manual configuration
TX	100 Mbit/s	marked	unmarked	100 Mbit/s FDX
TX	1 Gbit/s	marked	marked	–
Optical	100 Mbit/s	marked	unmarked	100 Mbit/s FDX
Optical	1 Gbit/s	marked	marked	–

**Note:** You configure optical ports without support for autonegotiation (automatic configuration) with 100 Mbit/s full duplex (FDX) or 1000 Mbit/s full duplex (FDX).

**Note:** You configure optical ports without support for autonegotiation (automatic configuration) with 100 Mbit/s full duplex (FDX).

**Note:** Configure every device of the MRP-Ring individually. Before you connect the redundant line, verify that you have completed the configuration of every device of the MRP-Ring. You thus help avoid loops during the configuration phase.

You deactivate the flow control on the participating ports.

If the flow control and the redundancy function are active at the same time, it is possible that the redundancy function operates differently than intended. (Default setting: flow control deactivated globally and activated on every port.)

Disable the *Spanning Tree* function in every device in the network. To do this, perform the following steps:

- Open the *Switching > L2-Redundancy > Spanning Tree > Global* dialog.
- Disable the function.  
In the state on delivery, Spanning Tree is enabled in the device.

enable	Change to the Privileged EXEC mode.
configure	Change to the Configuration mode.
no spanning-tree operation	Switches Spanning Tree off.
show spanning-tree global	Displays the parameters for checking.



Enable MRP on every device in the network. To do this, perform the following steps:

- Open the [Switching > L2-Redundancy > MRP](#) dialog.
- Specify the desired ring ports.

**Note:** If the device uses the software supporting Fast MRP, then you cannot select a [Link Aggregation](#) port as a ring port.

In the Command Line Interface you first define an additional parameter, the MRP domain ID. Configure every ring participant with the same MRP domain ID. The MRP domain ID is a sequence of 16 number blocks (8-bit values).

When configuring with the Graphical User Interface, the device uses the default value `255 255 255 255 255 255 255 255 255 255 255 255 255 255 255`.

<code>mrp domain add default-domain</code>	Creates a new MRP domain with the ID <code>default-domain</code> .
<code>mrp domain modify port primary 1/1</code>	Specifies port <code>1/1</code> as ring port <code>1</code> .
<code>mrp domain modify port secondary 1/2</code>	Specifies port <code>1/2</code> as ring port <code>2</code> .

Enable the [Fixed backup](#) port. To do this, perform the following steps:

- Enable the Ring Manager.  
For the other devices in the ring, leave the setting as [Off](#).
- To allow the device to continue sending data on the secondary port after the ring is restored, mark the [Fixed backup](#) checkbox.

**Note:** When the device reverts back to the primary port, the maximum ring recovery time can be exceeded.

When you unmark the [Fixed backup](#) checkbox, and the ring is restored, the Ring Manager blocks the secondary port and unblocks the primary port.

<code>mrp domain modify port secondary 1/2 fixed-backup enable</code>	Activates the <a href="#">Fixed backup</a> function on the secondary port. The secondary port continues forwarding data after the ring is restored.
---	---

- Enable the Ring Manager.  
For the other devices in the ring, leave the setting as [Off](#).

<code>mrp domain modify mode manager</code>	Specifies that the device operates as the <a href="#">Ring manager</a> . For the other devices in the ring, leave the default setting.
---	--

- Select the checkbox in the [Advanced mode](#) field.

`mrp domain modify advanced-mode enabled` Activates the advanced mode.

In the *Ring recovery* field, select the value `200ms`.

`mrp domain modify recovery-delay 200ms` Specifies the value `200ms` as the max. delay time for the reconfiguration of the ring.

**Note:** If selecting 200 ms for the ring recovery does not provide the ring stability necessary to meet the requirements of your network, then select 500 ms.

- Switch the operation of the MRP-Ring on.
- Save the changes temporarily. To do this, click the  button.

`mrp domain modify operation enable` Activates the MRP-Ring.

When every ring participant is configured, close the line to the ring. To do this, you connect the devices at the ends of the line via their ring ports.

Check the messages from the device. To do this, perform the following steps:

`show mrp` Displays the parameters for checking.

The *Operation* field displays the operating state of the ring port.

Possible values:

- ▶ *forwarding*  
The port is enabled, connection exists.
- ▶ *blocked*  
The port is blocked, connection exists.
- ▶ *disabled*  
The port is disabled.
- ▶ *not-connected*  
No connection exists.

The *Information* field displays messages for the redundancy configuration and the possible causes of errors.

When the device is operating as a ring client or a Ring Manager, the following messages are possible:

- ▶ *Redundancy available*  
The redundancy is set up. When a component of the ring is down, the redundant line takes over its function.
- ▶ *Configuration error: Error on ringport link.*  
Error in the cabling of the ring ports.

When the device is operating as a Ring Manager, the following messages are possible:

- ▶ *Configuration error: Packets from another ring manager received.*  
Another device exists in the ring that is operating as the Ring Manager. Activate the *Ring manager* function on exactly one device in the ring.
- ▶ *Configuration error: Ring link is connected to wrong port.*  
A line in the ring is connected with a different port instead of with a ring port. The device only receives test data packets on one ring port.

When applicable, integrate the MRP ring into a VLAN. To do this, perform the following steps:

- In the *VLAN ID* field, define the MRP VLAN ID. The MRP VLAN ID determines in which of the configured VLANs the device transmits the MRP packets. To set the MRP VLAN ID, first configure the VLANs and the corresponding egress rules in the *Switching > VLAN > Configuration* dialog.
  - If the MRP-Ring is not assigned to a VLAN (like in this example), then leave the VLAN ID as 0.  
In the *Switching > VLAN > Configuration* dialog, specify the VLAN membership as **U** (untagged) for the ring ports in VLAN 1.
  - If the MRP-Ring is assigned to a VLAN, then enter a VLAN ID >0.  
In the *Switching > VLAN > Configuration* dialog, specify the VLAN membership as **T** (tagged) for the ring ports in the selected VLAN.

```
mrp domain modify vlan <0..4042> Assigns the VLAN ID.
```

## 13.3 Parallel Redundancy Protocol (PRP) (depends on hardware)

Unlike ring redundancy protocols, PRP uses 2 separate LANs for uninterrupted availability. On the path from the sender to the receiver, PRP sends 2 data packets in parallel via the 2 mutually independent LANs. The receiver processes the first data packet received and discards the second data packet of the pair. The international standard IEC 62439-3 defines the Parallel Redundancy Protocol (PRP).

**Note:** When PRP is active, it uses the interfaces 1/1 and 1/2. As seen in the [Switching > VLAN](#), [Switching > Rate Limiter](#) and [Switching > Filter for MAC Addresses](#) dialogs, the *PRP* function replaces the interfaces 1/1 and 1/2 with the interface prp/1. Configure the VLAN membership, the rate limiting, and the MAC filtering for the interface prp/1.

### 13.3.1 Implementation

When the upper protocol layers send a data packet, the PRP interface creates a “twin packet” from the original packet. The PRP interface then transmits one data packet of the pair to each participating LAN simultaneously. The packets traverse different LANs and therefore have different run times.

The receiving PRP interface forwards the first packet of a pair towards the upper protocol layers and discards the second packet. When viewed from the application, a PRP interface functions like a standard Ethernet interface.

The PRP interface or a Redundancy Box (RedBox) injects a Redundancy Control Trailer (RCT) into each packet. The RCT is a 48-bit identification field and is responsible for the identification of duplicates. This field contains, LAN identification (LAN A or B), information about the length of the payload, and a 16-bit sequence number. The twin packets therefore differ only in the LAN identification and as a result in the FCS checksum. The PRP interface increments the sequence number for each packet sent. Using the unique attributes included in each packet, such as Physical MAC source address and sequence number, the receiving RedBox or Double Attached Node (DAN) interface identifies and discards duplicates.

Depending on the packet size, with PRP it attains a reduced throughput of the available bandwidth, due to the addition of the RCT trailer.

### 13.3.2 LRE functionality

Each Double Attached Node implementing PRP (DANP) has 2 LAN ports that operate in parallel. The Link Redundancy Entity (LRE) connects the upper protocol layers with every individual port.

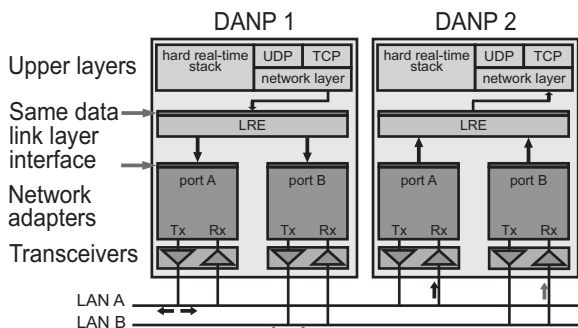

Figure 33: PRP LRE process

The LRE has the following tasks:

- ▶ Handling of duplicates
- ▶ Management of redundancy

When transmitting packets from the upper protocol layers, the LRE sends them from both ports at nearly the same time. The 2 data packets pass through the LANs with different delays. When the device receives the first data packet, the LRE forwards it to the upper protocol layers and discards the second data packet received.

For the upper protocol layers, the LRE behaves like a normal port.

To identify the twin packets, the LRE attaches an RCT with a sequential number to the packets. The LRE also periodically sends multicast PRP supervision packets and evaluates the multicast PRP supervision packets of the other RedBoxes and DANPs.

The device lets you view the received supervision packet entries. The entries in the [Switching > L2-Redundancy > PRP > DAN/VDAN Table](#) are helpful for detecting redundancy and connection problems. For example, in an index the *Last seen B* timestamp resets and the *Last seen A* timestamp remains the same. The *Last seen A* and *Last seen B* timestamps steadily resetting indicate a normal condition.

**Note:** According to IEC 62439, the Entry Forget Time is 400 ms. The Entry Forget Time is the time after which the device removes an entry from the duplicate table. When the device receives the 2nd packet of a pair after 400 ms or later, the device processes the 2nd packet instead of discarding it. To help prevent this, Hirschmann recommends that you use a maximum bandwidth of 90%.

**Note:** If the inter-frame gap is shorter than the latency between the 2 LANs, then a frame-ordering mismatch can occur. Frame-ordering mismatch is a phenomenon of the PRP protocol. The only solution to help avoid a frame-ordering mismatch is to verify that the inter-frame gap is greater than the latency between the LANs.

### 13.3.3 PRP Network Structure

PRP uses 2 independent LANs. The topology of each of these LANs is arbitrary, and ring, star, bus and meshed topologies are possible.

The main advantage of PRP is zero recovery time with an active (transit) LAN. When the end device receives no packets from one of the LANs, the second (transit) LAN maintains the connection. As long as one (transit) LAN is available, repairs and maintenance on the other (transit) LAN have no impact on the data packet transmission.

The elementary devices of a PRP network are the RedBox (Redundancy Box) and the DANP (Double Attached Node implementing PRP). Both devices have one connection each to the (transit) LANs.

The devices in the (transit) LAN are conventional switches. The devices transmit PRP data packets transparently, without evaluating the RCT information.

**Note:** The RCT trailer increases the packet size by 6 bytes. Configure the MTU size  $\geq 1524$  bytes for LAN A and B devices.

Terminal devices that connect directly to a device in the (transit) LAN are SANs (Single Attached Nodes). SANs connected to a LAN have no redundancy. To use the PRP redundant network, connect the SAN to the PRP network via a RedBox.

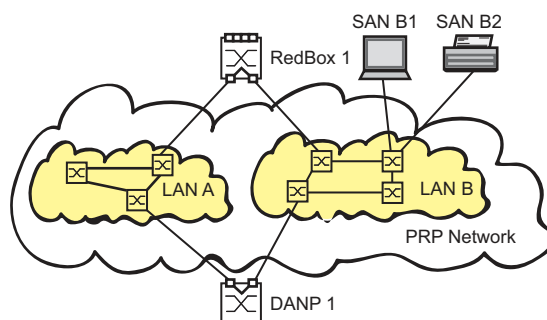

Figure 34: Parallel Redundancy Protocol Network

### 13.3.4 Connecting RedBoxes and DANPs to a PRP network

DANPs have 2 interfaces for the connection to the PRP network. A RedBox is a DANP that contains additional switch ports. Use the switch ports to integrate one or more SANs into the PRP network redundantly.

When sending a data packet to the PRP network, the Link Redundancy Entity (LRE) in the RedBox creates a twin packet. When the LRE receives the first data packet of the twin pair, the LRE forwards the data packet, and discards the second data packet of the twin pair.

**Note:** The Redbox supports up to 128 hosts. If you attempt to support more than 128 hosts with the Redbox, then device drops packets.

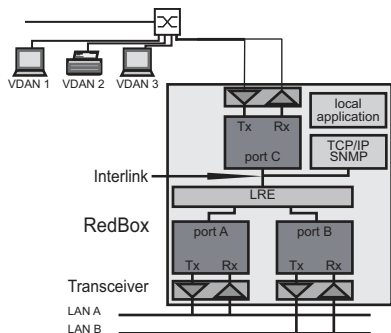

Figure 35: RedBox Transition from double to single LAN

### 13.3.5 Example Configuration

The following example uses a simple PRP network with 4 devices. Verify that the LAN A and LAN B ports contain 100 Mbit/s optical SFP interfaces. Connect Port A to LAN A and the Port B to LAN B.

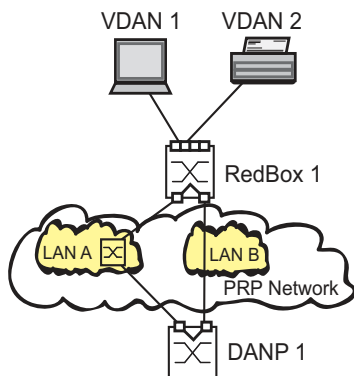





Figure 36: Example PRP Network

**Note:** *PRP* is available for devices with an FPGA (hardware for extended functions). The product code indicates if your device supports *PRP*. In order to use the functions, load the device software supporting *PRP*.

The *PRP* function reserves ports 1/1 and 1/2. This removes the possibility of using other redundancy protocols such as Spanning Tree or MRP in parallel on ports 1/1 and 1/2.

- If you use Spanning Tree in parallel to PRP, then deactivate Spanning Tree on ports 1/1 and 1/2. Also deactivate the *Root guard*, *TCN guard*, and *Loop guard* functions on ports 1/1 and 1/2.
- If you use MRP in parallel to PRP, then specify the other free device ports as MRP-Ring ports.

Configure both the RedBox 1 and DANP 1 devices. To do this, perform the following steps:

- Open the [Switching > L2-Redundancy > PRP > Configuration](#) dialog.
- In the [Supervision packet receiver](#) frame, perform the following step:
  - To analyze received PRP supervision packets, activate the [Evaluate supervision packets](#) checkbox.
- In the [Supervision packet sender](#) frame, perform the following steps:
  - To transmit PRP supervision packets from this device, activate [Active](#).
  - The device sends either only its own PRP supervision packets, or sends both its own supervision packets and packets of connected devices. To transmit packets for VDANs listed in the [Switching > L2-Redundancy > PRP > DAN/VDAN Table](#), mark the [Send VDAN packets](#) checkbox. When deactivated, the device forwards only its own supervision packets. After installing new PRP devices, deactivate this function to maintain a clear overview of the PRP supervision packets on remote devices.
  - To enable the ports, in the [Port A](#) and [Port B](#) frames, select the value [On](#).
  - To enable the function, select in the [Operation](#) frame the [On](#) radio button.
  - Save the changes temporarily. To do this, click the  button.
  - To load the configuration saved in the volatile memory, click the  button.
  - Open the [Switching > L2-Redundancy > PRP > Proxy Node Table](#) dialog to view the terminating VDAN devices for which this device provides PRP conversion.
  - To remove this list, click [Reset](#).
  - To load the list of currently connected devices, click the  button.
  - Open the [Switching > L2-Redundancy > PRP > Statistics](#) dialog to view the quality of the traffic that traverses the device. The device detects errors and displays them according to MIB Managed Objects and the respective link.
  - To remove the entry in the statistics table, click [Reset](#).
  - To load the current statistics, click the  button.

The device lets you view the received supervision packet entries. The entries in the [Switching > L2-Redundancy > PRP > DAN/VDAN Table](#) are helpful for detecting redundancy and connection problems. For example, in an index the [Last seen B](#) timestamp resets and the [Last seen A](#) timestamp remains the same. The [Last seen A](#) and [Last seen A](#) timestamps steadily resetting indicate a normal condition.

**Note:** If you deactivate the [PRP](#) function, then deactivate either Port “A” or “B” to help prevent network loops.

<code>enable</code>	Change to the Privileged EXEC mode.
<code>configure</code>	Change to the Configuration mode.
<code>no mrp operation</code>	Disable the option.
<code>no spanning-tree operation</code>	Disable the option.
<code>interface 1/1</code>	Change to the interface configuration mode of interface <a href="#">1/1</a> .
<code>no shutdown</code>	Enable the interface.
<code>exit</code>	Change to the Configuration mode.
<code>interface 1/2</code>	Change to the interface configuration mode of interface <a href="#">1/2</a> .
<code>no shutdown</code>	Enable the interface.
<code>exit</code>	Change to the Configuration mode.



<pre>prp instance 1 supervision evaluate</pre>	Enable evaluation of received supervision packets.
<pre>prp instance 1 supervision send</pre>	Enable supervision packet transmission.
<pre>prp instance 1 supervision redbox-exclusively</pre>	Sends supervision packets only for this RedBox. Use the <code>no</code> form of the command to send supervision packets for each connected VDAN and this RedBox. The prerequisite is that you enable the supervision packet send function.
<pre>prp operation</pre>	Enable the <i>PRP</i> function.
<pre>show prp counters</pre>	Display the PRP counters.
<pre>show prp node-table</pre>	Display the node table.
<pre>show prp proxy-node-table</pre>	Display the proxy node table.

## 13.4 High-availability Seamless Redundancy (HSR) (depends on hardware)

As with PRP, an HSR ring also offers zero recovery time. HSR is suited for applications that demand high availability and short reaction times. For example, protection applications for electrical station automation and controllers for synchronized drives which require constant connection.

**Note:** When HSR is active, it uses the interfaces 1/1 and 1/2. As seen in the [Switching > Rate Limiter](#) and [Switching > Filter for MAC Addresses](#) dialogs, the *HSR* function replaces the interfaces 1/1 and 1/2 with the interface hsr/1. Set up the VLAN membership and the rate limiting for the interface hsr/1.

### 13.4.1 Implementation

HSR Redundancy Boxes (RedBox) use 2 Ethernet ports operating in parallel to connect to a ring. An HSR RedBox operating in this configuration is a Doubly Attached Node implementing the HSR protocol (DANH). A standard ethernet device connected to the HSR ring through an HSR RedBox is a Virtual DANH (VDANH).

As with PRP, the transmitting HSR Node or HSR RedBox sends twin packets, one in each direction, on the ring. For identification, the HSR node injects the twin packets with an HSR tag. The HSR tag consists of a port identifier, the length of the payload and a sequence number. In a normal operating ring, the destination HSR node or RedBox receives both packets within a certain time skew. When the HSR node receives the first packet, the HSR node forwards the packet, and discards the 2nd packet. A RedBox on the other hand forwards the first packet to the VDANHs and discards the second packet.

The HSR Nodes and HSR RedBoxes insert an HSR tag after the source MAC Address in the packet. The advantage to the HSR tag placement is that the device is able to forward the packet immediately after receiving the HSR header and performing duplicate recognition. Affectively decreasing the delay time within the device. In contrast to PRP where the RCT contains a PRP suffix near the end of the packet. Meaning that a PRP device receives the entire packet before forwarding the packet out of the correct port.

HSR Nodes and HSR RedBoxes also use the LRE function as described in the chapter [“Parallel Redundancy Protocol \(PRP\) \(depends on hardware\)” on page 177](#). As with PRP, the LRE in the HSR RedBoxes are responsible for tagging and duplicate recognition.

The number of HSR nodes in the ring should not exceed 50. If the HSR interface speed is *1Gbps*, then the number should not exceed 300.

It is useful to limit the traffic injected into the HSR ring. If there are any third party devices with a higher latency in the ring, then you reduce the number of ring participants. Verify that the sum of bandwidths applied to the HSR nodes is less than 84 %.

**Note:** *HSR* is available for devices with an FPGA (hardware for extended functions). The product code indicates if your device supports *HSR*. In order to use the functions, load the device software supporting *HSR*.

### 13.4.2 HSR Network Structure

An HSR Network consists of a ring, where each HSR device performs a specific role in the network. An HSR device for example, connects standard ethernet devices to an HSR ring, or PRP LANs to an HSR ring.

#### Connecting SANs to an HSR Network

Standard ethernet devices, such as laptops or printers, have one network interface. Therefore, standard ethernet devices transmit traffic across an HSR ring through an HSR RedBox which acts as a proxy for the ethernet devices attached to it. The HSR RedBox interfaces transmit one twin packet in each direction around the network.

The host HSR RedBox forwards only the first unicast packet to the destination VDANH and discards the second unicast packet.

The HSR Nodes and RedBoxes forward multicast and broadcast traffic around the ring and also to the connected VDANH devices. To help prevent the traffic from endlessly looping around the ring, the node originally transmitting the traffic on the network discards the data packets it transmitted.

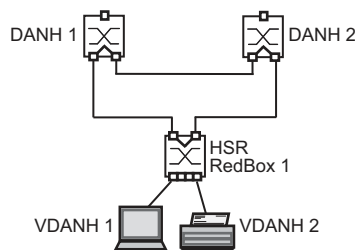

Figure 37: Connecting a VDANH to an HSR network

#### SAN Device Connection Example Configuration

A simple HSR network consists of 3 HSR devices as seen in the previous figure. The following example configures a host HSR RedBox for standard ethernet devices.

Deactivate STP on the PRP ports or globally. Also, deactivate MRP on the PRP ports or configure MRP on ports other than the PRP ports.

Perform the following steps:

- Open the [Switching > L2-Redundancy > MRP](#) dialog.
- To disable the function, select the [Off](#) radio button in the [Operation](#) frame.
- Verify that the ports in [Ring port 1](#) and [Ring port 2](#) frames are different from the ports used by the [HSR](#) function.
- Open the [Switching > L2-Redundancy > Spanning Tree > Global](#) dialog.
- To disable the function, select the [Off](#) radio button in the [Operation](#) frame.
- Open the [Switching > L2-Redundancy > Spanning Tree > Port](#) dialog.
- In the [CIST](#) tab, deactivate the ports used for HSR in the [STP active](#) column.
- In the [Guards](#) tab, deactivate the ports used for HSR in the [Root guard](#), [TCN guard](#) and [Loop guard](#) columns.

**Note:** If you deactivate the *HSR* function, then deactivate either Port “A” or “B” to help prevent network loops.

The device sends either only its own HSR supervision packets, or sends both its own supervision packets and packets of connected devices. After installing new HSR devices, deactivate this function to maintain a clear overview of the HSR supervision packets on remote devices.





Perform the following steps:

- Open the *Switching > L2-Redundancy > HSR > Configuration* dialog.
- To analyze received HSR supervision packets, activate the *Evaluate supervision packets* checkbox in the *Supervision packet receiver* frame.
- To transmit HSR supervision packets from this device, activate *Active* in the *Supervision packet sender* frame.
- To transmit packets for VDANs listed in the *Switching > L2-Redundancy > HSR > DAN/VDAN Table* dialog, mark the *Send VDAN packets* checkbox.

Configure HSR RedBox 1. To do this, perform the following steps:

- To configure the device to forward unicast traffic around the ring and to the destination device, set the *HSR mode* to *modeu*.
- To configure the device as an HSR host, set *Switching node type* to *hsrredboxsan*.

**Note:** Setting *Switching node type* to *hsrredboxsan* disables the *Redbox identity* function.

- To enable the ports, select the *On* radio button in the Port *Port A* and Port *Port B* frames.
- To enable the function, select the *On* radio button in the *Operation* frame.
- Save the changes temporarily. To do this, click the  button.
- To load the configuration saved in the volatile memory, click the  button.
- Open the *Switching > L2-Redundancy > HSR > DAN/VDAN Table* dialog to view the traffic received from the LAN. This information helps you in detecting how the LANs are functioning.
- To remove this list, click *Reset*.
- To update the table entries, click the  button.
- Open the *Switching > L2-Redundancy > HSR > Proxy Node Table* dialog to view the terminating VDAN devices for which this device provides HSR conversion.
- To remove the entries in the proxy table, click *Reset*.
- To update the table entries, click the  button.

The device detects errors and displays them according to MIB Managed Objects and the respective link.

- Open the *Switching > L2-Redundancy > HSR > Statistics* dialog to view the quality of the traffic that traverses the device.
- To remove the entry in the statistics table, click *Reset*.
- To load the current statistics, click the  button.

Another possibility is to configure the host HSR RedBox 1 using the following commands:

enable	Change to the Privileged EXEC mode.
configure	Change to the Configuration mode.
no mrp operation	Disable the option.
no spanning-tree operation	Disable the option.
interface 1/1	Change to the interface configuration mode of interface <a href="#">1/1</a> .
no shutdown	Enable the interface.
exit	Change to the Configuration mode.
interface 1/2	Change to the interface configuration mode of interface <a href="#">1/2</a> .
no shutdown	Enable the interface.
exit	Change to the Configuration mode.
hsr instance 1 mode modeu	The HSR host forwards unicast traffic to the connected VDANs and around the ring.
hsr instance 1 port-a	Activate the HSR Port <a href="#">A</a> .
hsr instance 1 port-b	Activate the HSR Port <a href="#">B</a> .
hsr instance 1 switching-node-type hsrredboxsan	Enable the device to process traffic destined for LAN B of the PRP network.
hsr instance 1 supervision evaluate	Enable evaluation of received supervision packets.
hsr instance 1 supervision send	Enable supervision packet transmission.
hsr instance 1 supervision redbox-exclusively	Sends supervision packets only for this RedBox. Use the <code>no</code> form of the command to send supervision packets for each connected VDAN and this RedBox. The prerequisite is that you enable the supervision packet send function.
hsr operation	Enable the <a href="#">HSR</a> function.

View traffic statistics on a device using the show commands.

show hsr counters	Display the HSR counters.
show hsr node-table	Display the node table.
show hsr proxy-node-table	Display the proxy node table.

### HSR and PRP network connections

When connecting PRP networks to an HSR network, the HSR device uses 2 interfaces to connect to the HSR ring. The HSR device uses a third interface to connect to either LAN A or LAN B of the PRP network as seen in the following figure. The HSR device transmitting the traffic across the HSR ring identifies traffic destined for PRP networks with the appropriate tag. The HSR devices then forward the PRP traffic through LAN A or LAN B. The PRP device receives the traffic and processes it as described in the PRP chapter.

The HSR devices identify and tag traffic for up to 7 PRP networks connected to one HSR ring.

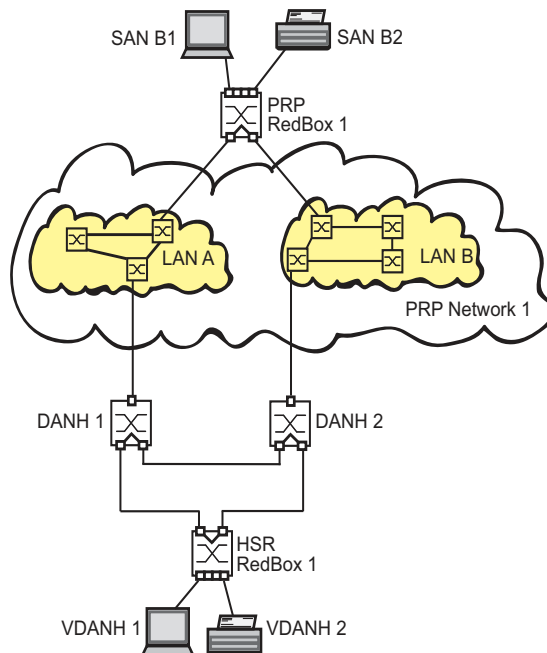

Figure 38: Connecting a PRP network to an HSR network

HSR Redboxes use 2 interfaces for the HSR ring. When configured to manage PRP traffic, a third interface connects to a LAN of the PRP network. The other interfaces provide HSR network access for VDANs. The HSR RedBox lists the connected VDANs in the [Switching > L2-Redundancy > HSR > Proxy Node Table](#).

### PRP Network Connection Example Configuration

The following example configures a simple HSR network with 3 HSR devices as shown in the previous figure. Use the HSR RedBox configured in the previous example to connect the standard ethernet devices to the HSR ring. HSR RedBox 1 sends one twin packet toward DANH 1 and one twin packet toward DANH 2. When the first packet of a pair arrives, DANH 1 sends the packet to PRP network 1 LAN A and DANH 2 sends the packet to PRP network 1 LAN B.

Deactivate STP on the PRP ports or globally. Also, deactivate MRP on the PRP ports or configure MRP on ports other than the PRP ports.

Use the HSR RedBox configured in the previous example for HSR RedBox 1.

For the DANH 1 and 2, perform the following steps:

- Open the *Switching > L2-Redundancy > MRP* dialog.
- To disable the function, select the *Off* radio button in the *Operation* frame.
- Verify that the ports in *Ring port 1* and *Ring port 2* frames are different from the ports used by the *HSR* function.
- Open the *Switching > L2-Redundancy > Spanning Tree > Global* dialog.
- To disable the function, select the *Off* radio button in the *Operation* frame.
- Open the *Switching > L2-Redundancy > Spanning Tree > Port* dialog.
- In the *CIST* tab, deactivate the ports used for HSR in the *STP active* column.
- In the *Guards* tab, deactivate the ports used for HSR in the *Root guard*, *TCN guard* and *Loop guard* columns.

**Note:** If you deactivate the *HSR* function, then deactivate either Port “A” or “B” to help prevent network loops.

The device sends either only its own HSR supervision packets, or sends both its own supervision packets and packets of connected devices. After installing new HSR devices, deactivate this function to maintain a clear overview of the HSR supervision packets on remote devices.

Perform the following steps:

- Open the *Switching > L2-Redundancy > HSR > Configuration* dialog.
- To analyze received HSR supervision packets, activate the *Evaluate supervision packets* checkbox in the *Supervision packet receiver* frame.
- To transmit HSR supervision packets from this device, activate *Active* in the *Supervision packet sender* frame.
- To transmit packets for VDANs listed in the *Switching > L2-Redundancy > HSR > DAN/VDAN Table* dialog, mark the *Send VDAN packets* checkbox.

Configure DANH 1. To do this, perform the following steps:

- Open the *Switching > L2-Redundancy > HSR > Configuration* dialog.
- To configure the device to forward unicast traffic around the ring and to the destination device, set the *HSR mode* to *modeu*.
- To configure the device to forward traffic to PRP LAN A, set the *Switching node type* to *hsrredboxprpa*.
- To configure the device to forward traffic to PRP network 1 LAN A, set *Redbox identity* to *id1a*.
- To enable the ports, select the *On* radio button in the Port *Port A* and Port *Port B* frames.
- To enable the function, select the *On* radio button in the *Operation* frame.
- Save the changes temporarily. To do this, click the  button.
- To load the configuration saved in the volatile memory, click the  button.

Configure DANH 2. To do this, perform the following steps:

- Open the [Switching > L2-Redundancy > HSR > Configuration](#) dialog.
- To configure the device to forward unicast traffic around the ring and to the destination device, set the *HSR mode* to `modeu`.
- To configure the device to forward traffic to PRP LAN A, set the *Switching node type* to `hsrredboxprpb`.
- To configure the device to forward traffic to PRP network 1 LAN B, set *Redbox identity* to `id1b`.
- To enable the ports, select the *On* radio button in the Port *Port A* and Port *Port B* frames.
- To enable the function, select the *On* radio button in the *Operation* frame.
- Save the changes temporarily. To do this, click the  button.
- To load the configuration saved in the volatile memory, click the  button.

Another possibility is to use the following commands to configure the HSR devices 1 and 2. To do this, perform the following steps:

<code>enable</code>	Change to the Privileged EXEC mode.
<code>configure</code>	Change to the Configuration mode.
<code>no mrp operation</code>	Disable the option.
<code>no spanning-tree operation</code>	Disable the option.
<code>interface 1/1</code>	Change to the interface configuration mode of interface <code>1/1</code> .
<code>no shutdown</code>	Enable the interface.
<code>exit</code>	Change to the Configuration mode.
<code>interface 1/2</code>	Change to the interface configuration mode of interface <code>1/2</code> .
<code>no shutdown</code>	Enable the interface.
<code>exit</code>	Change to the Configuration mode.

Configure DANH 1 to process traffic for PRP network 1 LAN A. To do this, perform the following steps:

<code>hsr instance 1 mode modeu</code>	The HSR host forwards unicast traffic to the connected VDANs and around the ring.
<code>hsr instance 1 port-a</code>	Activate the HSR Port <i>A</i> .
<code>hsr instance 1 port-b</code>	Activate the HSR Port <i>B</i> .
<code>hsr instance 1 switching-node-type hsrredboxprpa</code>	Enable the device to process traffic destined for LAN A of the PRP network.
<code>hsr instance 1 redbox-id id1a</code>	Enable the device to process traffic destined for LAN A of the PRP network 1.
<code>hsr instance 1 supervision evaluate</code>	Enable evaluation of received supervision packets.



```
hsr instance 1 supervision send
```

```
hsr instance 1 supervision
redbox-exclusively
```

```
hsr operation
```

Enable supervision packet transmission.

Sends supervision packets only for this RedBox. Use the `no` form of the command to send supervision packets for each connected VDAN and this RedBox. The prerequisite is that you enable the supervision packet send function.

Enable the *HSR* function.

Configure DANH 2 to process traffic for PRP network 1 LAN B. To do this, perform the following steps:

```
hsr instance 1 mode modeu
```

```
hsr instance 1 port-a
```

```
hsr instance 1 port-b
```

```
hsr instance 1 switching-node-type
hsrredboxprpb
```

```
hsr instance 1 redbox-id idlb
```

```
hsr instance 1 supervision evaluate
```

```
hsr instance 1 supervision send
```

```
hsr instance 1 supervision
redbox-exclusively
```

```
hsr operation
```

The HSR host forwards unicast traffic to the connected VDANs and around the ring.

Activate the HSR Port [A](#).

Activate the HSR Port [B](#).

Enable the device to process traffic destined for LAN B of the PRP network.

Enable the device to process traffic destined for LAN B of the PRP network 1.

Enable evaluation of received supervision packets.

Enable supervision packet transmission.

Sends supervision packets only for this RedBox. Use the `no` form of the command to send supervision packets for each connected VDAN and this RedBox. The prerequisite is that you enable the supervision packet send function.

Enable the *HSR* function.

View traffic statistics on a device using the show commands.

Perform the following steps:

```
show hsr counters
```

```
show hsr node-table
```

```
show hsr proxy-node-table
```

Display the HSR counters.

Display the node table.

Display the proxy node table.

## 13.5 Device Level Ring (DLR)

The Device Level Ring (DLR) protocol is a Layer 2 protocol that provides redundancy for Ethernet data using a ring topology. The primary implementation for the DLR protocol is to control and monitor EtherNet/IP devices.

The DLR protocol operates at Layer 2 in the OSI model. The presence of the ring topology and the operation of the DLR protocol are transparent to higher layer protocols such as TCP/IP and EtherNet/IP. The DLR protocol is transparent with the exception of a DLR Object. The DLR Object provides a configuration and diagnostic interface for the EtherNet/IP protocol.

The DLR protocol also lets you install non-DLR multi-port Layer 2 switches in the ring. Non-DLR Layer 2 switches are subject to certain restrictions. For example, the Layer 2 switch has the MAC table filtering disabled. Non-DLR devices have an impact on the ring recovery time.

In the delivery setting the function is disabled.

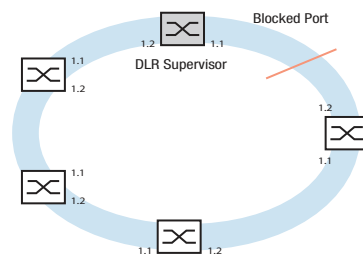

Figure 39: DLR Network with ring participants

### 13.5.1 Device Roles

A DLR network includes at least one ring supervisor, and a DLR capable ring participant. Every participant in the ring has at least 2 Ethernet ports, and implements Layer 2 switching technology. After a ring participant receives a packet on a ring port, it determines whether to process or forward the packet depending on the MAC address contained in the packet.

#### Active Ring Supervisor

The active ring supervisor is responsible for monitoring and controlling the network. To monitor the network the active ring supervisor uses Beacon and Announce packets. The Beacon packets contain configuration information that the active ring supervisor sends to the ring participants. The ring participants configure their DLR parameters with the information contained in the Beacon packets.

The following list contains the configuration information sent in the Beacon packet:

- ▶ Beacon interval
- ▶ Beacon timeout
- ▶ Supervisor Precedence, entered in the Beacon-based participant configuration only
- ▶ DLR VLAN ID

**Note:** The default VLAN ID used for DLR is 0. Verify that the *VLAN unaware mode* in the *Switching > Global* dialog is activated.

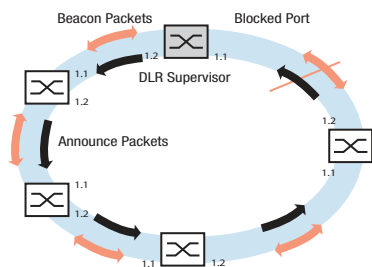

Figure 40: Beacon and Announce packets

An active ring supervisor boots in the FAULT\_STATE and forwards Beacon and Announce packets on both Ethernet ports. During boot up the Beacon and Announce packets contain the value RING\_FAULT\_STATE as the ring state.

Once the active ring supervisor receives Beacon packets on both ports, it transitions the ring state to the NORMAL\_STATE, sets a port to blocking, and flushes its unicast MAC address table. The active ring supervisor continues to send Beacon packets on both ports and sends Announce packets only on the unblocked port. By blocking a ring port, the active ring supervisor provides only one path for the ring participants to send and receive data. The active ring supervisor sends an Announce packet on the forwarding port, with the ring state set to RING\_NORMAL\_STATE.

Since the active ring supervisor is responsible for controlling and monitoring the ring, it needs to know who is on the ring. The active ring supervisor does this by initiating the Sign\_On process.

### Backup Supervisors

When the ring contains multiple supervisors, each supervisor sends Beacon packets during boot up. Besides ring state messages, and configuration information, the Beacon packets also contain a supervisor precedence value. When an active ring supervisor receives a Beacon packet, it checks the precedence value. If the precedence value in the Beacon packet is higher than its own, then the active ring supervisor transitions to the FAULT\_STATE and assumes the backup supervisor role. When the precedence values are the same, the ring supervisor with the numerically higher MAC address assumes the role of the active ring supervisor.

The backup supervisors configure their DLR parameters, except for the supervisor precedence value, and the DLR VLAN ID with the information contained in the Beacon packets. The backup supervisors continue to monitor both ports for a timeout of the Beacon packets. When the backup supervisor times out the Beacon packets on both ports, it waits an extra Beacon Timeout period before sending its Beacon packets.

### Beacon-based Nodes (depends on hardware)

When the supervisor function on a ring participant is inactive, it assumes the role of a Beacon-based participant. Beacon-based participants process both Beacon packets and Announce packets. This makes it possible for a quicker response to detected ring breaks.

A Beacon-based ring participant boots up in the IDLE\_STATE, and presumes the network is a linear topology. Upon receiving a Beacon packet on either the primary or the secondary port, the participant transitions to the FAULT\_STATE, and presumes the network is a ring topology. The ring participant flushes its unicast MAC address table and saves the DLR parameters received in the Beacon packets.

The ring participants save the following DLR parameters in their configuration:

- ▶ Supervisor addresses, MAC and IP address
- ▶ Supervisor precedence
- ▶ Beacon interval
- ▶ Beacon timeout
- ▶ DLR VLAN ID

Upon receiving the Beacon packets on both ports, the ring participant transitions to the NORMAL\_STATE. Then the ring participant flushes its unicast MAC address table.

### Non-DLR Nodes

The DLR protocol does not require that every ring participant implement the protocol. The network administrator can install non-DLR participants in the ring. This assumes that the devices support certain required configurations.

**Note:** Using non-DLR participants in the ring lengthens the recovery time. When possible, connect the non-DLR participants to the ring through a DLR capable device.

If you install non-DLR participants directly in the ring, then the participants require certain configurations. The following list describes the configurations required:

- ▶ Disable unicast MAC address learning.  
Beacon packets arrive on both ports with the MAC address of the active ring supervisor. Address learning causes the MAC address of the active ring supervisor to bounce from port to port.
- ▶ Disable multicast filtering on DLR ring ports.  
The Beacon and Announce packets used in the DLR protocol are multicast messages. When unsupported, the participant filters out the DLR messages.
- ▶ Support the reception of 802.1Q packets and preservation of the VLAN ID and tag priority.  
If unsupported, then the device can drop or incorrectly queue the DLR messages.
- ▶ Implement priority queues with strict priority scheduling.  
Assign the DLR messages the highest priority queue. If unsupported, then the device delays DLR messages. This affects ring recovery performance.

**Note:** Using non-DLR participants can result in loss of unicast packets for some time following a detected error or ring restoration. If the non-DLR participant maintains the MAC address table after a detected error, then the participant can send unicast packets on the wrong port. For this reason, DLR capable participants flush their MAC address table.

## 13.5.2 Error Detection

The active ring supervisor is responsible for ring integrity. In order to control and monitor the ring, the active ring supervisor sends Beacon and Announce packets. The Beacon and Announce packets contain various status messages. The status messages inform the ring participants about the health of the ring.

The ring participants also monitor connections to their neighbors. When a ring participant detects that the link to a neighbor is down, it sends a Link\_Status message to the active ring supervisor.

After receipt of the Link\_Status message, the ring supervisor unblocks its previously blocked port. Unblocking the port transitions the network from a ring to a linear topology. The active ring supervisor then flushes its unicast MAC table, and immediately sends Beacon and Announce packets. The ring state set to RING\_FAULT\_STATE.

### Active Ring Supervisor

The following list contains events in which the active ring supervisor transitions to the FAULT\_STATE:

- ▶ Receiving Beacon packets from another supervisor with a higher precedence value.
- ▶ Loss of Beacon packets on either port for the specified Beacon Timeout period, indicating a break somewhere in the ring.
- ▶ Interruption of link with the neighboring participant detected on either port.
- ▶ Receiving a Link\_Status message from a ring participant, indicating that a ring participant has detected an error.

In the cases listed above, the active ring supervisor responds with the following actions:

- ▶ Transition to FAULT\_STATE
- ▶ Flush the unicast MAC address table
- ▶ Unblock the blocked port
- ▶ Send Beacon packets out both ports, with ring state set to the RING\_FAULT\_STATE
- ▶ Send Announce packets out both ports, with ring state set to the RING\_FAULT\_STATE

When the active ring supervisor times out a Beacon packet, it initiates the Neighbor Check process by sending a Locate Fault packet. The supervisor also sends Neighbor Check packets to the neighbor connected to the ports on which it timed out the Beacon packet.

When in the FAULT\_STATE, the active ring supervisor continues to send Beacon packets. Sending Beacon packets lets the active ring supervisor detect ring restoration.

### Ring Participants

The following list contains events in which the ring participant transitions from the NORMAL\_STATE:

- ▶ Receipt of a Beacon packet with the ring state set to RING\_FAULT\_STATE.
- ▶ Receipt of a Beacon packet with a different MAC address and higher precedence than the current active ring supervisor.
- ▶ Loss of Beacon packets on both ports for the specified Beacon Timeout period. Losing the Beacon packets on both ports causes the participant to transition to IDLE\_STATE. The ring participant assumes that the topology has transitioned from a ring to a linear network.
- ▶ Loss of Beacon packets on a single port for the specified Beacon Timeout period.

In the cases listed above, the ring participant responds with the following actions:

- ▶ Flush the unicast MAC address table
- ▶ A loss of Beacon packets on both ports or the loss of Announce packets causes the ring participant to transition to the IDLE\_STATE.
- ▶ A loss of Beacon packets on a single port causes the ring participant to transition to the FAULT\_STATE.

### 13.5.3 Neighbor Check process

When the active ring supervisor detects the loss of Beacon packets, it sends a Locate\_Fault packet to the ring participants through both ports.

Upon receipt of the Locate\_Fault packet, each ring participant sends a Neighbor\_Check\_Request packet to its immediate neighbors. The supervisor also sends its own Neighbor\_Check\_Request to its immediate neighbors.

When the ring participant receives a Neighbor\_Check\_Request packet, it responds with a Neighbor\_Check\_Response packet on the port from which it received the request. When the participant sending the Neighbor\_Check\_Request does not receive a response, it sends another request. When the participant receives no responses after 3 attempts, it sends a Neighbor\_Status packet to the ring supervisor.

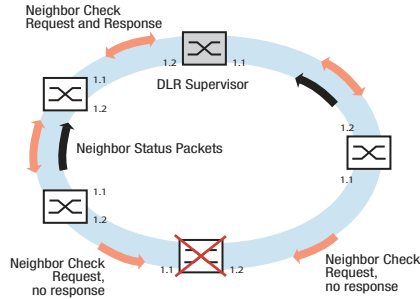

Figure 41: Neighbor Check process

### 13.5.4 Sign On Process

To identify ring participants, the active ring supervisor sends Sign\_On packets after transiting to the NORMAL\_STATE. The active supervisor sends a Sign\_On packet once every minute while in the NORMAL\_STATE. When the active supervisor receives a Sign\_On packet that it previously sent, it discontinues sending Sign\_On packets. The device displays the ring participant list in the [Switching > L2-Redundancy > Statistics](#) dialog.

The active ring supervisor sends the multicast Sign\_On packets from the unblocked port. When a ring participant receives the Sign\_On packet, it forwards the packet to the CPU of the device only. The CPU add the addresses of the participant and sends the Sign\_On packet out of the port opposite from the receiving port.

The ring participants send the Sign\_On packet around the ring. Each participant processes the Sign\_On packet in similar manner. Eventually the Sign\_On packet returns to the active ring supervisor. The active supervisor verifies that it sent the Sign\_On packet. For this purpose the active supervisor checks the first entry in the ring participant list.

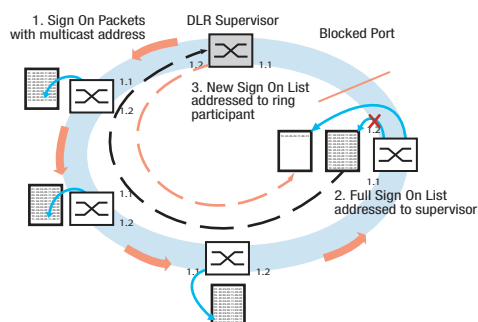

Figure 42: Sign On Process

If adding an address of a participant to the Sign\_On packet exceeds the maximum packet size, then the participant does not add its address to the received packet. The participant saves the port on which it received the packet. Then the participant sends the Sign\_On packet directly to the unicast MAC address of the active ring supervisor.

When the ring supervisor receives the Sign\_On packet sent to its unicast MAC address, it assumes this is due to the Sign\_On packet size reaching its maximum capacity. The supervisor restarts the process by sending a new Sign\_On packet directly to the unicast MAC address of the participant from which it received the unicast Sign\_On packet.

Upon receiving the new Sign\_On packet from the active ring supervisor, the ring participant adds its address to the Sign\_On packet. The participant then sends the multicast Sign\_On packet on the ring port opposite from the port saved in memory.

### 13.5.5 Example Configuration

The Device Level Ring (DLR) protocol provides redundancy for Ethernet data in a ring topology. Using the DLR protocol you control and monitor Ethernet and IP devices.

#### EtherNet/IP Environments

If you use the *DLR* function in conjunction with Ethernet environments, then verify that the parameters are specified as follows:

- ▶ *DLR*:
  - The *DLR* function is enabled.
  - The ports *1/1* and *1/2* are specified as the *DLR* ring ports.
  - The *Supervisor active* function is active.
- ▶ *EtherNet/IP*:
  - The *EtherNet/IP* function is enabled.
  - The *Write access* function is active.
- ▶ *Spanning Tree*:
  - The *Spanning Tree* function is disabled.
- ▶ VLANs:
  - The *VLAN unaware mode* function is active.
- ▶ *IGMP Snooping*:
  - The *IGMP Snooping* function is enabled, and active on every port.
  - The *IGMP Snooping Querier* function is enabled.
  - The *Snooping Enhancements* on *DLR* ring ports are specified as *Static (S)* and *Forward all (F)*.

When you order the device using the hardware code *D*, the values of parameters listed above are specified as the default settings.

Configure the *DLR* operation within an *EtherNet/IP* environment for example, with Rockwell or Allen-Bradley devices. To do this, perform the following steps:

- Open the *Switching > Global* dialog.
- In the *Configuration* frame, mark the *VLAN unaware mode* checkbox.
- Save the changes temporarily. To do this, click the  button.
- Open the *Switching > L2-Redundancy > DLR > Configuration* dialog.
- To add a table entry, click the  button.
- In the *Name* column, specify the value *DLR\_Ring\_1*.
- In the *VLAN ID* column, specify the value *0*.

- To activate the configuration, mark the checkbox in the *Active* column.
- To enable the function, select the *On* radio button in the *Operation* frame.
- Save the changes temporarily. To do this, click the  button.

```
enable
vlan database
vlan-unaware-mode
exit
configure
dlr ring add 1
dlr ring modify 1 name DLR_Ring_1

dlr ring modify 1 port-1 1/1
dlr ring modify 1 port-2 1/2
dlr ring modify 1 precedence 250

dlr ring modify 1 supervisor enable
dlr ring modify 1 vlan 0

dlr ring modify 1 operation enable
dlr operation
```

Change to the Privileged EXEC mode.

Change to the VLAN configuration mode.

Activate the *VLAN unaware mode* function.

Change to the Privileged EXEC mode.

Change to the Configuration mode.

Create the *DLR* ring 1.

Specify the value *DLR\_Ring\_1* as the name of the *DLR* ring.

Specify port *1/1* as the *DLR* ring port 1.

Specify port *1/2* as the *DLR* ring port 2.

Specify the value *250* as the supervisor precedence.

Enable the ring supervisor function.

Specify the value *0* as the VLAN identifier. The device uses the VLAN to forward the *DLR* protocol messages.

Enable the *DLR* function for ring 1.

Enable the global *DLR* function.



## 13.6 Spanning Tree

**Note:** The Spanning Tree Protocol is a protocol for MAC bridges. For this reason, the following description uses the term bridge for the device.

Local networks are getting bigger and bigger. This applies to both the geographical expansion and the number of network participants. Therefore, it is advantageous to use multiple bridges, for example:

- ▶ to reduce the network load in sub-areas,
- ▶ to set up redundant connections and
- ▶ to overcome distance limitations.

However, using multiple bridges with multiple redundant connections between the subnetworks can lead to loops and thus interruption of communication across the network. In order to help avoid this, you can use Spanning Tree. Spanning Tree enables loop-free switching through the systematic deactivation of redundant connections. Redundancy enables the systematic reactivation of individual connections as needed.

RSTP is a further development of the Spanning Tree Protocol (STP) and is compatible with it. When a connection or a bridge becomes inoperable, the STP requires a maximum of 30 seconds to reconfigure. This is no longer acceptable in time-sensitive applications. RSTP achieves average reconfiguration times of less than a second. When you use RSTP in a ring topology with 10 to 20 devices, you can even achieve reconfiguration times in the order of milliseconds.

**Note:** RSTP reduces a layer 2 network topology with redundant paths into a tree structure (Spanning Tree) that does not contain any more redundant paths. One of the devices takes over the role of the root bridge here. The maximum number of devices permitted in an active branch (from the root bridge to the tip of the branch) is specified by the variable *Max age* for the current root bridge. The preset value for *Max age* is 20, which can be increased up to 40.

If the device working as the root is inoperable and another device takes over its function, then the *Max age* setting of the new root bridge determines the maximum number of devices allowed in a branch.

**Note:** The RSTP standard requires that every device within a network operates with the (Rapid) Spanning Tree Algorithm. When STP and RSTP are used at the same time, the advantages of faster reconfiguration with RSTP are lost in the network segments that are operated in combination.

A device that only supports RSTP works together with MSTP devices by not assigning an MST region to itself, but rather the CST (Common Spanning Tree).

### 13.6.1 Basics

Because RSTP is a further development of the STP, every of the following descriptions of the STP also apply to RSTP.

## The tasks of the STP

The Spanning Tree Algorithm reduces network topologies built with bridges and containing ring structures due to redundant links to a tree structure. In doing so, STP opens ring structures according to preset rules by deactivating redundant paths. When a path is interrupted because a network component becomes inoperable, STP reactivates the previously deactivated path again. This lets redundant links increase the availability of communication.

STP determines a bridge that represents the STP tree structure's base. This bridge is called root bridge.

Features of the STP algorithm:

- ▶ automatic reconfiguration of the tree structure in the case of a bridge becoming inoperable or the interruption of a data path
- ▶ the tree structure is stabilized up to the maximum network size,
- ▶ stabilization of the topology within a short time period
- ▶ topology can be specified and reproduced by the administrator
- ▶ transparency for the end devices
- ▶ low network load relative to the available transmission capacity due to the tree structure created

## Bridge parameters

In the context of Spanning Tree, each bridge and its connections are uniquely described by the following parameters:

- ▶ Bridge Identifier
- ▶ Root Path Cost for the bridge ports,
- ▶ Port Identifier

## Bridge Identifier

The Bridge Identifier consists of 8 bytes. The 2 highest-value bytes are the priority. When configuring the network, the Management Administrator can change the default setting for the priority number which is 32768. The 6 lowest-value bytes of the bridge identifier are the bridge's MAC address. The MAC address lets each bridge have unique bridge identifiers.

The bridge with the smallest number for the bridge identifier has the highest priority.



Figure 43: Bridge Identifier, Example (values in hexadecimal notation)

## Root Path Cost

Each path that connects 2 bridges is assigned a cost for the transmission (path cost). The device determines this value based on the transmission speed (see table 29). The device assigns a higher path cost to paths with lower transmission speeds.

Alternatively, the Administrator can set the path cost. Like the device, the Administrator assigns a higher path cost to paths with lower transmission speeds. However, since the Administrator can choose this value freely, he has a tool with which he can give a certain path an advantage among redundant paths.

The root path cost is the sum of the individual costs of those paths that a data packet has to traverse from a connected bridge's port to the root bridge.

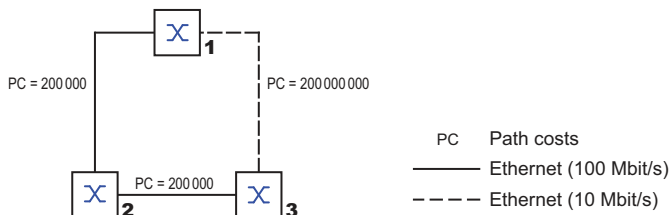

Figure 44: Path costs

Table 29: Recommended path costs for RSTP based on the data rate.

Data rate	Recommended value	Recommended range	Possible range
≤100 kbit/s	200 000 000 <sup>1</sup>	20 000 000-200 000 000	1-200 000 000
1 Mbit/s	20 000 000 <sup>a</sup>	2 000 000-200 000 000	1-200 000 000
10 Mbit/s	2 000 000 <sup>a</sup>	200 000-20 000 000	1-200 000 000
100 Mbit/s	200 000 <sup>a</sup>	20 000-2 000 000	1-200 000 000
1 Gbit/s	20 000	2 000-200 000	1-200 000 000
10 Gbit/s	2 000	200-20 000	1-200 000 000
100 Gbit/s	200	20-2 000	1-200 000 000
1 TBit/s	20	2-200	1-200 000 000
10 TBit/s	2	1-20	1-200 000 000

1. Bridges that conform with IEEE 802.1D 1998 and only support 16-bit values for the path costs should use the value 65,535 (FFFFH) for path costs in cases where they are used in conjunction with bridges that support 32-bit values for the path costs.

### Port Identifier

The port identifier consists of 2 bytes. One part, the lower-value byte, contains the physical port number. This provides a unique identifier for the port of this bridge. The second, higher-value part is the port priority, which is specified by the Administrator (default value: 128). It also applies here that the port with the smallest number for the port identifier has the highest priority.

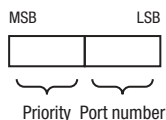

Figure 45: Port Identifier

### Max Age and Diameter

The “Max Age” and “Diameter” values largely determine the maximum expansion of a Spanning Tree network.

## Diameter

The number of connections between the devices in the network that are furthest removed from each other is known as the network diameter.

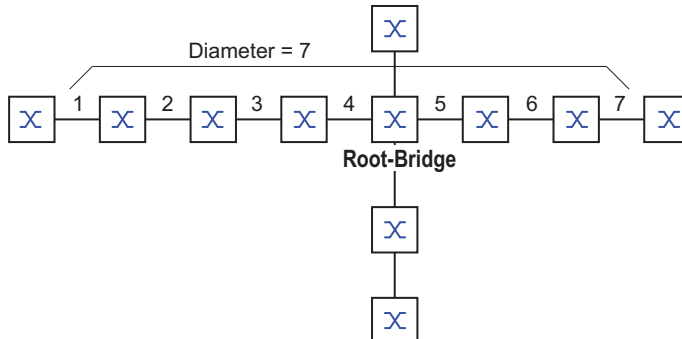

Figure 46: Definition of diameter

The network diameter that can be achieved in the network is  $\text{MaxAge}-1$ .

In the state on delivery,  $\text{MaxAge} = 20$  and the maximum diameter that can be achieved = 19. When you set the maximum value of 40 for  $\text{MaxAge}$ , the maximum diameter that can be achieved = 39.

## MaxAge

Every STP-BPDU contains a “MessageAge” counter. When a bridge is passed through, the counter increases by 1.

Before forwarding a STP-BPDU, the bridge compares the “MessageAge” counter with the “MaxAge” value specified in the device:

- When  $\text{MessageAge} < \text{MaxAge}$ , the bridge forwards the STP-BPDU to the next bridge.
- When  $\text{MessageAge} = \text{MaxAge}$ , the bridge discards the STP-BPDU.

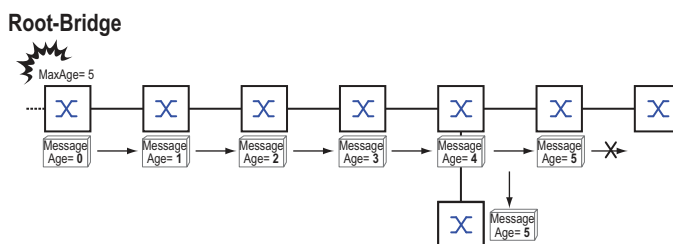

Figure 47: Transmission of an STP-BPDU depending on MaxAge

### 13.6.2 Rules for Creating the Tree Structure

#### Bridge information

To determine the tree structure, the bridges need more detailed information about the other bridges located in the network.

To obtain this information, each bridge sends a BPDU (Bridge Protocol Data Unit) to the other bridges.

The contents of a BPDU include:

- ▶ Bridge identifier
- ▶ Root path costs
- ▶ Port identifier

(see IEEE 802.1D)

## Setting up the tree structure

The bridge with the smallest number for the bridge identifier is called the root bridge. It is (or will become) the root of the tree structure.

The structure of the tree depends on the root path costs. Spanning Tree selects the structure so that the path costs between each individual bridge and the root bridge become as small as possible.

- ▶ When there are multiple paths with the same root path costs, the bridge further away from the root decides which port it blocks. For this purpose, it uses the bridge identifiers of the bridge closer to the root. The bridge blocks the port that leads to the bridge with the numerically higher ID (a numerically higher ID is the logically worse one). When 2 bridges have the same priority, the bridge with the numerically larger MAC address has the numerically higher ID, which is logically the worse one.
- ▶ When multiple paths with the same root path costs lead from one bridge to the same bridge, the bridge further away from the root uses the port identifier of the other bridge as the last criterion (see figure 45). In the process, the bridge blocks the port that leads to the port with the numerically higher ID (a numerically higher ID is the logically worse one). When 2 ports have the same priority, the port with the higher port number has the numerically higher ID, which is logically the worse one.

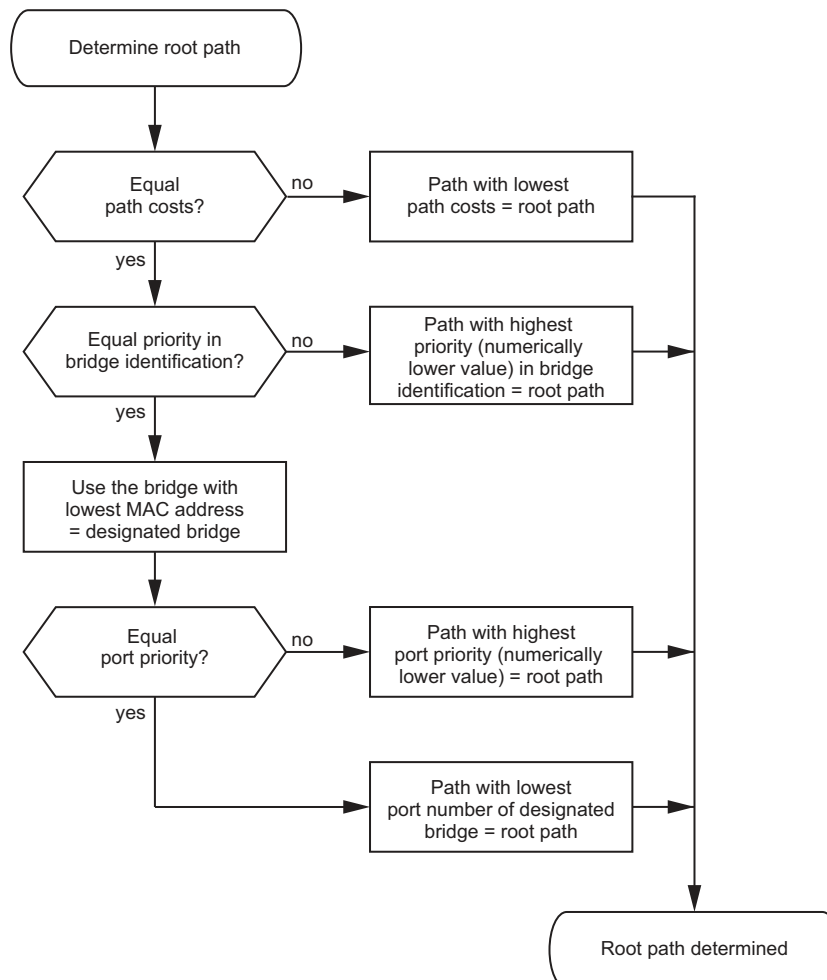

Figure 48: Flow diagram for specifying the root path

### 13.6.3 Examples

#### Example of determining the root path

You can use the network plan (see figure 49) to follow the flow chart (see figure 48) for determining the root path. The administrator has specified a priority in the bridge identification for each bridge. The bridge with the smallest numerical value for the bridge identification takes on the role of the root bridge, in this case, bridge 1. In the example every sub-path has the same path costs. The protocol blocks the path between bridge 2 and bridge 3 as a connection from bridge 3 via bridge 2 to the root bridge would result in higher path costs.

The path from bridge 6 to the root bridge is interesting:

- ▶ The path via bridge 5 and bridge 3 creates the same root path costs as the path via bridge 4 and bridge 2.
- ▶ STP selects the path using the bridge that has the lowest MAC address in the bridge identification (bridge 4 in the illustration).
- ▶ There are also 2 paths between bridge 6 and bridge 4. The port identifier is decisive here (Port 1 < Port 3).

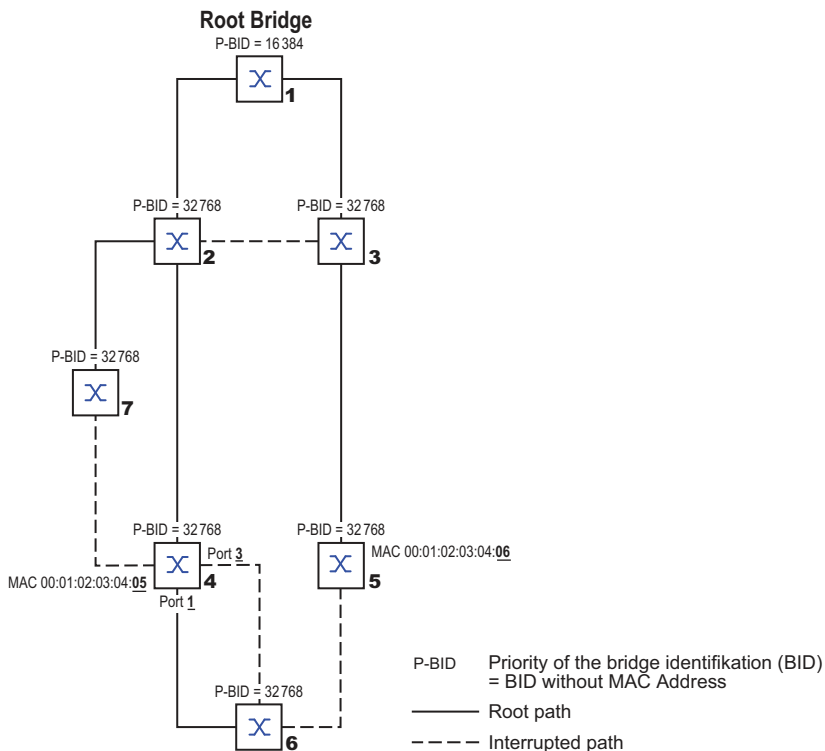

Figure 49: Example of determining the root path

**Note:** When the current root bridge goes down, the MAC address in the bridge identifier alone determines which bridge becomes the new root bridge, because the Administrator does not change the default values for the priorities of the bridges in the bridge identifier, apart from the value for the root bridge.

### Example of manipulating the root path

You can use the network plan (see figure 50) to follow the flow chart (see figure 48) for determining the root path. The Administrator has performed the following:

- Left the default value of 32768 (8000H) for every bridge apart from bridge 1 and bridge 5, and
- assigned to bridge 1 the value 16384 (4000H), thus making it the root bridge.
- To bridge 5 he assigned the value 28672 (7000H).

The protocol blocks the path between bridge 2 and bridge 3 as a connection from bridge 3 via bridge 2 to the root bridge would mean higher path costs.

The path from bridge 6 to the root bridge is interesting:

- The bridges select the path via bridge 5 because the value 28672 for the priority in the bridge identifier is smaller than value 32768.

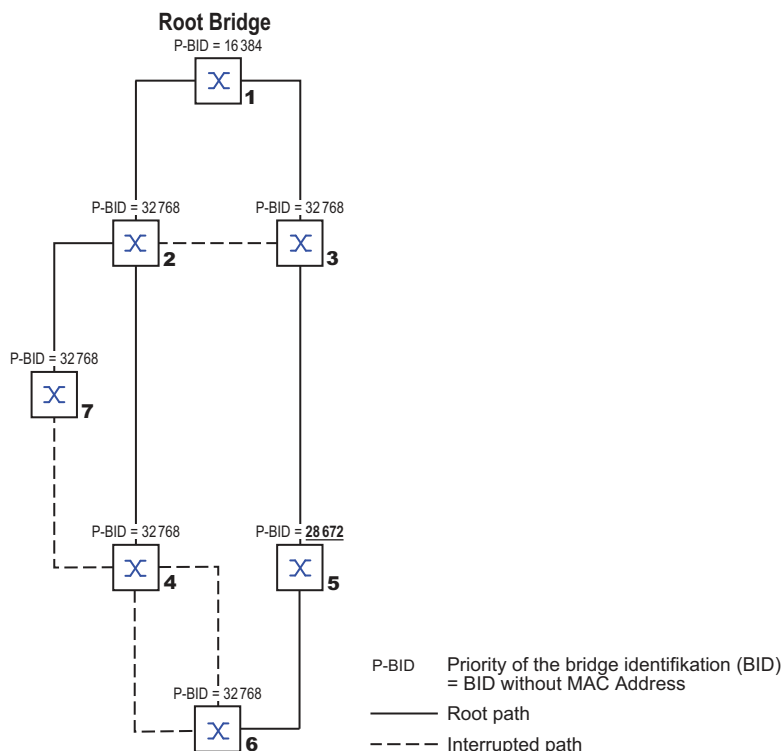

Figure 50: Example of manipulating the root path



### Example of manipulating the tree structure

The Management Administrator soon discovers that this configuration with bridge 1 as the root bridge is invalid. On the paths from bridge 1 to bridge 2 and bridge 1 to bridge 3, the control packets which the root bridge sends to every other bridge add up.

When the Management Administrator configures bridge 2 as the root bridge, the burden of the control packets on the subnetworks is distributed much more evenly. The result is the configuration shown here (see figure 51). The path costs for most of the bridges to the root bridge have decreased.

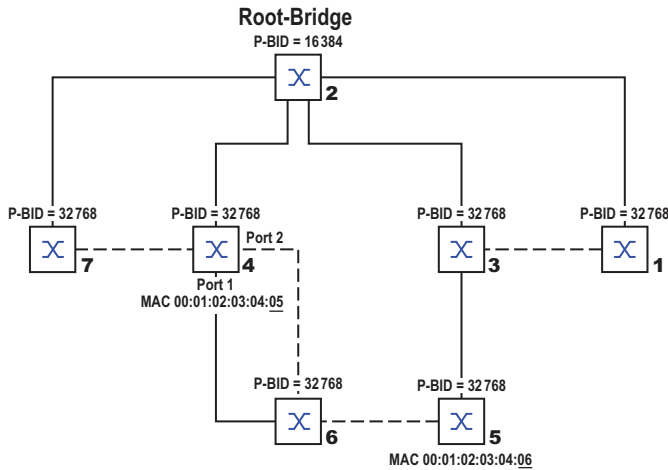

P-BID Priority of the bridge identification (BID)  
= BID without MAC Address

—— Root path

---- Interrupted path

Figure 51: Example of manipulating the tree structure

## 13.7 The Rapid Spanning Tree Protocol

The RSTP uses the same algorithm for determining the tree structure as STP. When a link or bridge becomes inoperable, RSTP merely changes parameters, and adds new parameters and mechanisms that speed up the reconfiguration.

The ports play a significant role in this context.

### 13.7.1 Port roles

RSTP assigns each bridge port one of the following roles (see figure 52):

- ▶ **Root Port:**  
This is the port at which a bridge receives data packets with the lowest path costs from the root bridge.  
When there are multiple ports with equally low path costs, the bridge ID of the bridge that leads to the root (designated bridge) decides which of its ports is given the role of the root port by the bridge further away from the root.  
When a bridge has multiple ports with equally low path costs to the same bridge, the bridge uses the port ID of the bridge leading to the root (designated bridge) to decide which port it selects locally as the root port (see figure 48).  
The root bridge itself does not have a root port.
- ▶ **Designated port:**  
The bridge in a network segment that has the lowest root path costs is the designated bridge. When more than one bridge has the same root path costs, the bridge with the smallest value bridge identifier becomes the designated bridge. The designated port on this bridge is the port that connects a network segment leading away from the root bridge. When a bridge is connected to a network segment with more than one port (via a hub, for example), the bridge gives the role of the designated port to the port with the better port ID.
- ▶ **Edge port**  
Every network segment with no additional RSTP bridges is connected with exactly one designated port. In this case, this designated port is also an edge port. The distinction of an edge port is the fact that it does not receive any RST BPDUs (Rapid Spanning Tree Bridge Protocol Data Units).
- ▶ **Alternate port**  
When the connection to the root bridge is lost, this blocked port takes over the task of the root port. The alternate port provides a backup for the connection to the root bridge.

- ▶ Backup port  
This is a blocked port that serves as a backup in case the connection to the designated port of this network segment (without any RSTP bridges) is lost
- ▶ Disabled port  
This is a port that does not participate in the Spanning Tree Operation, that means, the port is switched off or does not have any connection.

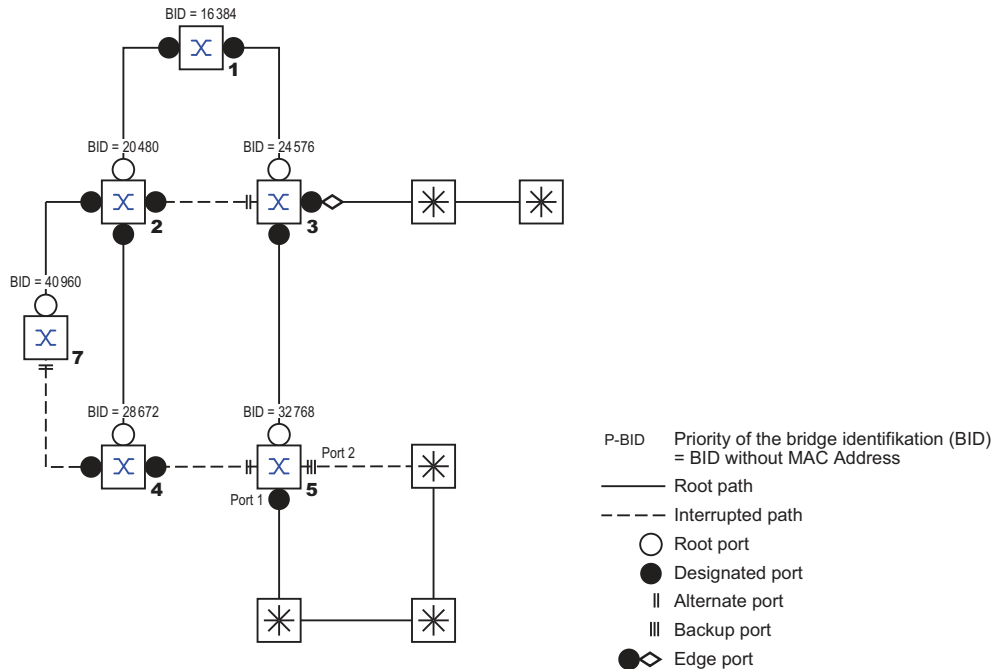

Figure 52: Port role assignment

### 13.7.2 Port states

Depending on the tree structure and the state of the selected connection paths, the RSTP assigns the ports their states.

Table 30: Relationship between port state values for STP and RSTP

STP port state	Administrative bridge port state	MAC Operational	RSTP Port state	Active topology (port role)
DISABLED	Disabled	FALSE	Discarding <sup>1</sup>	Excluded (disabled)
DISABLED	Enabled	FALSE	Discarding <sup>a</sup>	Excluded (disabled)
BLOCKING	Enabled	TRUE	Discarding <sup>2</sup>	Excluded (alternate, backup)
LISTENING	Enabled	TRUE	Discarding <sup>b</sup>	Included (root, designated)
LEARNING	Enabled	TRUE	Learning	Included (root, designated)
FORWARDING	Enabled	TRUE	Forwarding	Included (root, designated)

1. The dot1d-MIB displays "Disabled".  
2. The dot1d-MIB displays "Blocked".

Meaning of the RSTP port states:

- ▶ Disabled: Port does not belong to the active topology
- ▶ Discarding: No address learning in FDB, no data traffic except for STP-BPDUs

- ▶ Learning: Address learning active (FDB), no data traffic apart from STP-BPDUs
- ▶ Forwarding: Address learning active (FDB), sending and receiving of every packet type (not only STP-BPDUs)

### 13.7.3 Spanning Tree Priority Vector

To assign roles to the ports, the RSTP bridges exchange configuration information with each other. This information is known as the Spanning Tree Priority Vector. It is part of the RSTP BPDUs and contains the following information:

- ▶ Bridge identification of the root bridge
- ▶ Root path costs of the sending bridge
- ▶ Bridge identification of the sending bridge
- ▶ Port identifiers of the ports through which the message was sent
- ▶ Port identifiers of the ports through which the message was received

Based on this information, the bridges participating in RSTP are able to determine port roles themselves and define the port states of their own ports.

### 13.7.4 Fast reconfiguration

Why can RSTP react faster than STP to an interruption of the root path?

- ▶ Introduction of edge-ports:  
During a reconfiguration, RSTP sets an edge port into the transmission mode after 3 seconds (default setting). To ascertain that no bridge sending BPDUs is connected, RSTP waits for the “Hello Time” to elapse.  
When you verify that an end device is and remains connected to this port, there are no waiting times at this port in the case of a reconfiguration.
- ▶ Introduction of alternate ports:  
As the port roles are already distributed in normal operation, a bridge can immediately switch from the root port to the alternate port after the connection to the root bridge is lost.
- ▶ Communication with neighboring bridges (point-to-point connections):  
Decentralized, direct communication between neighboring bridges enables reaction without wait periods to status changes in the spanning tree topology.
- ▶ Address table:  
With STP, the age of the entries in the FDB determines the updating of communication. RSTP immediately deletes the entries in those ports affected by a reconfiguration.
- ▶ Reaction to events:  
Without having to adhere to any time specifications, RSTP immediately reacts to events such as connection interruptions, connection reinstatements, etc.

**Note:** Data packages could be duplicated and/or arrive at the recipient in the wrong order during the reconfiguration phase of the RSTP topology. You may also use the Spanning Tree Protocol or select another redundancy procedure described in this manual.

### 13.7.5 STP compatibility mode

The STP compatibility mode lets you operate RSTP devices in networks with old installations. If an RSTP device detects an older STP device, then it switches on the STP compatibility mode on the relevant port.

### 13.7.6 Configuring the device

RSTP configures the network topology completely autonomously. The device with the lowest bridge priority automatically becomes the root bridge. However, to define a specific network structure regardless, you specify a device as the root bridge. In general, a device in the backbone takes on this role.

Perform the following steps:

- Set up the network to meet your requirements, initially without redundant lines.
- You deactivate the flow control on the participating ports.  
If the flow control and the redundancy function are active at the same time, it is possible that the redundancy function operates differently than intended. (Default setting: flow control deactivated globally and activated on every port.)
- Disable MRP on every device.
- Enable Spanning Tree on every device in the network.  
In the state on delivery, Spanning Tree is switched on in the device.

Perform the following steps:

- Open the *Switching > L2-Redundancy > Spanning Tree > Global* dialog.
- Enable the function.
- Save the changes temporarily. To do this, click the  button.

<code>enable</code>	Change to the Privileged EXEC mode.
<code>configure</code>	Change to the Configuration mode.
<code>spanning-tree operation</code>	Enables Spanning Tree.
<code>show spanning-tree global</code>	Displays the parameters for checking.

Now connect the redundant lines.

Define the settings for the device that takes over the role of the root bridge.

Perform the following steps:

- In the *Priority* field you enter a numerically lower value.  
The bridge with the numerically lowest bridge ID has the highest priority and becomes the root bridge of the network.
- Save the changes temporarily. To do this, click the  button.

<code>spanning-tree mst priority 0 &lt;0..61440 in 4096er-Schritten&gt;</code>	Specifies the bridge priority of the device.
--	--

After saving, the dialog shows the following information:

- The *Bridge is root* checkbox is marked.
- The *Root port* field shows the value `0.0`.
- The *Root path cost* field shows the value `0`.

<code>show spanning-tree global</code>	Displays the parameters for checking.
--	---------------------------------------

- If applicable, then change the values in the *Forward delay [s]* and *Max age* fields.
  - The root bridge transmits the changed values to the other devices.
- Save the changes temporarily. To do this, click the  button.

<code>spanning-tree forward-time &lt;4..30&gt;</code>	Specifies the delay time for the status change in seconds.
<code>spanning-tree max-age &lt;6..40&gt;</code>	Specifies the maximum permissible branch length, for example the number of devices to the root bridge.
<code>show spanning-tree global</code>	Displays the parameters for checking.

**Note:** The parameters *Forward delay [s]* and *Max age* have the following relationship:

$$\textit{Forward delay [s]} \geq (\textit{Max age}/2) + 1$$

If you enter values in the fields that contradict this relationship, then the device replaces these values with the last valid values or with the default value.

**Note:** When possible, do not change the value in the “Hello Time” field.

Check the following values in the other devices:

- Bridge ID (bridge priority and MAC address) of the corresponding device and the root bridge.
- Number of the device port that leads to the root bridge.
- Path cost from the root port of the device to the root bridge.

Perform the following steps:

<code>show spanning-tree global</code>	Displays the parameters for checking.
--	---------------------------------------

### 13.7.7 Guards

The device lets you activate various protection functions (guards) in the device ports.

The following protection functions help protect your network from incorrect configurations, loops and attacks with STP-BPDUs:

- ▶ BPDU Guard – for manually specified edge ports (end device ports)  
You activate this protection function globally in the device.

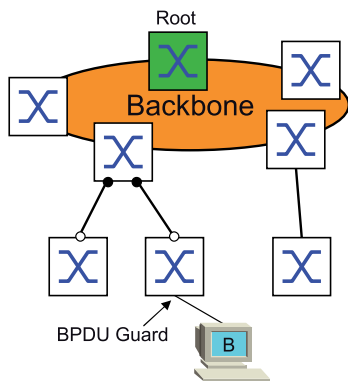

Terminal device ports do not normally receive any STP-BPDUs. If an attacker still attempts to feed in STP-BPDUs on this port, then the device deactivates the device port.

- ▶ Root Guard – for designated ports  
You activate this protection function separately for every device port.

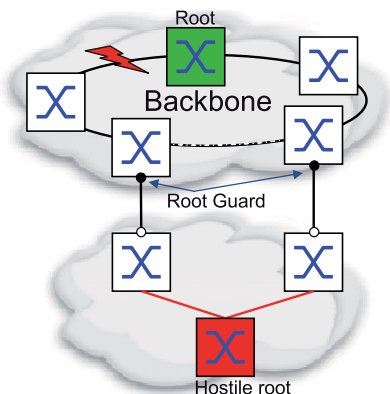

When a designated port receives an STP-BPDUs with better path information to the root bridge, the device discards the STP-BPDUs and sets the transmission state of the port to *discarding* instead of *root*.

When there are no STP-BPDUs with better path information to the root bridge, after  $2 \times \textit{Hello time [s]}$  the device resets the state of the port to a value according to the port role.

- ▶ TCN Guard – for ports that receive STP-BPDUs with a Topology Change flag  
You activate this protection function separately for every device port.

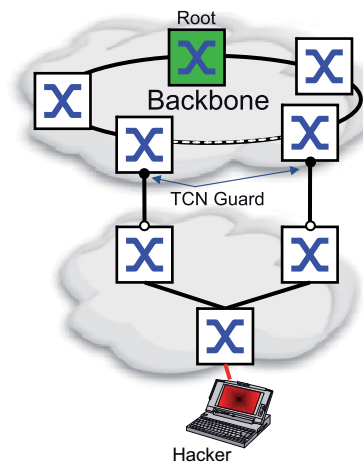

If the protection function is activated, then the device ignores Topology Change flags in received STP-BPDUs. This does not change the content of the address table (FDB) of the device port. However, additional information in the BPDU that changes the topology is processed by the device.

- ▶ Loop Guard – for root, alternate and backup ports  
You activate this protection function separately for every device port.

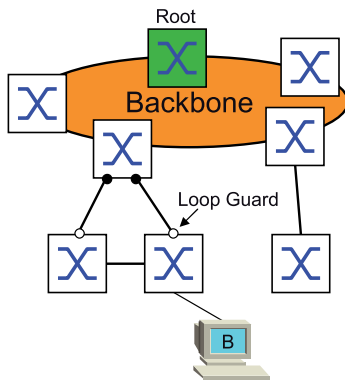

If the port does not receive any more STP-BPDUs, then this protection function helps prevent the transmission status of a port from unintentionally being changed to *forwarding*. If this situation occurs, then the device designates the loop status of the port as inconsistent, but does not forward any data packets.

### Activating the BPDU Guard

Perform the following steps:

- Open the *Switching > L2-Redundancy > Spanning Tree > Global* dialog.
- Mark the *BPDU guard* checkbox.
- Save the changes temporarily. To do this, click the  button.

enable

Change to the Privileged EXEC mode.



<pre>configure</pre>	Change to the Configuration mode.
<pre>spanning-tree bpduguard</pre>	Activates the BPDU Guard.
<pre>show spanning-tree global</pre>	Displays the parameters for checking.

- Open the *Switching > L2-Redundancy > Spanning Tree > Port* dialog.
- Switch to the *CIST* tab.
- For end device ports, mark the checkbox in the *Admin edge port* column.
- Save the changes temporarily. To do this, click the  button.

<pre>interface &lt;x/y&gt;</pre>	Change to the interface configuration mode of interface <x/y>.
<pre>spanning-tree edge-port</pre>	Designates the port as a terminal device port (edge port).
<pre>show spanning-tree port x/y</pre>	Displays the parameters for checking.
<pre>exit</pre>	Leaves the interface mode.

When an edge port receives an STP-BPDU, the device behaves as follows:

- ▶ The device deactivates this port.  
In the *Basic Settings > Port* dialog, *Configuration* tab, the checkbox for this port in the *Port on* column is *unmarked*.
- ▶ The device designates the port.

You can determine if a port has disabled itself because of a received a BPDU. To do this, perform the following steps:

In the *Switching > L2-Redundancy > Spanning Tree > Port* dialog, *Guards* tab, the checkbox in the *BPDU guard effect* column is *marked*.

<pre>show spanning-tree port x/y</pre>	Displays the parameters of the port for checking. The value of the <i>BPDU guard effect</i> parameter is <i>enabled</i> .
--	---

Reset the status of the device port to the value *forwarding*. To do this, perform the following steps:

- When the port still receives BPDUs:
  - Remove the manual definition as an edge port (end device port).
  - or
  - Deactivate the BPDU Guard.
- Activate the device port again.

## Activating Root Guard / TCN Guard / Loop Guard

Perform the following steps:

- Open the *Switching > L2-Redundancy > Spanning Tree > Port* dialog.
- Switch to the *Guards* tab.
- For designated ports, select the checkbox in the *Root guard* column.
- For ports that receive STP-BPDUs with a Topology Change flag, select the checkbox in the *TCN guard* column.
- For root, alternate or backup ports, mark the checkbox in the *Loop guard* column.

**Note:** The *Root guard* and *Loop guard* functions are mutually exclusive. If you try to activate the *Root guard* function while the *Loop guard* function is active, then the device deactivates the *Loop guard* function.

- Save the changes temporarily. To do this, click the  button.

enable	Change to the Privileged EXEC mode.
configure	Change to the Configuration mode.
interface <x/y>	Change to the interface configuration mode of interface <x/y>.
spanning-tree guard-root	Switches the Root Guard on at the designated port.
spanning-tree guard-tcn	Switches the TCN Guard on at the port that receives STP-BPDUs with a Topology Change flag.
spanning-tree guard-loop	Switches the Loop Guard on at a root, alternate or backup port.
exit	Leaves the interface mode.
show spanning-tree port x/y	Displays the parameters of the port for checking.

### 13.7.8 RSTP over HSR

The RSTP over HSR function lets you redundantly couple an RSTP network to an HSR ring.

By doing this:

- ▶ The device uses the logical port *hsr/1*.
- ▶ When the logical port *hsr/1* changes from the RSTP state to 'forwarding', the device flushes the Proxy Node Table.

#### Configuring RSTP over HSR

HSR limits the bandwidth. In case of redundancy, RSTP is configured in a way that the traffic is forwarded over the HSR ring only.

### Example

You use the RSTP over HSR function to redundantly couple an RSTP network to an HSR ring.

Perform the following steps:

- Open the *Switching > L2-Redundancy > Spanning Tree > Port* dialog.
- In the *Port priority* column, specify the value `240` for port `hSr/1`.
- In the *Port path cost* column, specify the value `200000000` for port `hSr/1`.
- Enable the *Spanning Tree* function on port `hSr/1`.  
In the *STP active* column, mark the checkbox for port `hSr/1`.

## 13.8 Link Aggregation

The *Link Aggregation* function using the single switch method helps you overcome 2 limitations with Ethernet links, namely bandwidth, and redundancy.

The *Link Aggregation* function helps you overcome bandwidth limitations of individual ports. The *Link Aggregation* function lets you combine 2 or more links in parallel, creating 1 logical link between 2 devices. The parallel links increase the bandwidth for traffic between the 2 devices.

You typically use the *Link Aggregation* function on the network backbone. The function provides you an inexpensive way to incrementally increase bandwidth.

Furthermore, the *Link Aggregation* function provides for redundancy with a seamless failover. When a link goes down, with 2 or more links configured in parallel, the other links in the group continue to forward traffic.

The device uses a hash option to determine load balancing across the port group. Tagging the egress traffic lets the device transmit associated packets across the same link.

The default settings for a new *Link Aggregation* instance are as follows:

- ▶ In the *Configuration* frame, the value in the *Hashing option* field is `sourceDestMacVlan`.
- ▶ In the *Active* column, the checkbox is marked.
- ▶ In the *Send trap (Link up/down)* column, the checkbox is marked.
- ▶ In the *Static link aggregation* column, the checkbox is unmarked.
- ▶ In the *Hashing option* column, the value is `sourceDestMacVlan`.
- ▶ In the *Active ports (min.)* column, the value is 1.

### 13.8.1 Methods of Operation

The device operates on the Single Switch method. The Single Switch method provides you an inexpensive way to grow your network. The single switch method states that you need one device on each side of a link to provide the physical ports. The device balances the traffic load across the group member ports.

The device also uses the Same Link Speed method in which the group member ports are full-duplex, point-to-point links having the same transmission rate. The first port that you add to the group is the master port and determines the bandwidth for the other member ports of the Link Aggregation Group.

The device lets you set up up to 2 Link Aggregation groups. The number of useable ports per Link Aggregation group depends on the device.

#### Hash Algorithm

The frame distributor is responsible for receiving frames from the end devices and transmitting them over the Link Aggregation Group. The frame distributor implements a distribution algorithm responsible for choosing the link used for transmitting any given packet. The hash option helps you achieve load balancing across the group.

The following list contains options which you set for link selection.

- ▶ Source MAC address, VLAN ID, EtherType, and receiving port
- ▶ Destination MAC address, VLAN ID, EtherType, and receiving port

- ▶ Source/Destination MAC address, VLAN ID, EtherType, and receiving port
- ▶ Source IP address and Source TCP/UDP port
- ▶ Destination IP address and destination TCP/UDP port
- ▶ Source/destination IP address and source/destination TCP/UDP port

### Static and Dynamic Links

The device lets you set up static and dynamic links.

- ▶ **Static Links** - The administrator sets up and maintains the links manually. For example, when a link fails and there is a media converter between the devices, the media converter continues forwarding traffic on the link causing the link to fail. Another possibility is that cabling or an undetected configuration mistake causes undesirable network behavior. In this case, the network administrator manually changes the link setup to restore traffic.
- ▶ **Dynamic Links** - The device confirms that the setup on the remote device is able to handle link aggregation and failover occurs automatically.

### 13.8.2 Link Aggregation Example

Connect multiple workstations using one aggregated link group between Switch 1 and 2. By aggregating multiple links, higher speeds are achievable without a hardware upgrade.

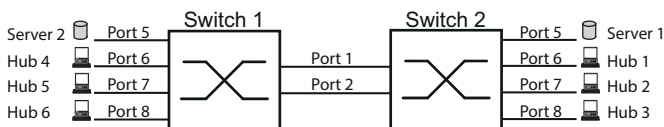

Figure 53: Link Aggregation Switch to Switch Network

Configure Switch 1 and 2 in the Graphical User Interface. To do this, perform the following steps:

- Open the [Switching > L2-Redundancy > Link Aggregation](#) dialog.
- Click the button.  
The dialog displays the [Create](#) window.
- In the [Trunk port](#) drop-down list, select the instance number of the link aggregation group.
- In the [Port](#) drop-down list, select port 1/1.
- Click the [Ok](#) button.
- Repeat the preceding steps and select the port 1/2.
- Click the [Ok](#) button.
- Save the changes temporarily. To do this, click the button.

enable	Change to the Privileged EXEC mode.
configure	Change to the Configuration mode.
link-aggregation add lag/1	Creates a Link Aggregation Group <code>lag/1</code> .
link-aggregation modify lag/1 addport 1/1	Adds port 1/1 to the Link Aggregation Group.
link-aggregation modify lag/1 addport 1/2	Adds port 1/2 to the Link Aggregation Group.

## 13.9 Link Backup

Link Backup provides a redundant link for traffic on Layer 2 devices. When the device detects an error on the primary link, the device transfers traffic to the backup link. You typically use Link Backup in service-provider or enterprise networks.

You set up the backup links in pairs, one as a primary and one as a backup. When providing redundancy for enterprise networks for example, the device lets you set up more than one pair. The maximum number of link backup pairs is: total number of physical ports / 2. Furthermore, when the state of a port participating in a link backup pair changes, the device sends an SNMP trap.

When configuring link backup pairs, remember the following rules:

- ▶ A link pair consists of any combination of physical ports. For example, one port is a 100 Mbit port and the other is a 1000 Mbit SFP port.
- ▶ A specific port is a member of one link backup pair at any given time.
- ▶ Verify that the ports of a link backup pair are members of the same VLAN with the same VLAN ID. When the primary port or backup port is a member of a VLAN, assign the second port of the pair to the same VLAN.

The default setting for this function is inactive without any link backup pairs.

**Note:** Verify that the Spanning Tree Protocol is disabled on the Link Backup ports.

### 13.9.1 Fail Back Description

Link Backup also lets you set up a Fail Back option. When you activate the fail back function and the primary link returns to normal operation, the device first blocks traffic on the backup port and then forwards traffic on the primary port. This process helps protect the device from causing loops in the network.

When the primary port returns to the link up and active state, the device supports 2 modes of operation:

- ▶ When you inactivate *Fail back*, the primary port remains in the blocking state until the backup link fails.
- ▶ When you activate *Fail back*, and after the *Fail back delay [s]* timer expires, the primary port returns to the forwarding state and the backup port changes to down.

In the cases listed above, the port forcing its link to forward traffic, first sends a "flush FDB" packet to the remote device. The flush packet helps the remote device quickly relearn the MAC addresses.

### 13.9.2 Example Configuration

In the example network below, you connect ports 2/3 and 2/4 on Switch A to the uplink Switches B and C. When you set up the ports as a Link Backup pair, one of the ports forwards traffic and the other port is in the blocking mode.

The primary, port 2/3 on Switch A, is the active port and is forwarding traffic to port 1 on Switch B. Port 2/4 on Switch A is the backup port and is blocking traffic.

When Switch A disables port 2/3 because of a detected error, port 2/4 on Switch A starts forwarding traffic to port 2 on Switch C.

When port 2/3 returns to the active state, “no shutdown”, with *Fail back* activated, and *Fail back delay [s]* set to 30 seconds. After the timer expires, port 2/4 first blocks the traffic and then port 2/3 starts forwarding the traffic.

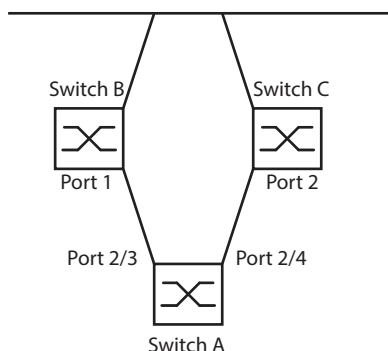



Figure 54: *Link Backup* example network

The following tables contain examples of parameters to configure Switch A.

Perform the following steps:

- Open the *Switching > L2-Redundancy > Link Backup* dialog.
- Enter a new Link Backup pair in the table:
  - Click the  button. The dialog displays the *Create* window.
  - In the *Primary port* drop-down list, select port 2/3. In the *Backup port* drop-down list, select port 2/4.
  - Click the *Ok* button.
- In the *Description* textbox, enter `Link_Backup_1` as the name for the backup pair.
- To activate the *Fail back* function for the link backup pair, mark the *Fail back* checkbox.
- Set the fail back timer for the link backup pair, enter 30 s in *Fail back delay [s]*.
- To activate the link backup pair, mark the *Active* checkbox.
- To enable the function, select the *On* radio button in the *Operation* frame.

<code>enable</code>	Change to the Privileged EXEC mode.
<code>configure</code>	Change to the Configuration mode.
<code>interface 2/3</code>	Change to the interface configuration mode of interface 2/3.
<code>link-backup add 2/4</code>	Creates a Link Backup instance where port 2/3 is the primary port and port 2/4 is the backup port.
<code>link-backup modify 2/4 description Link_Backup_1</code>	Specifies the string <code>Link_Backup_1</code> as the name of the backup pair.
<code>link-backup modify 2/4 failback-status enable</code>	Enable the fail back timer.
<code>link-backup modify 2/4 failback-time 30</code>	Specify the fail back delay time as 30 s.
<code>link-backup modify 2/4 status enable</code>	Enable the Link Backup instance.
<code>exit</code>	Change to the Configuration mode.
<code>link-backup operation</code>	Enable the <i>Link Backup</i> function globally in the device.

## 14 Operation diagnosis

The device provides you with the following diagnostic tools:

- ▶ Sending SNMP traps
- ▶ Monitoring the Device Status
- ▶ Out-of-Band signaling using the signal contact
- ▶ Port status indication
- ▶ Event counter at port level
- ▶ Detecting non-matching duplex modes
- ▶ Auto-Disable
- ▶ Displaying the SFP status
- ▶ Topology discovery
- ▶ Detecting IP address conflicts
- ▶ Detecting loops
- ▶ Reports
- ▶ Monitoring data traffic on a port (port mirroring)
- ▶ Syslog
- ▶ Event log
- ▶ Cause and action management during selftest

### 14.1 Sending SNMP traps

The device immediately reports unusual events which occur during normal operation to the network management station. This is done by messages called SNMP traps that bypass the polling procedure ("polling" means querying the data stations at regular intervals). SNMP traps allow you to react quickly to unusual events.

Examples of such events are:

- ▶ Hardware reset
- ▶ Changes to the configuration
- ▶ Segmentation of a port

The device sends SNMP traps to various hosts to increase the transmission reliability for the messages. The unacknowledged SNMP trap message consists of a packet containing information about an unusual event.

The device sends SNMP traps to those hosts entered in the trap destination table. The device lets you configure the trap destination table with the network management station using SNMP.



### 14.1.1 List of SNMP traps

The following table displays possible SNMP traps sent by the device.

Table 31: Possible SNMP traps

Name of the SNMP trap	Meaning
authenticationFailure	When a station attempts to access an agent without authorisation, this trap is sent.
coldStart	Sent after a restart.
hm2DevMonSenseExtNvmRemoval	When the external memory has been removed, this trap is sent.
linkDown	When the connection to a port is interrupted, this trap is sent.
linkUp	When connection is established to a port, this trap is sent.
hm2DevMonSensePSState	When the status of a power supply unit changes, this trap is sent.
hm2SigConStateChange	When the status of the signal contact changes in the operation monitoring, this trap is sent.
newRoot	When the sending agent becomes the new root of the spanning tree, this trap is sent.
topologyChange	When the port changes from <code>blocking</code> to <code>forwarding</code> or from <code>forwarding</code> to <code>blocking</code> , this trap is sent.
alarmRisingThreshold	When the RMON input exceeds its upper threshold, this trap is sent.
alarmFallingThreshold	When the RMON input goes below its lower threshold, this trap is sent.
hm2AgentPortSecurityViolation	When a MAC address detected on this port does not match the current settings of the parameter <code>hm2AgentPortSecurityEntry</code> , this trap is sent.
hm2DiagSelftestActionTrap	When a self test for the four categories “task”, “resource”, “software”, and “hardware” is performed according to the configured settings, this trap is sent.
hm2MrpReconfig	When the configuration of the MRP ring changes, this trap is sent.
hm2DiagIfaceUtilizationTrap	When the threshold of the interface exceeds or undercuts the upper or lower threshold specified, this trap is sent.
hm2LogAuditStartNextSector	When the audit trail after completing one sector starts a new one, this trap is sent.
hm2PtpSynchronizationChange	When the status of the PTP synchronization has been changed, this trap is sent.
hm2ConfigurationSavedTrap	After the device has successfully saved its configuration locally, this trap is sent.
hm2ConfigurationChangedTrap	When you change the configuration of the device for the first time after it has been saved locally, this trap is sent.
hm2PlatformStpInstanceLoopInconsistentStartTrap	When the port in this STP instance changes to the “loop inconsistent” status, this trap is sent.
hm2PlatformStpInstanceLoopInconsistentEndTrap	When the port in this STP instance leaves the “loop inconsistent” status receiving a BPDU packet, this trap is sent.

## 14.1.2 SNMP traps for configuration activity



After you save a configuration in the memory, the device sends a [hm2ConfigurationSavedTrap](#). This SNMP trap contains both the state variables of non-volatile memory (*NVM*) and external memory (*ENVM*) indicating if the running configuration is in sync with the non-volatile memory, and with the external memory. You can also trigger this SNMP trap by copying a configuration file to the device, replacing the active saved configuration.

Furthermore, the device sends a [hm2ConfigurationChangedTrap](#), whenever you change the local configuration, indicating a mismatch between the running and saved configuration.

## 14.1.3 SNMP trap setting

The device lets you send an SNMP trap as a reaction to specific events. Create at least one trap destination that receives SNMP traps.

Perform the following steps:

- Open the [Diagnostics > Status Configuration > Alarms \(Traps\)](#) dialog.
- Click the  button.  
The dialog displays the [Create](#) window.
- In the [Name](#) frame, specify the name that the device uses to identify itself as the source of the SNMP trap.
- In the [Address](#) frame, specify the IP address of the trap destination to which the device sends the SNMP traps.
- In the [Active](#) column you select the entries that the device should take into account when it sends SNMP traps.
- Save the changes temporarily. To do this, click the  button.

For example, in the following dialogs you specify when the device triggers an SNMP trap:

- ▶ [Basic Settings > Port](#) dialog
- ▶ [Basic Settings > Power over Ethernet > Global](#) dialog
- ▶ [Network Security > Port Security](#) dialog
- ▶ [Switching > L2-Redundancy > Link Aggregation](#) dialog
- ▶ [Diagnostics > Status Configuration > Device Status](#) dialog
- ▶ [Diagnostics > Status Configuration > Security Status](#) dialog
- ▶ [Diagnostics > Status Configuration > Signal Contact](#) dialog
- ▶ [Diagnostics > Status Configuration > MAC Notification](#) dialog
- ▶ [Diagnostics > System > IP Address Conflict Detection](#) dialog
- ▶ [Diagnostics > System > Selftest](#) dialog
- ▶ [Diagnostics > Ports > Port Monitor](#) dialog

## 14.1.4 ICMP messaging

The device lets you use the Internet Control Message Protocol (ICMP) for diagnostic applications, for example ping and trace route. The device also uses ICMP for time-to-live and discarding messages in which the device forwards an ICMP message back to the packet source device.

Use the ping network tool to test the path to a particular host across an IP network. The traceroute diagnostic tool displays paths and transit delays of packets across a network.

## 14.2 Monitoring the Device Status

The device status provides an overview of the overall condition of the device. Many process visualization systems record the device status for a device in order to present its condition in graphic form.

The device displays its current status as *error* or *ok* in the *Device status* frame. The device determines this status from the individual monitoring results.

The device enables you to:

- ▶ Out-of-Band signalling using a signal contact
- ▶ signal the changed device status by sending an SNMP trap
- ▶ detect the device status in the *Basic Settings > System* dialog of the Graphical User Interface
- ▶ query the device status in the Command Line Interface

The *Global* tab of the *Diagnostics > Status Configuration > Device Status* dialog lets you configure the device to send a trap to the management station for the following events:

- ▶ Incorrect supply voltage
  - at least one of the 2 supply voltages is not operating
  - the internal supply voltage is not operating
- ▶ When the device is operating outside of the user-defined temperature threshold
- ▶ Loss of the redundancy (in ring manager mode)
- ▶ The interruption of link connection(s)  
Configure at least one port for this feature. When the link is down, you specify which ports the device signals in the *Port* tab of the *Diagnostics > Status Configuration > Device Status* dialog in the *Propagate connection error* row.
- ▶ The removal of the external memory.
- ▶ The configuration in the external memory is out-of-sync with the configuration in the device.
- ▶ The removal of a module

Select the corresponding entries to decide which events the device status includes.

**Note:** With a non-redundant voltage supply, the device reports the absence of a supply voltage. To disable this message, feed the supply voltage over both inputs or ignore the monitoring.

### 14.2.1 Events which can be monitored

Table 32: *Device Status* events

Name	Meaning
<i>Temperature</i>	Monitors in case the temperature exceeds or falls below the value specified.
<i>Ring redundancy</i>	When ring redundancy is present, enable this function.
<i>Connection errors</i>	Enable this function to monitor every port link event in which the <i>Propagate connection error</i> checkbox is active.
<i>Ethernet module removal</i>	Enable this global function to monitor the removal of a module. Also enable the individual module to monitor.
<i>External memory removal</i>	Enable this function to monitor the presence of an external storage device.
<i>External memory not in sync</i>	The device monitors synchronization between the device configuration and the configuration stored in the external memory ( <i>ENVM</i> ).
<i>Power supply</i>	Enable this function to monitor the power supply.

## 14.2.2 Configuring the Device Status

Perform the following steps:

- Open the *Diagnostics > Status Configuration > Device Status* dialog, *Global* tab.
- For the parameters to be monitored, mark the checkbox in the *Monitor* column.
- To send an SNMP trap to the management station, activate the *Send trap* function in the *Traps* frame.
- In the *Diagnostics > Status Configuration > Alarms (Traps)* dialog, create at least one trap destination that receives SNMP traps.
- Save the changes temporarily. To do this, click the  button.
- Open the *Basic Settings > System* dialog.
- To monitor the temperature, at the bottom of the *System data* frame, you specify the temperature thresholds.
- Save the changes temporarily. To do this, click the  button.

enable

configure

device-status trap

device-status monitor envm-not-in-sync

device-status monitor envm-removal

device-status monitor power-supply 1

device-status monitor ring-redundancy

Change to the Privileged EXEC mode.

Change to the Configuration mode.

When the device status changes, send an SNMP trap.

Monitors the configuration profiles in the device and in the external memory.

The *Device status* changes to *error* in the following situations:

- The configuration profile only exists in the device.
- The configuration profile in the device differs from the configuration profile in the external memory.

Monitors the active external memory. When you remove the active external memory from the device, the value in the *Device status* frame changes to *error*.

Monitors the power supply unit 1. When the device has a detected power supply fault, the value in the *Device status* frame changes to *error*.

Monitors the ring redundancy.

The *Device status* changes to *error* in the following situations:

- The redundancy function becomes active (loss of redundancy reserve).
- The device is a normal ring participant and detects an error in its settings.

device-status monitor temperature

Monitors the temperature in the device. When the temperature exceeds or falls below the specified limit, the value in the *Device status* frame changes to *error*.

device-status monitor module-removal

Monitors the modules. When you remove a module from the device, the value in the *Device status* frame changes to *error*.

device-status module 1

Monitors module 1. When you remove the module 1 from the device, the value in the *Device status* frame changes to *error*.

In order to enable the device to monitor an active link without a connection, first enable the global function, then enable the individual ports.

Perform the following steps:

- Open the *Diagnostics > Status Configuration > Device Status* dialog, *Global* tab.
- For the *Connection errors* parameter, mark the checkbox in the *Monitor* column.
- Open the *Diagnostics > Status Configuration > Device Status* dialog, *Port* tab.
- For the *Propagate connection error* parameter, mark the checkbox in the column of the ports to be monitored.
- Save the changes temporarily. To do this, click the  button.

enable

Change to the Privileged EXEC mode.

configure

Change to the Configuration mode.

device-status monitor link-failure

Monitors the ports/interfaces link. When the link interrupts on a monitored port/interface, the value in the *Device status* frame changes to *error*.

interface 1/1

Change to the interface configuration mode of interface 1/1.

device-status link-alarm

Monitors the port/interface link. When the link interrupts on the port/interface, the value in the *Device status* frame changes to *error*.

**Note:** The above commands activate monitoring and trapping for the supported components. When you want to activate or deactivate monitoring for individual components, you will find the corresponding syntax in the “Command Line Interface” reference manual or in the help of the Command Line Interface console. To display the help in Command Line Interface, insert a question mark ? and press the <Enter> key.

### 14.2.3 Displaying the Device Status

Perform the following steps:

- Open the *Basic Settings > System* dialog.



```
show device-status all
```

In the EXEC Privilege mode: Displays the device status and the setting for the device status determination.

## 14.3 Security Status

The Security Status provides an overview of the overall security of the device. Many processes aid in system visualization by recording the security status of the device and then presenting its condition in graphic form. The device displays the overall security status in the [Basic Settings > System](#) dialog, [Security status](#) frame.

In the [Global](#) tab of the [Diagnostics > Status Configuration > Security Status](#) dialog the device displays its current status as *error* or *ok* in the [Security status](#) frame. The device determines this status from the individual monitoring results.

The device enables you to:

- ▶ Out-of-Band signalling using a signal contact
- ▶ signal the changed security status by sending an SNMP trap
- ▶ detect the security status in the [Basic Settings > System](#) dialog of the Graphical User Interface
- ▶ query the security status in the Command Line Interface

### 14.3.1 Events which can be monitored

Perform the following steps:

- Specify the events that the device monitors.
- For the corresponding parameter, mark the checkbox in the [Monitor](#) column.

Table 33: [Security Status events](#)

Name	Meaning
<a href="#">Password default settings unchanged</a>	After installation change the passwords to increase security. When active and the default passwords remain unchanged, the device displays an alarm.
<a href="#">Min. password length &lt; 8</a>	Create passwords more than 8 characters long to maintain a high security posture. When active, the device monitors the <a href="#">Min. password length</a> setting.
<a href="#">Password policy settings deactivated</a>	The device monitors the settings located in the <a href="#">Device Security &gt; User Management</a> dialog for password policy requirements.
<a href="#">User account password policy check deactivated</a>	The device monitors the settings of the <a href="#">Policy check</a> checkbox. When <a href="#">Policy check</a> is inactive, the device sends an SNMP trap.
<a href="#">Telnet server active</a>	The device monitors when you enable the <a href="#">Telnet</a> function.
<a href="#">HTTP server active</a>	The device monitors when you enable the <a href="#">HTTP</a> function.
<a href="#">SNMP unencrypted</a>	The device monitors when you enable the <a href="#">SNMPv1</a> or <a href="#">SNMPv2</a> function.
<a href="#">Access to system monitor with serial interface possible</a>	The device monitors the System Monitor status.
<a href="#">Saving the configuration profile on the external memory possible</a>	The device monitors the possibility to save configurations to the external non-volatile memory.
<a href="#">Link interrupted on enabled device ports</a>	The device monitors the link status of active ports.
<a href="#">Access with HiDiscovery possible</a>	The device monitors when you enable the HiDiscovery read/write access function.
<a href="#">Load unencrypted config from external memory</a>	The device monitors the security settings for loading the configuration from the external NVM.

Table 33: *Security Status events (cont.)*

Name	Meaning
<i>IEC61850-MMS active</i>	The device monitors the IEC 61850-MMS protocol activation setting.
<i>Modbus TCP active</i>	The device monitors the Modbus TCP/IP protocol activation setting.
<i>Self-signed HTTPS certificate present</i>	The device monitors the HTTPS server for self-created digital certificates.

### 14.3.2 Configuring the Security Status

Perform the following steps:

- Open the *Diagnostics > Status Configuration > Security Status* dialog, *Global* tab.
- For the parameters to be monitored, mark the checkbox in the *Monitor* column.
- To send an SNMP trap to the management station, activate the *Send trap* function in the *Traps* frame.
- Save the changes temporarily. To do this, click the  button.
- In the *Diagnostics > Status Configuration > Alarms (Traps)* dialog, create at least one trap destination that receives SNMP traps.

enable	Change to the Privileged EXEC mode.
configure	Change to the Configuration mode.
security-status monitor pwd-change	Monitors the password for the locally set up user accounts <i>user</i> and <i>admin</i> . When the password for the <i>user</i> or <i>admin</i> user accounts is the default setting, the value in the <i>Security status</i> frame changes to <i>error</i> .
security-status monitor pwd-min-length	Monitors the value specified in the <i>Min. password length</i> policy. When the value for the <i>Min. password length</i> policy is less than 8, the value in the <i>Security status</i> frame changes to <i>error</i> .
security-status monitor pwd-policy-config	Monitors the password policy settings. When the value for at least one of the following policies is specified as 0, the value in the <i>Security status</i> frame changes to <i>error</i> . <ul style="list-style-type: none"> <li>• <i>Upper-case characters (min.)</i></li> <li>• <i>Lower-case characters (min.)</i></li> <li>• <i>Digits (min.)</i></li> <li>• <i>Special characters (min.)</i></li> </ul>
security-status monitor pwd-policy-inactive	Monitors the password policy settings. When the value for at least one of the following policies is specified as 0, the value in the <i>Security status</i> frame changes to <i>error</i> .
security-status monitor telnet-enabled	Monitors the Telnet server. When you enable the Telnet server, the value in the <i>Security status</i> frame changes to <i>error</i> .



<code>security-status monitor http-enabled</code>	Monitors the HTTP server. When you enable the HTTP server, the value in the <i>Security status</i> frame changes to <i>error</i> .
<code>security-status monitor snmp-unsecure</code>	Monitors the SNMP server. When at least one of the following conditions applies, the value in the <i>Security status</i> frame changes to <i>error</i> : <ul style="list-style-type: none"><li>• The <i>SNMPv1</i> function is enabled.</li><li>• The <i>SNMPv2</i> function is enabled.</li><li>• The encryption for SNMPv3 is disabled. You enable the encryption in the <i>Device Security &gt; User Management</i> dialog, in the <i>SNMP encryption type</i> field.</li></ul>
<code>security-status monitor sysmon-enabled</code>	To monitor the activation of System Monitor 1 in the device.
<code>security-status monitor extnvm-upd-enabled</code>	To monitor the activation of the external non volatile memory update.
<code>security-status monitor iec61850-mms-enabled</code>	Monitors the <i>IEC61850-MMS</i> function. When you enable the <i>IEC61850-MMS</i> function, the value in the <i>Security status</i> frame changes to <i>error</i> .
<code>security-status trap</code>	When the device status changes, it sends an SNMP trap.

In order to enable the device to monitor an active link without a connection, first enable the global function, then enable the individual ports.

Perform the following steps:

- Open the *Diagnostics > Status Configuration > Security Status* dialog, *Global* tab.
- For the *Link interrupted on enabled device ports* parameter, mark the checkbox in the *Monitor* column.
- Save the changes temporarily. To do this, click the  button.
- Open the *Diagnostics > Status Configuration > Device Status* dialog, *Port* tab.
- For the *Link interrupted on enabled device ports* parameter, mark the checkbox in the column of the ports to be monitored.
- Save the changes temporarily. To do this, click the  button.

<code>enable</code>	Change to the Privileged EXEC mode.
<code>configure</code>	Change to the Configuration mode.
<code>security-status monitor no-link-enabled</code>	Monitors the link on active ports. When the link interrupts on an active port, the value in the <i>Security status</i> frame changes to <i>error</i> .
<code>interface 1/1</code>	Change to the interface configuration mode of interface <i>1/1</i> .
<code>security-status monitor no-link</code>	Monitors the link on interface/port <i>1</i> .

### 14.3.3 Displaying the Security Status

Perform the following steps:

-   Open the *Basic Settings > System* dialog.

 `show security-status all`

In the EXEC Privilege mode, display the security status and the setting for the security status determination.

## 14.4 Out-of-Band signaling

The device uses the signal contact to control external devices and monitor device functions. Function monitoring enables you to perform remote diagnostics.

The device reports the operating status using a break in the potential-free signal contact (relay contact, closed circuit) for the selected mode. The device monitors the following functions:

- ▶ Incorrect supply voltage
  - at least one of the 2 supply voltages is not operating
  - the internal supply voltage is not operating
- ▶ When the device is operating outside of the user-defined temperature threshold
- ▶ Events for ring redundancy
  - Loss of the redundancy (in ring manager mode)
  - In the default setting, ring redundancy monitoring is inactive. The device is a normal ring participant and detects an error in the local configuration.
- ▶ The interruption of link connection(s)
  - Configure at least one port for this feature. In the *Propagate connection error* frame, you specify which ports the device signals for a link interruption. In the default setting, link monitoring is inactive.
- ▶ The removal of the external memory.
- ▶ The configuration in the external memory does not match the configuration in the device.
- ▶ The removal of a module

Select the corresponding entries to decide which events the device status includes.

**Note:** With a non-redundant voltage supply, the device reports the absence of a supply voltage. To disable this message, feed the supply voltage over both inputs or ignore the monitoring.

### 14.4.1 Controlling the Signal contact

With the *Manual setting* mode you control this signal contact remotely.

Application options:

- ▶ Simulation of an error detected during SPS error monitoring
- ▶ Remote control of a device using SNMP, such as switching on a camera

Perform the following steps:

- Open the *Diagnostics > Status Configuration > Signal Contact* dialog, *Global* tab.
- To control the signal contact manually, in the *Configuration* frame, select the *Manual setting* item in the *Mode* drop-down list.
- To open the signal contact, you select the *open* radio button in the *Configuration* frame.
- To close the signal contact, you select the *close* radio button in the *Configuration* frame.
- Save the changes temporarily. To do this, click the  button.

enable

configure

Change to the Privileged EXEC mode.

Change to the Configuration mode.

signal-contact 1 mode manual	Select the manual setting mode for signal contact 1.
signal-contact 1 state open	Open signal contact 1.
signal-contact 1 state closed	Close signal contact 1.

## 14.4.2 Monitoring the Device and Security Statuses

In the *Configuration* field, you specify which events the signal contact indicates.

► *Device status*

Using this setting the signal contact indicates the status of the parameters monitored in the *Diagnostics > Status Configuration > Device Status* dialog.

► *Security status*

Using this setting the signal contact indicates the status of the parameters monitored in the *Diagnostics > Status Configuration > Security Status* dialog.

► *Device/Security status*

Using this setting the signal contact indicates the status of the parameters monitored in the *Diagnostics > Status Configuration > Device Status* and the *Diagnostics > Status Configuration > Security Status* dialog.

### Configuring the operation monitoring

Perform the following steps:

- Open the *Diagnostics > Status Configuration > Signal Contact* dialog, *Global* tab.
- To monitor the device functions using the signal contact, in the *Configuration* frame, specify the value *Monitoring correct operation* in the *Mode* field.
- For the parameters to be monitored, mark the checkbox in the *Monitor* column.
- To send an SNMP trap to the management station, activate the *Send trap* function in the *Traps* frame.
- Save the changes temporarily. To do this, click the  button.
- In the *Diagnostics > Status Configuration > Alarms (Traps)* dialog, create at least one trap destination that receives SNMP traps.
- Save the changes temporarily. To do this, click the  button.
- You specify the temperature thresholds for the temperature monitoring in the *Basic Settings > System* dialog.

enable	Change to the Privileged EXEC mode.
configure	Change to the Configuration mode.
signal-contact 1 monitor temperature	Monitors the temperature in the device. When the temperature exceeds / falls below the threshold values, the signal contact opens.

<pre>signal-contact 1 monitor ring- redundancy</pre>	<p>Monitors the ring redundancy. The signal contact opens in the following situations:</p> <ul style="list-style-type: none"><li>• The redundancy function becomes active (loss of redundancy reserve).</li><li>• The device is a normal ring participant and detects an error in its settings.</li></ul>
<pre>signal-contact 1 monitor link-failure</pre>	<p>Monitors the ports/interfaces link. When the link interrupts on a monitored port/interface, the signal contact opens.</p>
<pre>signal-contact 1 monitor envm-removal</pre>	<p>Monitors the active external memory. When you remove the active external memory from the device, the signal contact opens.</p>
<pre>signal-contact 1 monitor envm-not-in- sync</pre>	<p>Monitors the configuration profiles in the device and in the external memory. The signal contact opens in the following situations:</p> <ul style="list-style-type: none"><li>• The configuration profile only exists in the device.</li><li>• The configuration profile in the device differs from the configuration profile in the external memory.</li></ul>
<pre>signal-contact 1 monitor power-supply 1</pre>	<p>Monitors the power supply unit <b>1</b>. When the device has a detected power supply fault, the signal contact opens.</p>
<pre>signal-contact 1 monitor module-removal 1</pre>	<p>Monitors module <b>1</b>. When you remove module <b>1</b> from the device, the signal contact opens.</p>
<pre>signal-contact 1 trap</pre>	<p>Enables the device to send an SNMP trap when the status of the operation monitoring changes.</p>
<pre>no signal-contact 1 trap</pre>	<p>Disabling the SNMP trap</p>

In order to enable the device to monitor an active link without a connection, first enable the global function, then enable the individual ports.

Perform the following steps:

- In the *Monitor* column, activate the *Link interrupted on enabled device ports* function.
- Open the *Diagnostics > Status Configuration > Device Status* dialog, *Port* tab.

<pre>enable</pre>	<p>Change to the Privileged EXEC mode.</p>
<pre>configure</pre>	<p>Change to the Configuration mode.</p>
<pre>signal-contact 1 monitor link-failure</pre>	<p>Monitors the ports/interfaces link. When the link interrupts on a monitored port/interface, the signal contact opens.</p>
<pre>interface 1/1</pre>	<p>Change to the interface configuration mode of interface <b>1/1</b>.</p>
<pre>signal-contact 1 link-alarm</pre>	<p>Monitors the port/interface link. When the link interrupts on the port/interface, the signal contact opens.</p>

## Events which can be monitored

Table 34: *Device Status* events

Name	Meaning
<i>Temperature</i>	When the temperature exceeds or falls below the value specified.
<i>Ring redundancy</i>	When ring redundancy is present, enable this function to monitor.
<i>Connection errors</i>	Enable this function to monitor every port link event in which the <i>Propagate connection error</i> checkbox is active.
<i>Ethernet module removal</i>	Enable this global function to monitor the removal of a module. Also enable the individual module to monitor.
<i>External memory not in sync with NVM</i>	The device monitors synchronization between the device configuration and the configuration stored in the external memory ( <i>ENVM</i> ).
<i>External memory removed</i>	Enable this function to monitor the presence of an external storage device.
<i>Power supply</i>	Enable this function to monitor the power supply.

## Displaying the signal contact's status

The device gives you additional options for displaying the status of the signal contact:

- ▶ Display in the Graphical User Interface
- ▶ Query in the Command Line Interface

Perform the following steps:

- Open the *Basic Settings > System* dialog.  
The *Signal contact status* frame displays the signal contact status and informs you about alarms that have occurred. When an alarm currently exists, the frame is highlighted.

```
show signal-contact 1 all
```

Displays signal contact settings for the specified signal contact.

## 14.5 Port status indication









To view the status of the ports, perform the following steps:

-  □ Open the *Basic Settings > System* dialog.

The dialog displays the device with the current configuration. Furthermore, the dialog indicates the status of the individual ports with a symbol.

The following symbols represent the status of the individual ports. In some situations, these symbols interfere with one another. When you position the mouse pointer over the port icon, a bubble help displays a detailed description of the port state.

Table 35: Symbols identifying the status of the ports

Criterion	Symbol
Bandwidth of the port	 10 Mbit/s Port activated, connection okay, full-duplex mode
	 100 Mbit/s Port activated, connection okay, full-duplex mode
	 1000 Mbit/s Port activated, connection okay, full-duplex mode
	 1000 Mbit/s Port activated, connection okay, full-duplex mode
Operating state	 Half-duplex mode enabled See the <i>Basic Settings &gt; Port</i> dialog, <i>Configuration</i> tab, <i>Automatic configuration</i> checkbox, <i>Manual configuration</i> field and <i>Manual cable crossing (Auto. conf. off)</i> field.
	 Autonegotiation enabled See the <i>Basic Settings &gt; Port</i> dialog, <i>Configuration</i> tab, <i>Automatic configuration</i> checkbox.
	 The port is blocked by a redundancy function.
AdminLink	 The port is deactivated, connection okay
	 The port is deactivated, no connection set up See the <i>Basic Settings &gt; Port</i> dialog, <i>Configuration</i> tab, <i>Port on</i> checkbox and <i>Link/Current settings</i> field.

## 14.6 Port event counter

The port statistics table lets experienced network administrators identify possible detected problems in the network.

This table displays the contents of various event counters. The packet counters add up the events sent and the events received. In the [Basic Settings > Restart](#) dialog, you can reset the event counters.

Table 36: Examples indicating known weaknesses

Counter	Indication of known possible weakness
Received fragments	<ul style="list-style-type: none"> <li>• Non-functioning controller of the connected device</li> <li>• Electromagnetic interference in the transmission medium</li> </ul>
CRC Error	<ul style="list-style-type: none"> <li>• Non-functioning controller of the connected device</li> <li>• Electromagnetic interference in the transmission medium</li> <li>• Inoperable component in the network</li> </ul>
Collisions	<ul style="list-style-type: none"> <li>• Non-functioning controller of the connected device</li> <li>• Network over extended/lines too long</li> <li>• Collision or a detected fault with a data packet</li> </ul>

Perform the following steps:

- To display the event counter, open the [Basic Settings > Port](#) dialog, [Statistics](#) tab.
- To reset the counters, in the [Basic Settings > Restart](#) dialog, click the [Clear port statistics](#) button.

### 14.6.1 Detecting non-matching duplex modes

Problems occur when 2 ports directly connected to each other have mismatching duplex modes. These problems are difficult to track down. The automatic detection and reporting of this situation has the benefit of recognizing mismatching duplex modes before problems occur.

This situation arises from an incorrect configuration, for example, deactivation of the automatic configuration on the remote port.

A typical effect of this non-matching is that at a low data rate, the connection seems to be functioning, but at a higher bi-directional traffic level the local device records a lot of CRC errors, and the connection falls significantly below its nominal capacity.

The device lets you detect this situation and report it to the network management station. In the process, the device evaluates the error counters of the port in the context of the port settings.

#### Possible causes of port error events

The following table lists the duplex operating modes for TX ports, with the possible fault events. The meanings of terms used in the table are as follows:

- ▶ Collisions  
In half-duplex mode, collisions mean normal operation.
- ▶ Duplex problem  
Mismatching duplex modes.



- ▶ EMI  
Electromagnetic interference.
- ▶ Network extension  
The network extension is too great, or too many cascading hubs.
- ▶ Collisions, Late Collisions  
In full-duplex mode, no incrementation of the port counters for collisions or Late Collisions.
- ▶ CRC Error  
The device evaluates these errors as non-matching duplex modes in the manual full duplex mode.

Table 37: Evaluation of non-matching of the duplex mode

No.	Automatic configuration	Current duplex mode	Detected error events (≥ 10 after link up)	Duplex modes	Possible causes
1	marked	Half duplex	None	OK	
2	marked	Half duplex	Collisions	OK	
3	marked	Half duplex	Late Collisions	Duplex problem detected	Duplex problem, EMI, network extension
4	marked	Half duplex	CRC Error	OK	EMI
5	marked	Full duplex	None	OK	
6	marked	Full duplex	Collisions	OK	EMI
7	marked	Full duplex	Late Collisions	OK	EMI
8	marked	Full duplex	CRC Error	OK	EMI
9	unmarked	Half duplex	None	OK	
10	unmarked	Half duplex	Collisions	OK	
11	unmarked	Half duplex	Late Collisions	Duplex problem detected	Duplex problem, EMI, network extension
12	unmarked	Half duplex	CRC Error	OK	EMI
13	unmarked	Full duplex	None	OK	
14	unmarked	Full duplex	Collisions	OK	EMI
15	unmarked	Full duplex	Late Collisions	OK	EMI
16	unmarked	Full duplex	CRC Error	Duplex problem detected	Duplex problem, EMI

## 14.7 Auto-Disable

The device can disable a port due to several configurable reasons. Each reason causes the port to “shut down”. In order to recover the port from the shut down state, you can manually clear the condition which caused the port to shut down or specify a timer to automatically re-enable the port.

If the configuration displays a port as enabled, but the device detects an error or change in the condition, then the software shuts down that port. In other words, the device software disables the port because of a detected error or change in the condition.

If a port is auto-disabled, then the device effectively shuts down the port and the port blocks traffic. The port LED blinks green 3 times per period and identifies the reason for the shutdown. In addition, the device creates a log file entry which lists the causes of the deactivation. When you re-enable the port after a timeout using the *Auto-Disable* function, the device generates a log entry.

The *Auto-Disable* function provides a recovery function which automatically enables an auto-disabled port after a user-defined time. When this function enables a port, the device sends an SNMP trap with the port number, but without a value for the *Reason* parameter.

The *Auto-Disable* function serves the following purposes:

- ▶ It assists the network administrator in port analysis.
- ▶ It reduces the possibility that this port causes the network to be instable.

The *Auto-Disable* function is available for the following functions:

- ▶ *Link flap* (*Port Monitor* function)
- ▶ *CRC/Fragments* (*Port Monitor* function)
- ▶ Duplex Mismatch detection (*Port Monitor* function)
- ▶ *Spanning Tree*
- ▶ *Port Security*
- ▶ *Overload detection* (*Port Monitor* function)
- ▶ *Link speed/Duplex mode detection* (*Port Monitor* function)

In the following example, you configure the device to disable a port due to detected violations to the thresholds specified the *Diagnostics > Ports > Port Monitor* dialog, *CRC/Fragments* tab, and then automatically re-enable the disabled port.

Perform the following steps:

- Open the *Diagnostics > Ports > Port Monitor* dialog, *CRC/Fragments* tab.
- Verify that the thresholds specified in the table concur to your preferences for port 1/1.
- Open the *Diagnostics > Ports > Port Monitor* dialog, *Global* tab.
- To enable the function, select the *On* radio button in the *Operation* frame.
- To allow the device to disable the port due to detected errors, mark the checkbox in the *CRC/Fragments on* column for port 1/1.

- In the *Action* column you can choose how the device reacts to detected errors. In this example, the device disables port 1/1 for threshold violations and then automatically re-enables the port.
  - ▶ To allow the device to disable and automatically re-enable the port, select the value *auto-disable* and configure the *Auto-Disable* function. The value *auto-disable* only works in conjunction with the *Auto-Disable* function.The device can also disable a port without auto re-enabling.
  - ▶ To allow the device to disable the port only, select the value *disable port*. To manually re-enable a disabled port, highlight the port.  
Click the  button and then the *Reset* item.
  - ▶ When you configure the *Auto-Disable* function, the value *disable port* also automatically re-enables the port.
- Open the *Diagnostics > Ports > Port Monitor* dialog, *Auto-disable* tab.
- To allow the device to auto re-enable the port after it was disabled due to detected threshold violations, mark the checkbox in the *CRC error* column.
- Open the *Diagnostics > Ports > Port Monitor* dialog, *Port* tab.
- Specify the delay time as 120 s in the *Reset timer [s]* column for the ports you want to enable.

**Note:** The *Reset* item lets you enable the port before the time specified in the *Reset timer [s]* column counts down.

<code>enable</code>	Change to the Privileged EXEC mode.
<code>configure</code>	Change to the Configuration mode.
<code>interface 1/1</code>	Change to the interface configuration mode of interface 1/1.
<code>port-monitor condition crc-fragments count 2000</code>	Specifying the CRC-Fragment counter to 2000 parts per million.
<code>port-monitor condition crc-fragments interval 15</code>	Sets the measure interval to 15 seconds for CRC-Fragment detection.
<code>auto-disable timer 120</code>	Specifies the waiting period of 120 seconds, after which the <i>Auto-disable</i> function re-enables the port.
<code>exit</code>	Change to the Configuration mode.
<code>auto-disable reason crc-error</code>	Activate the auto-disable CRC function.
<code>port-monitor condition crc-fragments mode</code>	Activate the CRC-Fragments condition to trigger an action.
<code>port-monitor operation</code>	Activate the <i>Port Monitor</i> function.

When the device disables a port due to threshold violations, the device lets you use the following commands to manually reset the disabled port.

Perform the following steps:

<code>enable</code>	Change to the Privileged EXEC mode.
<code>configure</code>	Change to the Configuration mode.
<code>interface 1/1</code>	Change to the interface configuration mode of interface 1/1.
<code>auto-disable reset</code>	Lets you enable the port before the Timer counts down.

## 14.8 Displaying the SFP status

The SFP status display lets you look at the current SFP module connections and their properties. The properties include:

- ▶ module type
- ▶ serial number of media module
- ▶ temperature in ° C
- ▶ transmission power in mW
- ▶ receive power in mW

Perform the following step:

-   Open the *Diagnostics > Ports > SFP* dialog.

## 14.9 Topology discovery

IEEE 802.1AB defines the Link Layer Discovery Protocol (LLDP). LLDP lets you automatically detect the LAN network topology.

Devices with LLDP active:

- ▶ broadcast their connection and management information to neighboring devices on the shared LAN. When the receiving device has its *LLDP* function active, evaluation of the devices occur.
- ▶ receive connection and management information from neighbor devices on the shared LAN, provided these adjacent devices also have LLDP active.
- ▶ build a management information database and object definitions for storing information about adjacent devices with LLDP active.

As the main element, the connection information contains an exact, unique identifier for the connection end point: MAC (Service Access Point). This is made up of a device identifier which is unique on the entire network and a unique port identifier for this device.

- ▶ Chassis identifier (its MAC address)
- ▶ Port identifier (its port-MAC address)
- ▶ Description of port
- ▶ System name
- ▶ System description
- ▶ Supported system capabilities
- ▶ System capabilities currently active
- ▶ Interface ID of the management address
- ▶ VLAN-ID of the port
- ▶ Auto-negotiation status on the port
- ▶ Medium, half/full duplex setting and port speed setting
- ▶ Information about the VLANs installed in the device (VLAN-ID and VLAN name, irrespective of whether the port is a VLAN participant).

A network management station can call up this information from devices with activated LLDP. This information enables the network management station to map the topology of the network.

Non-LLDP devices normally block the special Multicast LLDP IEEE MAC address used for information exchange. Non-LLDP devices therefore discard LLDP packets. If you position a non-LLDP capable device between 2 LLDP capable devices, then the non-LLDP capable device prohibits information exchanges between the 2 LLDP capable devices.

The Management Information Base (MIB) for a device with LLDP capability holds the LLDP information in the `lldp` MIB and in the private `HM2-LLDP-EXT-HM-MIB` and `HM2-LLDP-MIB`.

### 14.9.1 Displaying the Topology discovery results

Display the topology of the network. To do this, perform the following step:

-   Open the *Diagnostics > LLDP > Topology Discovery* dialog, *LLDP* tab.

When you use a port to connect several devices, for example via a hub, the table contains a line for each connected device.

Activating Display FDB Entries at the bottom of the table lets you display devices without active LLDP support in the table. In this case, the device also includes information from its FDB (forwarding database).

If you connect the port to devices with the topology discovery function active, then the devices exchange LLDP Data Units (LLDPDU) and the topology table displays these neighboring devices.

When a port connects only devices without an active topology discovery, the table contains a line for this port to represent the connected devices. This line contains the number of connected devices.

The FDB address table contains MAC addresses of devices that the topology table hides for the sake of clarity.

## 14.9.2 LLDP-Med

LLDP for Media Endpoint Devices (LLDP-MED) is an extension to LLDP that operates between endpoint devices. Endpoints include devices such as IP phones, or other Voice over IP (VoIP) devices or servers and network devices such as switches. It specifically provides support for VoIP applications. LLDP-MED provides this support using an additional set of common type-length-value (TLV) advertisement messages, for capabilities discovery, network policy, Power over Ethernet, inventory management and location information.

The device supports the following TLV messages:

- ▶ capabilities TLV  
Lets the LLDP-MED endpoints determine the capabilities that the connected device supports and what capabilities the device has enabled.
- ▶ Network policy TLV  
Lets both network connectivity devices and endpoints advertise VLAN configurations and associated attributes for the specific application on that port. For example, the device notifies a phone of the VLAN number. The phone connects to a switch, obtain its VLAN number, and then starts communicating with the call control.

LLDP-MED provides the following functions:

- ▶ Network policy discovery, including VLAN ID, 802.1p priority and Diffserv code point (DSCP)
- ▶ Device location and topology discovery based on LAN-level MAC/port information
- ▶ Endpoint move detection notification, from network connectivity device to the associated VoIP management application
- ▶ Extended device identification for inventory management
- ▶ Identification of endpoint network connectivity capabilities, for example, multi-port IP Phone with embedded switch or bridge capability
- ▶ Application level interactions with the LLDP protocol elements to provide timely startup of LLDP to support rapid availability of an Emergency Call Service
- ▶ Applicability of LLDP-MED to Wireless LAN environments, support for Voice over Wireless LAN

## 14.10 Detecting loops

Loops in the network cause connection interruptions or data loss. This also applies to temporary loops. The automatic detection and reporting of this situation lets you detect it faster and diagnose it more easily.

An incorrect configuration causes loops, for example, deactivating Spanning Tree.

The device lets you detect the effects typically caused by loops and report this situation automatically to the network management station. You have the option here to specify the magnitude of the loop effects that trigger the device to send a report.

BPDU frames sent from the designated port and received on either a different port of the same device or the same port within a short time, is a typical effect of a loop.

To check if the device has detected a loop, perform the following steps:

- Open the *Switching > L2-Redundancy > Spanning Tree > Port* dialog, *CIST* tab.
- Check the value in the *Port state* and *Port role* fields. If the *Port state* field displays the value *discarding* and the *Port role* field displays the value *backup*, then the port is in a loop status.  
or
- Open the *Switching > L2-Redundancy > Spanning Tree > Port* dialog, *Guards* tab.
- Check the value in the *Loop state* column. If the field displays the value *true*, then the port is in a loop status.

## 14.11 Reports

The following lists reports and buttons available for diagnostics:

- ▶ System Log file  
The log file is an HTML file in which the device writes device-internal events.
- ▶ Audit Trail  
Logs successful commands and user comments. The file also includes SNMP logging.
- ▶ Persistent Logging  
When the external memory is present, the device saves log entries in a file in the external memory. These files are available after power down. The maximum size, maximum number of retainable files and the severity of logged events are configurable. After obtaining the user-defined maximum size or maximum number of retainable files, the device archives the entries and starts a new file. The device deletes the oldest file and renames the other files to maintain the configured number of files. To review these files use the Command Line Interface or copy them to an external server for future reference.
- ▶ [Download support information](#)  
This button lets you download system information as a ZIP archive.

In service situations, these reports provide the technician with the necessary information.

### 14.11.1 Global settings

Using this dialog you enable or disable where the device sends reports, for example, to a Console, a Syslog Server, or a connection to the Command Line Interface. You also set at which severity level the device writes events into the reports.

Perform the following steps:

- Open the [Diagnostics > Report > Global](#) dialog.
- To send a report to the console, specify the desired level in the [Console logging](#) frame, [Severity](#) field.
- To enable the function, select the *On* radio button in the [Console logging](#) frame.
- Save the changes temporarily. To do this, click the  button.

The device buffers logged events in 2 separate storage areas so that the device keeps log entries for urgent events. Specify the minimum severity for events that the device logs to the buffered storage area with a higher priority.

Perform the following steps:

- To send events to the buffer, specify the desired level in the [Buffered logging](#) frame, [Severity](#) field.
- Save the changes temporarily. To do this, click the  button.

When you activate the logging of SNMP requests, the device logs the requests as events in the Syslog. The [Log SNMP get request](#) function logs user requests for device configuration information. The [Log SNMP set request](#) function logs device configuration events. Specify the minimum level for events that the device logs in the Syslog.



Perform the following steps:

- Enable the *Log SNMP get request* function for the device in order to send SNMP Read requests as events to the Syslog server.  
To enable the function, select the *On* radio button in the *SNMP logging* frame.
- Enable the *Log SNMP set request* function for the device in order to send SNMP Write requests as events to the Syslog server.  
To enable the function, select the *On* radio button in the *SNMP logging* frame.
- Choose the desired severity level for the get and set requests.
- Save the changes temporarily. To do this, click the  button.

When active, the device logs configuration changes made using the Command Line Interface, to the audit trail. This feature is based on the IEEE 1686 standard for Substation Intelligent Electronic Devices.

Perform the following steps:

- Open the *Diagnostics > Report > Global* dialog.
- To enable the function, select the *On* radio button in the *CLI logging* frame.
- Save the changes temporarily. To do this, click the  button.

The device lets you save the following system information data in one ZIP file on your PC:

- ▶ audittrail.html
- ▶ CLICommands.txt
- ▶ defaultconfig.xml
- ▶ script
- ▶ runningconfig.xml
- ▶ supportinfo.html
- ▶ systeminfo.html
- ▶ systemlog.html

The device creates the file name of the ZIP archive automatically in the format `<IP_address>_<system_name>.zip`.

Perform the following steps:



- Click the  button and then the *Download support information* item.
- Select the directory in which you want to save the support information.
- Save the changes temporarily. To do this, click the  button.

## 14.11.2 Syslog

The device enables you to send messages about device internal events to one or more Syslog servers (up to 8). Additionally, you also include SNMP requests to the device as events in the Syslog.

**Note:** To display the logged events, open the *Diagnostics > Report > Audit Trail* dialog or the *Diagnostics > Report > System Log* dialog.

Perform the following steps:

- Open the *Diagnostics > Syslog* dialog.
- To add a table entry, click the  button.
- In the *IP address* column, enter the IP address of the Syslog server.
- In the *Destination UDP port* column, specify the UDP port on which the Syslog server expects the log entries.
- In the *Min. severity* column, specify the minimum severity level that an event requires for the device to send a log entry to this Syslog server.
- Mark the checkbox in the *Active* column.
- To enable the function, select the *On* radio button in the *Operation* frame.
- Save the changes temporarily. To do this, click the  button.

In the *SNMP logging* frame, configure the following settings for read and write SNMP requests:

Perform the following steps:

- Open the *Diagnostics > Report > Global* dialog.
- Enable the *Log SNMP get request* function for the device in order to send SNMP Read requests as events to the Syslog server.  
To enable the function, select the *On* radio button in the *SNMP logging* frame.
- Enable the *Log SNMP set request* function for the device in order to send SNMP Write requests as events to the Syslog server.  
To enable the function, select the *On* radio button in the *SNMP logging* frame.
- Choose the desired severity level for the get and set requests.
- Save the changes temporarily. To do this, click the  button.

```
enable
configure
logging host add 1 addr 10.0.1.159
severity 3

logging syslog operation
exit
show logging host
No.      Server IP      Port  Max. Severity  Type        Status
-----
1        10.0.1.159    514   error          systemlog   active
configure
```

Change to the Privileged EXEC mode.

Change to the Configuration mode.

Adds a new recipient in the Syslog servers list. The value 3 specifies the severity level of the event that the device logs. The value 3 means *error*.

Enable the *Syslog* function.

Change to the Privileged EXEC mode.

Display the Syslog host settings.

Change to the Configuration mode.

```
logging snmp-requests get operation
logging snmp-requests get severity 5

logging snmp-requests set operation
logging snmp-requests set severity 5

exit

show logging snmp

Log SNMP GET requests      : enabled
Log SNMP GET severity      : notice
Log SNMP SET requests      : enabled
Log SNMP SET severity      : notice
```

Logs SNMP GET requests.

The value `5` specifies the severity level of the event that the device logs in case of SNMP GET requests. The value `5` means *notice*.

Logs SNMP SET requests.

The value `5` specifies the severity level of the event that the device logs in case of SNMP SET requests. The value `5` means *notice*.



Change to the Privileged EXEC mode.

Display the SNMP logging settings.

### 14.11.3 System Log

The device lets you call up a log file of the system events. The table in the [Diagnostics > Report > System Log](#) dialog lists the logged events.

Perform the following steps:

- To update the content of the log, click the  button.
- To save the content of the log as an html file, click the  button and then the *Reset* item.
- To delete the content of the log, click the  button and then the *Reset* item.
- To search the content of the log for a key word, use the search function of your web browser.

**Note:** You have the option to also send the logged events to one or more Syslog servers.

### 14.11.4 Audit Trail

The [Diagnostics > Report > Audit Trail](#) dialog contains system information and changes to the device configuration performed through the Command Line Interface and SNMP. In the case of device configuration changes, the dialog displays Who changed What and When.

The [Diagnostics > Syslog](#) dialog lets you specify up to 8 Syslog servers to which the device sends Audit Trails.

The following list contains log events:

- ▶ changes to configuration parameters
- ▶ Commands (except `show` commands) using the Command Line Interface
- ▶ Command `logging audit-trail <string>` using the Command Line Interface which logs the comment
- ▶ Automatic changes to the System Time
- ▶ watchdog events
- ▶ locking a user after several unsuccessful login attempts
- ▶ User login, either locally or remote, using the Command Line Interface

- ▶ Manual, user-initiated, logout
- ▶ Timed logout after a user-defined period of inactivity in the Command Line Interface
- ▶ file transfer operation including a Firmware Update
- ▶ Configuration changes using HiDiscovery
- ▶ Automatic configuration or firmware updates using the external memory
- ▶ Blocked access to the device management due to invalid login
- ▶ rebooting
- ▶ opening and closing SNMP over HTTPS tunnels
- ▶ Detected power failures

## 14.12 Network analysis with TCPdump

Tcpdump is a packet-sniffing UNIX utility used by network administrators to sniff and analyze traffic on a network. A couple of reasons for sniffing traffic on a network is to verify connectivity between hosts, or to analyze the traffic traversing the network.

TCPDump in the device provides the possibility to decode or capture packets received and transmitted by the Management CPU. This function is available using the `debug` command. Refer to the “Command Line Interface” reference manual for further information about the TCPDump function.

## 14.13 Monitoring the data traffic

The device lets you forward data packets that pass through the device to a destination port. There you can monitor and evaluate the data packets.

The device provides you with the following options:

- ▶ [Port Mirroring](#)

### 14.13.1 Port Mirroring

The [Port Mirroring](#) function lets you copy data packets from physical source ports to a physical destination port.

You monitor the data traffic on the source ports in the sending and receiving directions with a management tool connected on the destination port, for example an RMON probe. The function has no affect on the data traffic running on the source ports.

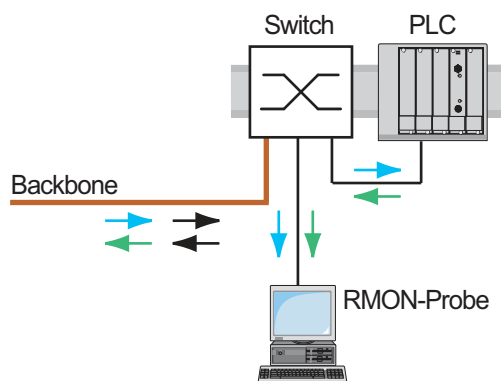

Figure 55: Example

On the destination port, the device only forwards the data packets copied from the source ports.

Before you switch on the [Port Mirroring](#) function, mark the checkbox [Allow management](#) to access the device management via the destination port. The device lets users access the device management via the destination port without interrupting the active [Port Mirroring](#) session.

**Note:** The device duplicates multicasts, broadcasts and unknown unicasts on the destination port.

The VLAN settings on the destination port remain unchanged. Prerequisite for access to the device management on the destination port is that the destination port is a member of the device management VLAN.

Restrictions apply to ports on which the following redundancy protocols are active:

- ▶ **Fast MRP** (depends on hardware)  
No port mirroring of sent MRP test packets.
- ▶ **HSR, PRP** (depends on hardware)  
To monitor the data stream on HSR/PRP ports, specify the source port 1/1. On the source port 1/1, the [Port Mirroring](#) function records:
  - Data packets coming into the HSR/PRP network from the outside through the device
  - Data packets after duplicate recognition that leave the HSR/PRP network through the device
  - No Link Local packets that protocols like LLDP work with

### Enabling the Port Mirroring function

Perform the following steps:

- Open the *Diagnostics > Ports > Port Mirroring* dialog.
- Specify the source ports.  
Mark the checkbox in the *Enabled* column for the relevant ports.
- Specify the destination port.  
In the *Destination port* frame, select the desired port in the *Primary port* drop-down list.  
The drop-down list only displays available ports. Ports that are already specified as source ports are unavailable.
- In order to access the device management via the destination port:  
In the *Destination port* frame, mark the *Allow management* checkbox.
- Save the changes temporarily. To do this, click the  button.

To deactivate the *Port Mirroring* function and restore the default settings, click the  button and then the *Reset config* item.

## 14.14 Self-test

The device checks its assets during the boot process and occasionally thereafter. The device checks system task availability or termination and the available amount of memory. Furthermore, the device checks for application functionality and any hardware degradation in the chip set.

If the device detects a loss in integrity, then the device responds to the degradation with a user-defined action. The following categories are available for configuration.

- ▶ `task`  
Action to be taken in case a task is unsuccessful.
- ▶ `resource`  
Action to be taken due to the lack of resources.
- ▶ `software`  
Action taken for loss of software integrity; for example, code segment checksum or access violations.
- ▶ `hardware`  
Action taken due to hardware degradation

Configure each category to produce an action in case the device detects a loss in integrity. The following actions are available for configuration.

- ▶ `log only`  
This action writes a message to the logging file.
- ▶ `send trap`  
Sends an SNMP trap to the trap destination.
- ▶ `reboot`  
If activated, then an error in the category will cause the device to reboot

Perform the following steps:

- Open the [Diagnostics > System > Selftest](#) dialog.
- In the [Action](#) column, specify the action to perform for a cause.
- Save the changes temporarily. To do this, click the  button.

<code>enable</code>	Change to the Privileged EXEC mode.
<code>configure</code>	Change to the Configuration mode.
<code>selftest action task log-only</code>	To send a message to the event log when a task is unsuccessful.
<code>selftest action resource send-trap</code>	When there are insufficient resources, send an SNMP trap.
<code>selftest action software send-trap</code>	When the software integrity has been lost, send an SNMP trap.
<code>selftest action hardware reboot</code>	To reboot the device when hardware degradation occurs.

Disabling these functions lets you decrease the time required to restart the device after a cold start. You find these options in the [Diagnostics > System > Selftest](#) dialog, [Configuration](#) frame.

- ▶ [RAM test](#)  
Activates/deactivates the [RAM test](#) function during a cold start.



- ▶ *SysMon1 is available*  
Activates/deactivates the System Monitor function during a cold start.
- ▶ *Load default config on error*  
Activates/deactivates the loading of the default device configuration in case no readable configuration is available during a restart.

The following settings block your access to the device permanently in case the device does not detect any readable configuration profile at restart.

- ▶ The *SysMon1 is available* checkbox is unmarked.
- ▶ The *Load default config on error* checkbox is unmarked.

This is the case, for example, when the password of the configuration profile that you are loading differs from the password set in the device. To have the device unlocked again, contact your sales partner.

Perform the following steps:

```
selftest ramtest
```

Enable RAM selftest on cold start.

```
no selftest ramtest
```

Disable the "ramtest" function.

```
selftest system-monitor
```

Enable the "SysMon1" function.

```
no selftest system-monitor
```

Disable the "SysMon1" function.

```
show selftest action
```

Show status of the actions to be taken in the event of device degradation.

```
show selftest settings
```

Display the settings for "ramtest" and "SysMon" settings in event of a cold start.

## 14.15 Copper cable test

Use this feature to test copper cables attached to an interface for a short or open circuit. The test interrupts traffic flow, when in progress, on this port.

The table displays the state and lengths of each individual pair. The device returns a result with the following meaning:

- ▶ normal - indicates that the cable is operating properly
- ▶ open - indicates an interruption in the cable
- ▶ short circuit - indicates a short circuit in the cable
- ▶ untested - indicates an untested cable
- ▶ Unknown - cable unplugged



## 15 Advanced functions of the device

### 15.1 Using the device as a DHCP server

A DHCP server ("Dynamic Host Configuration Protocol") assigns IP addresses, Gateways, and other networking definitions such as DNS and NTP parameters to clients.

The DHCP operations fall into 4 basic phases: IP discovery, IP lease offer, IP request, and IP lease acknowledgment. Use the acronym DORA which stands for Discovery, Offer, Request, and Acknowledgement to help remember the phases. The server receives client data on UDP port 67 and forwards data to the client on UDP port 68.

The DHCP server provides an IP address pool or "pool", from which it allocates IP addresses to clients. The pool consists of a list of entries. An entry defines either a specific IP address or an IP address range.

The device lets you activate the DHCP server globally and per interface.

#### 15.1.1 IP Addresses assigned per port or per VLAN



The DHCP server assigns a static IP address or dynamic range of IP addresses to a client connected to a port or a VLAN. The device lets you create entries for either a port or a VLAN. When creating an entry to assign an IP address to a VLAN, the port entry grays out. When creating an entry to assign an IP address to a port, the VLAN entry grays out.

Static allocation means that the DHCP server assigns the same IP address to a specific client. The DHCP server identifies the client using a unique hardware ID. A static address entry contains one IP address, and applies it to a port or VLAN on which the server receives a request from a specific client. For static allocation, create a pool entry for the ports or one specific port, enter the IP address, and leave the *Last IP address* column empty. Specify a hardware ID with which the DHCP server uniquely identifies the client. This ID is either a MAC address, a client ID, a remote ID, or a circuit ID. When a client contacts the server with the configured hardware ID, the DHCP server allocates the static IP address.

The device also lets you assign a dynamic IP address range to ports or VLANs from which the DHCP server allocates a free IP address from a pool. To add a dynamic pool entry for the ports or VLANs, specify the first and last IP addresses for the IP address range, leaving the *MAC address*, *Client ID*, *Remote ID*, and *Circuit ID* columns empty. Creating multiple pool entries lets you have IP address ranges that contain gaps.

### 15.1.2 DHCP server static IP address example

In this example, configure the device to allocate a static IP address to a port. The device recognizes clients with unique hardware identification. The Hardware ID in this case is the client MAC address `00:24:E8:D6:50:51`. To do this, perform the following steps:

- Open the *Advanced > DHCP Server > Pool* dialog.
- To add a table entry, click the  button.
- In the *IP address* column, specify the value `192.168.23.42`.
- In the *Port* column, specify the value `1/1`.
- In the *MAC address* column, specify the value `00:24:E8:D6:50:51`.
- To assign the IP address to the client infinitely, in the *Lease time [s]* column, specify the value `4294967295`.
- Mark the checkbox in the *Active* column.
- Open the *Advanced > DHCP Server > Global* dialog.
- For port `1/1`, mark the checkbox in the *DHCP server active* column.
- To enable the function, select the *On* radio button in the *Operation* frame.
- Save the changes temporarily. To do this, click the  button.

```
enable
configure
dhcp-server pool add 1 static
192.168.23.42

dhcp-server pool modify 1 mode
interface 1/1

dhcp-server pool modify 1 mode mac
00:24:E8:D6:50:51

dhcp-server pool mode 1

dhcp-server pool modify 1 leasetime
infinite

dhcp-server operation

interface 1/1

dhcp-server operation
```

Change to the Privileged EXEC mode.

Change to the Configuration mode.

Creating an entry with index `1` and adding the IP address `192.168.23.42` to the static pool.

Assign the static address in index `1` to interface `1/1`.

Assign the IP address in index `1` to the device with the MAC address `00:24:E8:D6:50:51`.

Enable the index `1` pool entry.

To allocate the IP address to the client infinitely, modify the entry with index `1`.



Enable the DHCP server globally.

Change to the interface configuration mode of interface `1/1`.

Activate the *DHCP Server* server function on this port.

### 15.1.3 DHCP server dynamic IP address range example

The device lets you create dynamic IP address ranges. Leave the *MAC address*, *Client ID*, *Remote ID* and *Circuit ID* fields empty. To create dynamic IP address ranges with gaps between the ranges add several entries to the table. To do this, perform the following steps:

- Open the *Advanced > DHCP Server > Pool* dialog.
  - To add a table entry, click the  button.
  - In the *IP address* column, specify the value `192.168.23.92`. This is the first IP address of the range.
  - In the *Last IP address* column, specify the value `192.168.23.142`. This is the last IP address of the range.
- In the *Lease time [s]* column, the default setting is 60 days.
- In the *Port* column, specify the value `1/2`.
  - Mark the checkbox in the *Active* column.
  - Open the *Advanced > DHCP Server > Global* dialog.
  - For port `1/2`, mark the checkbox in the *DHCP server active* column.
  - To enable the function, select the *On* radio button in the *Operation* frame.
  - Save the changes temporarily. To do this, click the  button.

```
enable
configure
dhcp-server pool add 2 dynamic
192.198.23.92 192.168.23.142

dhcp-server pool modify 2 leasetime
(seconds | infinite)

dhcp-server pool add 3 dynamic
192.198.23.172 192.168.23.180

dhcp-server pool modify 3 leasetime
(seconds | infinite)

dhcp-server pool mode 2

dhcp-server pool mode 3

dhcp-server operation

interface 2/1

dhcp-server operation
```

Change to the Privileged EXEC mode.

Change to the Configuration mode.

Add a dynamic pool with an IP range from `192.168.23.92` to `192.168.23.142`.

Entering the Lease Time in seconds or infinite.

Add a dynamic pool with an IP range from `192.168.23.172` to `192.168.23.180`.

Entering the Lease Time in seconds or infinite.

Enable the index `2` pool entry.

Enable the index `3` pool entry.

Enable the DHCP server globally.

Change to the interface configuration mode of interface `2/1`.

Activate the *DHCP Server* server function on this port.

## 15.2 DHCP L2 Relay

A network administrator uses the DHCP Layer 2 *Relay Agent* to add DHCP client information. This information is required by Layer 3 *Relay Agents* and DHCP servers to assign an address and configuration to a client.

When a DHCP client and server are in the same IP subnet, they exchange IP address requests and replies directly. However, having a DHCP server on each subnet is expensive and often impractical. An alternative to having a DHCP server in every subnet is to use the network devices to relay packets between a DHCP client and a DHCP server located in a different subnet.

A Layer 3 *Relay Agent* is generally a router that has IP interfaces in both the client and server subnets and routes traffic between them. However, in Layer 2 switched networks, there are one or more network devices, switches for example, between the client and the Layer 3 *Relay Agent* or DHCP server. In this case, this device provides a Layer 2 *Relay Agent* to add the information that the Layer 3 *Relay Agent* and DHCP server require to perform their roles in address and configuration assignment.

The following list contains the default settings for this function:

- ▶ Global setting:
  - Active setting: disable
- ▶ Interface settings:
  - Active setting: disable
  - Trusted Port: disable
- ▶ VLAN settings:
  - Active setting: disable
  - *Circuit ID*: enable
  - *Remote ID* Type: mac
  - *Remote ID*: blank

### 15.2.1 Circuit and Remote IDs

In an IPv4 environment, before forwarding the request of a client to the DHCP server, the device adds the *Circuit ID* and the *Remote ID* to the *Option 82* field of the DHCP request packet.

- ▶ The *Circuit ID* stores on which port the device received the request of the client.
- ▶ The *Remote ID* contains the MAC address, the IP address, the system name, or a user-defined character string. Using it, the participating devices identify the *Relay Agent* that received the request of the client.

The device and other *Relay Agents* use this information to re-direct the answer from the DHCP *Relay Agent* to the original client. The DHCP server is able to analyze this data for example to assign the client an IP address from a specific address pool.

Also, the replay packet of the DHCP server contains the *Circuit ID* and the *Remote ID*. Before forwarding the answer to the client, the device removes the information from the *Option 82* field.

## 15.2.2 DHCP L2 Relay configuration

The *Advanced > DHCP L2 Relay > Configuration* dialog lets you activate the function on the active ports and on the VLANs. In the *Operation* frame, select the *On* radio button. Then click the  button.

The device forwards DHCPv4 packets with *Option 82* information on those ports for which the checkbox in the *DHCP L2 Relay* column and in the *Trusted port* column is marked. Typically, these are ports in the network of the DHCP server.

The ports to which the DHCP clients are connected, you activate the *DHCP L2 Relay* function, but leave the *Trusted port* checkbox unmarked. On these ports, the device discards DHCPv4 packets with *Option 82* information.

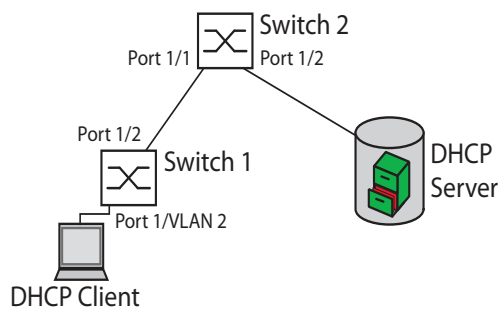

Figure 56: DHCP Layer 2 Example Network

Perform the following steps on Switch 1:

- Open the *Advanced > DHCP L2 Relay > Configuration* dialog, *Interface* tab.
- For port *1/1*, specify the settings as follows:
  - Mark the checkbox in the *Active* column.
- For port *1/2*, specify the settings as follows:
  - Mark the checkbox in the *Active* column.
  - Mark the checkbox in the *Trusted port* column.
- Open the *Advanced > DHCP L2 Relay > Configuration* dialog, *VLAN ID* tab.
- Specify the settings for VLAN 2 as follows:
  - Mark the checkbox in the *Active* column.
  - Mark the checkbox in the *Circuit ID* column.
  - To use the IP address of the device as the *Remote ID*, in the *Remote ID type* column, specify the value *ip*.
- To enable the function, select the *On* radio button in the *Operation* frame.
- Save the changes temporarily. To do this, click the  button.

Perform the following steps on Switch 2:

- Open the *Advanced > DHCP L2 Relay > Configuration* dialog, *Interface* tab.
- For port *1/1* and *1/2*, specify the settings as follows:
  - Mark the checkbox in the *Active* column.
  - Mark the checkbox in the *Trusted port* column.
- To enable the function, select the *On* radio button in the *Operation* frame.
- Save the changes temporarily. To do this, click the  button.



Verify that VLAN 2 is present. Then perform the following steps on Switch 1:

- Configure VLAN 2, and specify port 1/1 as a member of VLAN 2.

```
enable
vlan database
dhcp-l2relay circuit-id 2

dhcp-l2relay remote-id ip 2

dhcp-l2relay mode 2
exit
configure
interface 1/1

dhcp-l2relay mode
exit
interface 1/2

dhcp-l2relay trust
dhcp-l2relay mode
exit
dhcp-l2relay mode
```

Change to the Privileged EXEC mode.  
Change to the VLAN configuration mode.  
Activate the Circuit ID and the DHCP Option 82 on VLAN 2.  
Specify the IP address of the device as the Remote ID on VLAN 2.  
Activate the *DHCP L2 Relay* function on VLAN 2.  
Change to the Privileged EXEC mode.  
Change to the Configuration mode.  
Change to the interface configuration mode of interface 1/1.  
Activate the *DHCP L2 Relay* function on the port.  
Change to the Configuration mode.  
Change to the interface configuration mode of interface 1/2.  
Specify the port as *Trusted port*.  
Activate the *DHCP L2 Relay* function on the port.  
Change to the Configuration mode.  
Enable the *DHCP L2 Relay* function in the device.

Perform the following steps on Switch 2:

```
enable
configure
interface 1/1

dhcp-l2relay trust
dhcp-l2relay mode
exit
interface 1/2

dhcp-l2relay trust
dhcp-l2relay mode
exit
dhcp-l2relay mode
```

Change to the Privileged EXEC mode.  
Change to the Configuration mode.  
Change to the interface configuration mode of interface 1/1.  
Specify the port as *Trusted port*.  
Activate the *DHCP L2 Relay* function on the port.  
Change to the Configuration mode.  
Change to the interface configuration mode of interface 1/2.  
Specify the port as *Trusted port*.  
Activate the *DHCP L2 Relay* function on the port.  
Change to the Configuration mode.  
Enable the *DHCP L2 Relay* function in the device.

## 15.3 MRP-IEEE

The IEEE 802.1ak amendment to the IEEE 802.1Q standard introduced the Multiple Registration Protocol (MRP) to replace the Generic Attribute Registration Protocol (*GARP*). The IEEE also modified and replaced the *GARP* applications, *GARP* Multicast Registration Protocol (*GMRP*) and *GARP* VLAN Registration Protocol (*GVRP*), with the Multiple MAC Registration Protocol (*MMRP*) and the Multiple VLAN Registration Protocol (*MVRP*).

To confine traffic to the required areas of a network, the MRP applications distribute attribute values to MRP enabled devices across a LAN. The MRP applications register and de-register Multicast group memberships and VLAN identifiers.

**Note:** The Multiple Registration Protocol (MRP) requires a loop free network. To help prevent loops in your network, use a network protocol such as the Media Redundancy Protocol, Spanning Tree Protocol, or Rapid Spanning Tree Protocol with MRP.

### 15.3.1 MRP operation

Each participant contains an applicant component and an MRP Attribute Declaration (MAD) component. The applicant component is responsible for forming the attribute values and their registration and de-registration. The MAD component generates MRP messages for transmission and processes messages received from other participants. The MAD component encodes and transmits the attributes to other participants in MRP Data Units (MRPDU). In the switch, an MRP Attribute Propagation (MAP) component distributes the attributes to participating ports.

A participant exists for each MRP application and each LAN port. For example, a participant application exists on an end device and another application exists on a switch port. The Applicant state machine records the attribute and port for each MRP participant declaration on an end device or switch. Applicant state machine variable changes trigger the transmission of MRPDUs to communicate the declaration or withdrawal.

To establish an *MMRP* instance, an end device first sends a Join empty (JoinMt) message with the appropriate attributes. The switch then floods the JoinMt to the participating ports and to the neighboring switches. The neighboring switches flood the message to their participating port, and so on, establishing a path for the group traffic.

### 15.3.2 MRP timers

The default timer settings help prevent unnecessary attribute declarations and withdraws. The timer settings allow the participants to receive and process MRP messages before the Leave or LeaveAll timers expire.

When you reconfigure the timers, maintain the following relationships:

- ▶ To allow for re-registration after a Leave or LeaveAll event, although there is a lost message, set the value of the LeaveTime as follows:  $\geq (2x \text{JoinTime}) + 60$  in 1/100 s
- ▶ To minimize the volume of rejoining traffic generated following a LeaveAll, specify the value for the LeaveAll timer larger than the LeaveTime.

The following list contains various MRP events that the device transmits:

- ▶ Join - Controls the interval for the next Join message transmission
- ▶ Leave - Controls the length of time that a switch waits in the Leave state before changing to the withdraw state
- ▶ LeaveAll - Controls the frequency with which the switch generates LeaveAll messages

When expired, the Periodic timer initiates a Join request MRP message that the switch sends to participants on the LAN. The switches use this message to help prevent unnecessary withdraws.

### 15.3.3 MMRP

When a device receives Broadcast, Multicast or unknown traffic on a port, the device floods the traffic to the other ports. This process causes unnecessary use of bandwidth on the LAN.

The Multiple MAC Registration Protocol (*MMRP*) lets you control the traffic flooding by distributing an attribute declaration to participants on a LAN. The attribute values that the MAD component encodes and transmits on the LAN in MRP messages are Group service requirement information and 48-bit MAC addresses.

The switch stores the attributes in a filtering database as MAC address registration entries. The forwarding process uses the filtering database entries only to transmit data through those ports necessary to reach Group member LANs.

Switches facilitate the group distribution mechanisms based on the Open Host Group concept, receiving packets on the active ports and forwarding only to ports with group members. This way, any *MMRP* participants requiring packets transmitted to a particular group or groups, requests membership in the group. MAC service users send packets to a particular group from anywhere on the LAN. A group receives these packets on the LANs attached to registered *MMRP* participants. *MMRP* and the MAC Address Registration Entries thus restrict the packets to required segments of a loop-free LAN.

In order to maintain the registration and deregistration state and to receive traffic, a port declares interest periodically. Every device on a LAN with the *MMRP* function enabled maintains a filtering database and forwards traffic having the group MAC addresses to listed participants.

#### MMRP example

In this example, Host A intends to listen to traffic destined to group G1. Switch A processes the *MMRP* Join request received from host A and sends the request to both of the neighboring switches. The devices on the LAN now recognize that there is a host interested in receiving traffic destined for group G1. When Host B starts transmitting data destined for group G1, the data flows on the path of registrations and Host A receives it.

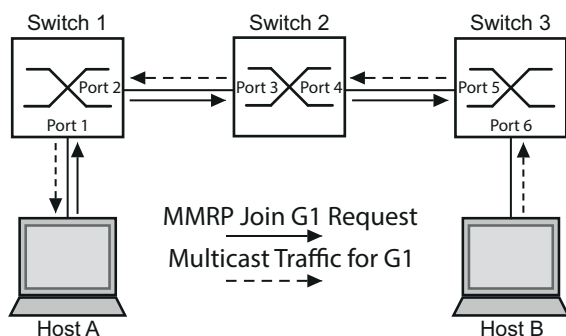

Figure 57: *MMRP* Network for MAC address Registration

Enable the *MMRP* function on the switches. To do this, perform the following steps:

- Open the *Switching > MRP-IEEE > MMRP* dialog, *Configuration* tab.
- To activate port 1 and port 2 as *MMRP* participants, mark the checkbox in the *MMRP* column for port 1 and port 2 on switch 1.
- To activate port 3 and port 4 as *MMRP* participants, mark the checkbox in the *MMRP* column for port 3 and port 4 on switch 2.
- To activate port 5 and port 6 as *MMRP* participants, mark the checkbox in the *MMRP* column for port 5 and port 6 on switch 3.
- To send periodic events allowing the device to maintain the registration of the MAC address group, enable the *Periodic state machine*. Select the *On* radio button in the *Configuration* frame.
- Save the changes temporarily. To do this, click the  button.

To enable the *MMRP* ports on switch 1, use the following commands. Substituting the appropriate interfaces in the commands, enable the *MMRP* functions and ports on switches 2 and 3.

<pre>enable configure interface 1/1  mrp-ieee mmrp operation interface 1/2  mrp-ieee mmrp operation exit mrp-ieee mrp periodic-state-machine mrp-ieee mmrp operation</pre>	<p>Change to the Privileged EXEC mode.</p> <p>Change to the Configuration mode.</p> <p>Change to the interface configuration mode of interface 1/1.</p> <p>Enabling the <i>MMRP</i> function on the port.</p> <p>Change to the interface configuration mode of interface 1/2.</p> <p>Enabling the <i>MMRP</i> function on the port.</p> <p>Change to the Configuration mode.</p> <p>Enabling the <i>Periodic state machine</i> function globally.</p> <p>Enabling the <i>MMRP</i> function globally.</p>
--	--

### 15.3.4 MVRP

The Multiple VLAN Registration Protocol (*MVRP*) is an MRP application that provides dynamic VLAN registration and withdraw services on a LAN.

The *MVRP* function provides a maintenance mechanism for the Dynamic VLAN Registration Entries, and for transmitting the information to other devices. This information lets *MVRP*-aware devices establish and update their VLAN membership information. When members are present on a VLAN, the information indicates through which ports the switch forwards traffic to reach those members.

The main purpose of the *MVRP* function is to allow switches to discover some of the VLAN information that you otherwise manually set up. Discovering this information lets switches overcome the limitations of bandwidth consumption and convergence time in large VLAN networks.

### MVRP example

Set up a network comprised of MVRP aware switches (1 - 4) connected in a ring topology with end device groups, A1, A2, B1, and B2 in 2 different VLANs, A and B. With STP enabled on the switches, the ports connecting switch 1 to switch 4 are in the discarding state, helping prevent a loop condition.

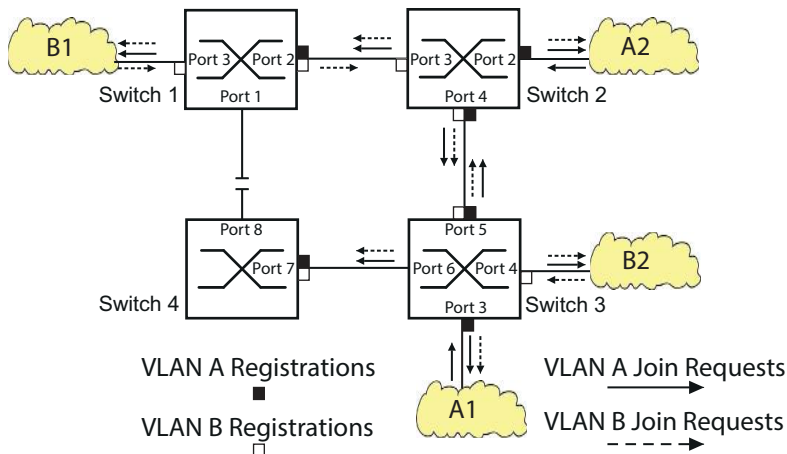

Figure 58: MVRP Example Network for VLAN Registration

In the MVRP example network, the LANs first send a Join request to the switches. The switch enters the VLAN registration in the forwarding database for the port receiving the frames.

The switch then propagates the request to the other ports, and sends the request to the neighboring LANs and switches. This process continues until the switches have registered the VLANs in the forwarding database of the receive port.

Enable MVRP on the switches. To do this, perform the following steps:

- Open the *Switching > MRP-IEEE > MVRP* dialog, *Configuration* tab.
- To activate the ports 1 through 3 as *MVRP* participants, mark the checkbox in the *MVRP* column for the ports 1 through 3 on switch 1.
- To activate the ports 2 through 4 as *MVRP* participants, mark the checkbox in the *MVRP* column for the ports 2 through 4 on switch 2.
- To activate the ports 3 through 6 as *MVRP* participants, mark the checkbox in the *MVRP* column for the ports 3 through 6 on switch 3.
- To activate port 7 and port 8 as *MVRP* participants, mark the checkbox in the *MVRP* column for port 7 and port 8 on switch 4.
- To maintain the registration of the VLANs, enable the *Periodic state machine*. Select the *On* radio button in the *Configuration* frame.
- To enable the function, select the *On* radio button in the *Operation* frame.
- Save the changes temporarily. To do this, click the  button.

To enable the *MVRP* ports on switch 1, use the following commands. Substituting the appropriate interfaces in the commands, enable the *MVRP* functions and ports on switches 2, 3 and 4.

```
enable
configure
interface 1/1
```

Change to the Privileged EXEC mode.

Change to the Configuration mode.

Change to the interface configuration mode of interface 1/1.

```
mrp-ieee mvrp operation
interface 1/2

mrp-ieee mvrp operation
exit

mrp-ieee mvrp periodic-state-machine
mrp-ieee mvrp operation
```

Enabling the *MVRP* function on the port.

Change to the interface configuration mode of interface *1/2*.

Enabling the *MVRP* function on the port.

Change to the Configuration mode.

Enabling the *Periodic state machine* function globally.

Enabling the *MVRP* function globally.



## 16 Industry Protocols

For a long time, automation communication and office communication were on different paths. The requirements and the communication properties were too different.

Office communication moves large quantities of data with low demands with respect to the transfer time. Automation communication moves small quantities of data with high demands with respect to the transfer time and availability.

While the transmission devices in the office are usually kept in temperature-controlled, relatively clean rooms, the transmission devices used in automation are exposed to wider temperature ranges. Dirty, dusty and damp ambient conditions make additional demands on the quality of the transmission devices.

With the continued development of communication technology, the demands and the communication properties have moved closer together. The high bandwidths now available in Ethernet technology and the protocols they support enable large quantities to be transferred and exact transfer times to be specified.

With the creation of the first optical LAN to be active worldwide, at the University of Stuttgart in 1984, Hirschmann laid the foundation for industry-compatible office communication devices. Thanks to Hirschmann's initiative with the world's first rail hub in the 1990s, Ethernet transmission devices such as switches, routers and firewalls are now available for the toughest automation conditions.

The desire for uniform, continuous communication structures encouraged many manufacturers of automation devices to come together and use standards to aid the progress of communication technology in the automation sector. This is why we now have protocols that enable us to communicate via Ethernet from the office right down to the field level.

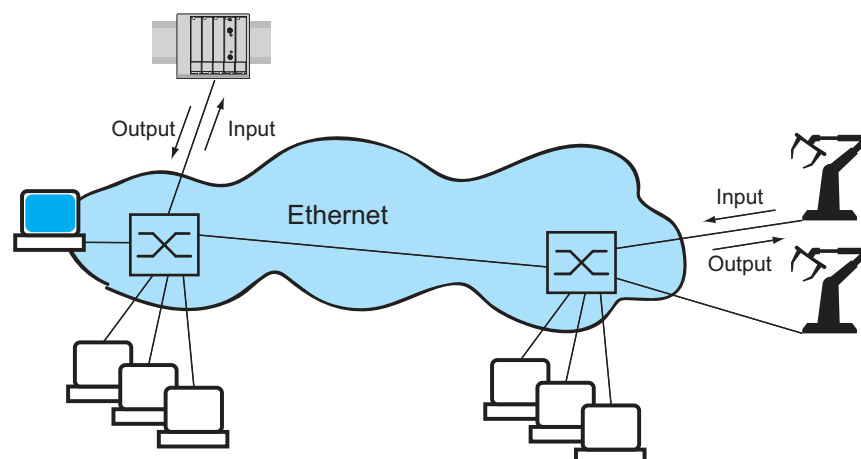

Figure 59: Example of communication.



## 16.1 IEC 61850/MMS

IEC 61850/MMS is an industrial communication protocol standardized by the International Electrotechnical Commission (IEC). The protocol is to be found in substation automation, for example in the control technology of energy suppliers.

This protocol, which works in a packet-oriented way, is based on the TCP/IP transport protocol and uses the Manufacturing Messaging Specification (MMS) for the client-server communication. The protocol is object-oriented and defines a standardized configuration language that comprises, among other things, functions for SCADA, Intelligent Electronic Devices (IED) and for the network control technology.

Part 6 of the IEC 61850 standard defines the configuration language SCL (Substation Configuration Language). SCL describes the properties of the device and the system structure in an automatically processable form. The properties of the device described with SCL are stored in the ICD file in the device.

### 16.1.1 Switch model for IEC 61850

The Technical Report, IEC 61850 90-4, specifies a bridge model. The bridge model represents the functions of a switch as objects of an Intelligent Electronic Device (IED). An MMS client (for example the control room software) uses these objects to monitor and configure the device.

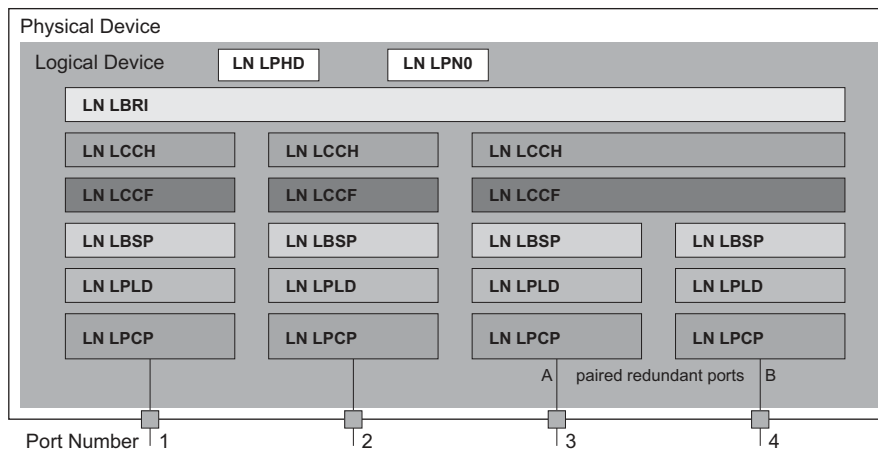

Figure 60: Bridge model based on Technical Report IEC 61850 90-4

Table 38: Classes of the bridge model based on TR IEC61850 90-4

Class	Description
LN LLN0	Zero logical node of the Bridge IED: Defines the logical properties of the device.
LN LPHD	Physical Device logical node of the Bridge IED: Defines the physical properties of the device.
LN LBRI	Bridge logical node: Represents general settings of the bridge functions of the device.
LN LCCH	Communication Channel logical node: Defines the logical Communication Channel that consists of one or more physical device ports.

Table 38: Classes of the bridge model based on TR IEC61850 90-4 (cont.)

Class	Description
LN LCCF	<a href="#">Channel Communication Filtering</a> logical node: Defines the VLAN and Multicast settings for the higher-level <a href="#">Communication Channel</a> .
LN LBSP	<a href="#">Port Spanning Tree Protocol</a> logical node: Defines the Spanning Tree statuses and settings for the respective physical device port.
LN LPLD	<a href="#">Port Layer Discovery</a> logical node: Defines the LLDP statuses and settings for the respective physical device port.
LN LPCP	<a href="#">Physical Communication Port</a> logical node: Represents the respective physical device port.

## 16.1.2 Integration into a Control System

### Preparation of the device

Perform the following steps:

- Check that the device has an IP address assigned.
- Open the [Advanced > Industrial Protocols > IEC61850-MMS](#) dialog.
- To start the MMS server, select in the [Operation](#) frame the *On* radio button, and click  button. Afterwards, an MMS client is able to connect to the device and to read and monitor the objects defined in the bridge model.

### NOTICE

#### RISK OF UNAUTHORIZED ACCESS TO THE DEVICE

IEC61850/MMS does not provide any authentication mechanisms. If the write access for IEC61850/MMS is activated, then every client that can access the device using TCP/IP is capable of changing the settings of the device. This in turn can result in an incorrect configuration of the device and to failures in the network.

Only activate the write access if you have taken additional measures (for example Firewall, VPN, etc.) to reduce possible unauthorized access.

**Failure to follow these instructions can result in equipment damage.**

- To allow the MMS client to change the settings, mark the [Write access](#) checkbox, and click the  button.

### Offline configuration

The device lets you download the ICD file using the Graphical User Interface. This file contains the properties of the device described with SCL and enables you to configure the substation without directly connecting to the device.

- Open the [Advanced > Industrial Protocols > IEC61850-MMS](#) dialog.
- To load the ICD file to your PC, click the  button and then the [Download](#) item.

## Monitoring the device

The IEC61850/MMS server integrated into the device lets you monitor multiple statuses of the device by means of the Report Control Block (RCB). Up to 5 MMS clients can register for a Report Control Block at the same time.

The device lets you monitor the following statuses:

Table 39: Statuses of the device that can be monitored with IEC 61850/MMS

Class	RCB object	Description
LN LPHD	TmpAlm	When the temperature measured in the device exceeds or falls below the set temperature thresholds, the status changes.
	PhyHealth	When the status of the <code>LPHD.TmpAlm</code> RCB object changes, the status changes.
LN LPHD	TmpAlm	When the temperature measured in the device exceeds or falls below the set temperature thresholds, the status changes.
	PwrSupAlm	When one of the redundant power supplies fails or starts operating again, the status changes.
	PhyHealth	When the status of the <code>LPHD.PwrSupAlm</code> or <code>LPHD.TmpAlm</code> RCB object changes, the status changes.
LN LBRI	RstpRoot	When the device takes over or relinquishes the role of the root bridge, the status changes.
	RstpTopoCnt	When the topology changes due to a change of the root bridge, the status changes.
LN LCCH	ChLiv	When the link status of the physical port changes, the status changes.
LN LPCP	PhyHealth	When the link status of the physical port changes, the status changes.

## 16.2 Modbus TCP

*Modbus TCP* is an application layer messaging protocol providing client/server communication between the client and devices connected in Ethernet TCP/IP networks.

The *Modbus TCP* function lets you install the device in networks already using *Modbus TCP* and retrieve information saved in the registers in the device.

### 16.2.1 Client/Server Modbus TCP/IP Mode

The device supports the client/server model of Modbus TCP/IP. This device operates as a server in this constellation and responds to requests from a client for information saved in the registers.

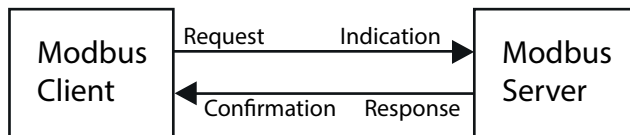

Figure 61: Client/Server Modbus TCP/IP Mode

The client / server model uses four types of messages to exchange data between the client and server:

- ▶ Modbus TCP/IP Request, the client creates a request for information and sends it to the server.
- ▶ Modbus TCP/IP Indication, the server receives a request as an indication that a client requires information.
- ▶ Modbus TCP/IP Response, when the required information is available, the server sends a reply containing the requested information. When the requested information is unavailable, the server sends an Exception Response to notify the client of the error detected during the processing. The Exception Response contains an exception code indicating the reason for the detected error.
- ▶ Modbus TCP/IP Confirmation, the client receives a response from the server, containing the requested information.

### 16.2.2 Supported Functions and Memory Mapping

The device supports functions with the public codes `0x03` ([Read Holding Registers](#)) and `0x05` ([Write Single Coil](#)). The codes let you read the information saved in the registers such as the system information, including the system name, system location, software version, IP address, MAC address. The codes also let you read the port information and port statistics. The `0x05` code lets you reset the port counters individually or globally.

The following list contains definitions for the values entered in the [Format](#) column:

- ▶ Bitmap: a group of 32-bits, encoded into the Big-endian byte order and saved in 2 registers. Big-endian systems save the most significant byte of a word in the smallest address and save the least significant byte in the largest address.
- ▶ F1: 16-bit unsigned integer
- ▶ F2: Enumeration - power supply alarm
  - 0 = power supply good
  - 1 = power supply failure detected
- ▶ F3: Enumeration - OFF/ON
  - 0 = Off
  - 1 = On

- ▶ F4: Enumeration - port type
  - 0 = Giga - Gigabit Interface Converter (GBIC)
  - 1 = Copper - Twisted Pair (TP)
  - 2 = Fiber - 10 Mb/s
  - 3 = Fiber - 100 Mb/s
  - 4 = Giga - 10/100/1000 Mb/s (triple speed)
  - 5 = Giga - Copper 1000 Mb/s TP
  - 6 = Giga - Small Form-factor Pluggable (SFP)
- ▶ F9: 32-bit unsigned long
- ▶ String: octets, saved in sequence, 2 octets per register.

### Modbus TCP/IP Codes

The table below lists addresses that allow the client to reset port counters and retrieve specific information from the device registers.

### Port Information

Table 40: Port Information

Address	Qty	Description	Min	Max	Step	Unit	Format
0400	1	Port 1 Type	0	6	1	-	F4
0401	1	Port 2 Type	0	6	1	-	F4
		...					
043F	1	Port 64 Type	0	6	1	-	F4
0440	1	Port 1 Link Status	0	1	1	-	F1
0441	1	Port 2 Link Status	0	1	1	-	F1
		...					
047F	1	Port 64 Link Status	0	1	1	-	F1
0480	1	Port 1 STP State	0	1	1	-	F1
0481	1	Port 2 STP State	0	1	1	-	F1
		...					
04BF	1	Port 64 STP State	0	1	1	-	F1
04C0	1	Port 1 Activity	0	1	1	-	F1
04C1	1	Port 2 Activity	0	1	1	-	F1
		...					
04FF	1	Port 64 Activity	0	1	1	-	F1
0500	1	Port 1 Counter Reset	0	1	1	-	F1
0501	1	Port 2 Counter Reset	0	1	1	-	F1
		...					
053F	1	Port 64 Counter Reset	0	1	1	-	F1

## Port Statistics

Table 41: Port Statistics

Address	Qty	Description	Min	Max	Step	Unit	Format
0800	1	Port1 - Number of bytes received	0	4294967295	1	-	F9
0802	1	Port1 - Number of bytes sent	0	4294967295	1	-	F9
0804	1	Port1 - Number of frames received	0	4294967295	1	-	F9
0806	1	Port1 - Number of frames sent	0	4294967295	1	-	F9
0808	1	Port1 - Total bytes received	0	4294967295	1	-	F9
080A	1	Port1 - Total frames received	0	4294967295	1	-	F9
080C	1	Port1 - Number of broadcast frames received	0	4294967295	1	-	F9
080E	1	Port1 - Number of multicast frames received	0	4294967295	1	-	F9
0810	1	Port1 - Number of frames with CRC error	0	4294967295	1	-	F9
0812	1	Port1 - Number of oversized frames received	0	4294967295	1	-	F9
0814	1	Port1 - Number of bad fragments rcvd(<64 bytes)	0	4294967295	1	-	F9
0816	1	Port1 - Number of jabber frames received	0	4294967295	1	-	F9
0818	1	Port1 - Number of collisions occurred	0	4294967295	1	-	F9
081A	1	Port1 - Number of late collisions occurred	0	4294967295	1	-	F9
081C	1	Port1 - Number of 64-byte frames rcvd/sent	0	4294967295	1	-	F9
081E	1	Port1 - Number of 65-127 byte frames rcvd/sent	0	4294967295	1	-	F9
0820	1	Port1 - Number of 128-255 byte frames rcvd/sent	0	4294967295	1	-	F9
0822	1	Port1 - Number of 256-511 byte frames rcvd/sent	0	4294967295	1	-	F9
0824	1	Port1 - Number of 512-1023 byte frames rcvd/sent	0	4294967295	1	-	F9
0826	1	Port1 - Number of 1023-MAX byte frames rcvd/sent	0	4294967295	1	-	F9
0828	1	Port1 - Number of Mac Error Packets	0	4294967295	1	-	F9
082A	1	Port1 - Number of dropped received packets	0	4294967295	1	-	F9
082C	1	Port1 - Number of multicast frames sent	0	4294967295	1	-	F9
082E	1	Port1 - Number of broadcast frames sent	0	4294967295	1	-	F9
0830	1	Port1 - Number of <64 byte fragments w/ good CRC	0	4294967295	1	-	F9
		...					
147E	1	Port64 - Number of <64 byte fragments w/ good CRC	0	4294967295	1	-	F9

### 16.2.3 Example Configuration

In this example, you configure the device to respond to client requests. The prerequisite for this configuration is that the client device is configured with an IP address within the given range. The [Write access](#) function remains inactive for this example. When you activate the [Write access](#) function, the device lets you reset the port counters only. In the default configuration the [Modbus TCP](#) and [Write access](#) functions are inactive.

**NOTICE**

**RISK OF UNAUTHORIZED ACCESS TO THE DEVICE**

The [Modbus TCP](#) protocol does not provide any authentication mechanisms. If the write access for [Modbus TCP](#) is activated, then every client that can access the device using TCP/IP is capable of changing the settings of the device. This in turn can result in an incorrect configuration of the device and to failures in the network.

Only activate the write access if you have taken additional measures (for example Firewall, VPN, etc.) to reduce possible unauthorized access.

**Failure to follow these instructions can result in equipment damage.**

Perform the following steps:

- Open the [Device Security > Management Access > IP Access Restriction](#) dialog.
- To add a table entry, click the  button.
- Specify the IP address range, in [Index row 2](#), enter 10.17.1.0/29 in the [IP address range](#) column.
- Verify that the [Modbus TCP](#) function is enabled.
- To activate the range, mark the [Active](#) checkbox.
- Open the [Diagnostics > Status Configuration > Security Status](#) dialog, [Global](#) tab.
- Verify that the [Modbus TCP active](#) checkbox is marked.
- Open the [Advanced > Industrial Protocols > Modbus TCP](#) dialog.
- The standard [Modbus TCP](#) listening port, port 502, is the default value. However, when you wish to listen on another TCP port, enter the value for the listening port in the [TCP port](#) field.
- To enable the function, select the [On](#) radio button in the [Operation](#) frame.

When you enable the [Modbus TCP](#) function, the [Security Status](#) function detects the activation and displays an alarm in the [Basic Settings > System](#) dialog, [Security status](#) frame.

enable	Change to the Privileged EXEC mode.
network management access add 2	Creates the entry for the address range in the network. Number of the next available index in this example: 2.
network management access modify 2 ip 10.17.1.0	Specifies the IP address.
network management access modify 2 mask 29	Specifies the netmask.
network management access modify 2 modbus-tcp enable	Specifies that the device lets <a href="#">Modbus TCP</a> have access to the device management.
network management access operation	Enables the IP access restriction.

```

configure
security-status monitor modbus-tcp-
enabled

modbus-tcp operation

modbus-tcp port <1..65535>

show modbus-tcp

Modbus TCP/IP server settings
-----
Modbus TCP/IP server operation.....enabled
Write-access.....disabled
Listening port.....502
Max number of sessions.....5
Active sessions.....0

show security-status monitor

Device Security Settings
Monitor
-----
Password default settings unchanged.....monitored
...
Write access using HiDiscovery is possible...monitored
Loading unencrypted configuration from ENVM...monitored
IEC 61850 MMS is enabled.....monitored
Modbus TCP/IP server active.....monitored

show security-status event

Time stamp          Event                      Info
-----
2014-01-01 01:00:39 password-change(10)         -
.....
2014-01-01 01:00:39 ext-nvm-load-unsecure(21)  -
2014-01-01 23:47:40 modbus-tcp-enabled(23)     -

show network management access rules 1

Restricted management access settings
-----
Index.....1
IP Address.....10.17.1.0
Prefix Length.....29
HTTP.....yes
SNMP.....yes
Telnet.....yes
SSH.....yes
HTTPS.....yes
IEC61850-MMS.....yes
Modbus TCP/IP.....yes
Active.....[x]

```

Change to the Configuration mode.

Specifies that the device monitors the activation of the *Modbus TCP* server.

Activates the *Modbus TCP* server.

Specify the TCP port for *Modbus TCP* communication (optionally). The default value is port 502.

Display the *Modbus TCP* Server settings.

Display the security-status settings.

Display occurred security status events.

Display the restricted management access rules for index 1.



## 16.3 EtherNet/IP

*EtherNet/IP* is accepted worldwide as a standardized industrial communication protocol and is maintained by the Open DeviceNet Vendor Association (ODVA). The protocol is based on the widely used standard Ethernet transport protocols TCP/IP and UDP/IP. *EtherNet/IP* is supported by leading manufacturers, thus providing a wide base for effective data communication in the industry sector.

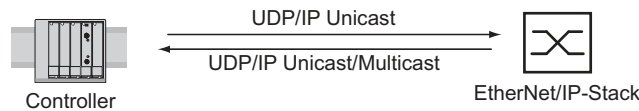

Figure 62: *EtherNet/IP* network

*EtherNet/IP* adds the industry protocol CIP (Common Industrial Protocol) to the standard Ethernet protocols. *EtherNet/IP* implements CIP at the Session layer and above and adapts CIP to the specific *EtherNet/IP* technology at the Transport layer and below. In the case of automation applications, *EtherNet/IP* implements CIP on the application level. Therefore, *EtherNet/IP* is ideally suited to the industrial control technology sector.

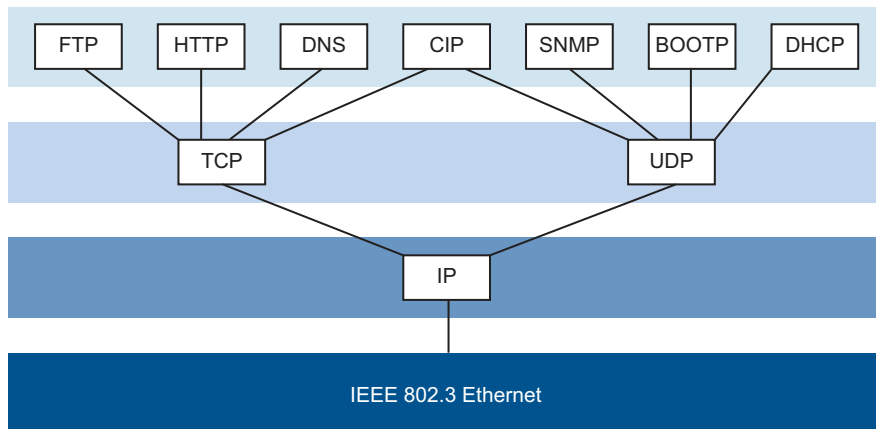

Figure 63: *IEEE802.3 EtherNet/IP*

In particular, you find *EtherNet/IP* in the USA and in conjunction with Rockwell controllers.

For detailed information on *EtherNet/IP*, see the ODVA website at [www.odva.org/Home/ODVATECHNOLOGIES/EtherNetIP.aspx](http://www.odva.org/Home/ODVATECHNOLOGIES/EtherNetIP.aspx).

### 16.3.1 Integration into a Control System

Perform the following steps:

- Open the *Switching > IGMP Snooping > Global* dialog. Verify that the *IGMP Snooping* function is enabled.

- Open the *Advanced > Industrial Protocols > EtherNet/IP* dialog. Verify that the *EtherNet/IP* function is enabled.
- Open the *Advanced > Industrial Protocols > EtherNet/IP* dialog.
- To save the EDS as a ZIP archive on your PC, click *Download*. The ZIP archive contains the *EtherNet/IP* configuration file and the icon used to configure the controller to connect to the device.

**Note:** If *EtherNet/IP* and the *Routing* function are enabled at the same time, then malfunctions are possible with *EtherNet/IP* for example, in connection with “RS Who”. Therefore, if the *Routing* function is active, then disable the *Routing* function in the device.

- To disable the routing function in the device, open the *Routing > Global* dialog.
- In the *Operation* frame, select the *OFF* radio button.
- Save the changes temporarily. To do this, click the  button.

Disable the *Routing* function. To do this, perform the following steps:

enable	Change to the Privileged EXEC mode.
configure	Change to the Configuration mode.
no ip routing	Deactivate the <i>Routing</i> function in the device.

### Configuration of a PLC using the example of Rockwell software

Perform the following steps:

- Open the “EDS Hardware Installation Tool” of RSLinx.
- Use the “EDS Hardware Installation Tool” to add the EDS file.
- Restart the “RSLinx” service so that RSLinx takes over the EDS file of the device.
- Use RSLinx to check if RSLinx has detected the device.

- Open your Logix 5000 project.
- Integrate the device into the Ethernet port of the controller as a new module (Generic Ethernet Module).

Table 42: Settings for integrating a Generic Ethernet Module

Setting	I/O connection	Input only	Listen only
Comm Format	Data - DINT	Data - DINT	Input data - DINT - Run/Program
IP Address	IP address of the device	IP address of the device	IP address of the device
Input Assembly Instance	2	2	2
Input Size	7	7	7
Output Assembly Instance	1	254	255
Output Size	1	0	0
Configuration Assembly Instance	3	3	3
Configuration Size	0	0	0

- In the module properties, enter a value of at least 100 ms for the Request Packet Interval (RPI).

**Note:** Monitoring the I/O connection to the CPU of the device as a failure can result in a system failure. Therefore, monitoring the I/O connection as a failure criterion is less suitable.

The I/O connection between the programmable logic controller (PLC) and the device can be interrupted by a management program. For example, a management station can saturate the CPU of the device with higher priority Real Time (RT) data. In this case, the device can still transmit or receive data packets and the system remains operational.

### Example of integration from the Sample Code Library

The Sample Code Library is a website from Rockwell. The object of the website is to provide users with a place where they can exchange their best architecture integration applications.

On the website [samplecode.rockwellautomation.com](http://samplecode.rockwellautomation.com), search for catalog number 9701. This is the catalog number of an example for integrating the Hirschmann device into RS Logix 5000 rel. 16, PLC firmware release 16.

## 16.3.2 EtherNet/IP Entity Parameters

The following paragraphs identify the objects and operations supported by the device.

## Supported operations

Table 43: Overview of the supported EtherNet/IP requests for the objects instances

Service Code	Identity Object	TCP/IP Interface Object	Ethernet Link Object	Switch Agent Object	Base Switch Object	DLR Object
0x01 Get Attribute All	All attributes	All attributes	All attributes	All attributes	All attributes	All attributes (except attribute 0x9) <sup>1</sup>
0x02 Set Attribute All	–	Settable attributes (0x3, 0x5, 0x6, 0x8, 0x9, 0xA)	Settable attributes (0x6, 0x9)	–	–	–
0x0e Get Attribute Single	All attributes	All attributes	All attributes	All attributes	All attributes	All attributes
0x10 Set Attribute Single	–	Settable attributes (0x3, 0x5, 0x6, 0x8, 0x9, 0xA, 0x64)	Settable attributes (0x6, 0x9, 0x65, 0x67, 0x68, 0x69, 0x6C)	Settable attributes (0x5, 0x7)	–	Settable attributes (0x4, 0x5)
0x05 Reset	Parameter (0x0, 0x1)	–	–	–	–	–
0x35 Save Configuration Vendor specific	–	–	–	Save switch configuration	–	–
0x36 Mac Filter Vendor specific	–	–	–	Add MAC filter STRUCT of: USINT VlanId ARRAY of: 6 USINT Mac DWORD PortMask	–	–
0x4B Verify Fault Location						Verify fault location
0x4C Clear Rapid Faults						Clear rapid faults
0x4D Restart Sign On						Restart Sign On
0x04E Clear Gateway Partial Fault						Clear Gateway Partial Fault

1. The DLR participants list (attribute 0x9) is not included in the Get Attribute All service. Read it using the Get Attribute Single service.

### Identity object

The device supports the identity object (Class Code 0x01) of *EtherNet/IP*. The Hirschmann manufacturer ID is 634. Hirschmann uses the ID 44 (0x2C) to indicate the product type "Managed Ethernet Switch".

Table 44: Instance attributes (only instance 1 is available)

Id	Attribute	Access Rule	Data type	Description
0x1	Vendor ID	Get	UINT	Hirschmann634
0x2	Device Type	Get	UINT	Managed Ethernet Switch 44 (0x2C) (0x2C)
0x3	Product Code	Get	UINT	Product Code: mapping is defined for every device type
0x4	Revision	Get	STRUCT of: USINT Major USINT Minor	Revision of the EtherNet/IP implementation, 2.1.
0x5	Status	Get	WORD	Support for the following Bit status only: 0: Owned (always 1) 2: Configured (always 1) 4: Extend Device Status 5: 0x3: No I/O connection established 6: 0x7: At least one I/O connection established, 7: all in idle mode.
0x6	Serial number	Get	UDINT	Serial number of the device (contains last 3 Bytes of MAC address).
0x7	Product name	Get	SHORT-STRING	Displayed as "Hirschmann" + product family + product ID + software variant.

### TCP/IP Interface Object

The device supports only Instance 1 of the TCP/IP Interface Object (Class Code 0xF5) of *EtherNet/IP*.

Depending on the write access status, the device stores the complete configuration in its flash memory. Saving the configuration file can take up to 10 seconds. If the saving process is interrupted for example, due to a power supply failure, then the operation of the device might be impossible.

**Note:** The device replies to the configuration change *Get Request* with a *Response* although the configuration has not yet been saved completely.

Table 45: Class attributes

Id	Attribute	Access Rule	Data type	Description
0x1	Revision	Get	UINT	Revision of this object: 3
0x2	Max Instance	Get	UINT	Maximum instance number: 1
0x3	Number of instance	Get	UINT	Number of object instances currently created: 1

Table 46: Attributes of Instance 1

Id	Attribute	Access Rule	Data type	Description
0x1	Status	Get	DWORD	0: Interface Status (0=Interface not configured, 1=Interface contains valid config) 6: ACD status (default 0) 7: ACD fault (default 0)
0x2	Interface Capability flags	Get	DWORD	0: BOOTP Client 1: DNS Client 2: DHCP Client 3: DHCP-DNS Update 4: Configuration settable (within CIP) Other bits reserved (0) 7: ACD capable (0=not capable, 1=capable)
0x3	Config Control	Set/Get	DWORD	0: 0x0=using stored config 1: 0x1=using BOOTP 2: 0x2=using DHCP 3: 4: One device uses DNS for name lookup (always 0 because it is not supported) Other bits reserved (0)
0x4	Physical Link Object	Get	STRUCT of: UINT PathSize EPATH Path	Path to the Physical Link Object, always {0x20, 0xF6, 0x24, 0x01} describing instance 1 of the Ethernet Link Object.
0x5	Interface Configuration	Set/Get	STRUCT of: UDINT IpAddress UDINT Netmask UDINT GatewayAddress UDINT NameServer1 UDINT NameServer2 STRING DomainName	IP Stack Configuration (IP- Address, Netmask, Gateway, 2 Name servers (DNS, if supported) and the domain name).
0x6	Host Name	Set/Get	STRING	Host Name (for DHCP DNS Update)
0x7	Safety Network Number			Not supported
0x8	TTL Value	Get/Set	USINT	Time to live value for IP multicast packets Range 1..255 (default = 1)

Table 46: Attributes of Instance 1 (cont.)

Id	Attribute	Access Rule	Data type	Description
0x9	Mcast Config	Get/Set	STRUCT of: USINT AllocControl USINT reserved UINT NumMcast UDINT McastStartAddr	Alloc Control = 0 Number of IP multicast addresses = 32 Multicast start address = 239.192.1.0
0xA	Selected Acd	Get/Set	BOOL	0=ACD disable 1=ACD enable (default)
0xB	Last Conflict Detected	Get	STRUCT of: USINT AcdActivity ARRAY of: 6 USINT RemoteMac ARRAY of: 28 USINT ArpPdu	ACD Diagnostic Parameters

Table 47: Hirschmann extensions to the TCP/IP Interface Object

Id	Attribute	Access Rule	Data type	Description
0x6 4	Cable Test	Set/Get	STRUCT of: USINT Interface USINT Status	Interface Status (1=Active, 2=Success, 3=Failure, 4=Uninitialized)
0x6 5	Cable Pair Size	Get	USINT	Size of the Cable Test Result STRUCT of: 2 Pair for 100BASE 4 Pair for 1000BASE

Table 47: Hirschmann extensions to the TCP/IP Interface Object (cont.)

Id	Attribute	Access Rule	Data type	Description
0x66	Cable Test Result	Get	STRUCT of: USINT Interface USINT CablePair USINT CableStatus USINT CableMinLength USINT CableMaxLength USINTCableFailureLocation	100BASE: {Interface, CablePair1, CableStatus, CableMinLength, CableMaxLength, CableFailureLocation} 1000BASE: {Interface, CablePair1, CableStatus, CableMinLength, CableMaxLength, CableFailureLocation} {Interface, CablePair2, CableStatus, CableMinLength, CableMaxLength, CableFailureLocation} {Interface, CablePair3, CableStatus, CableMinLength, CableMaxLength, CableFailureLocation} {Interface, CablePair4, CableStatus, CableMinLength, CableMaxLength, CableFailureLocation}

### Ethernet Link object

Specify at least one instance in the device, for example, Instance 1 is the CPU Ethernet interface instance (Class Code 0xF6) of [EtherNet/IP](#).

Table 48: Instance attributes

Id	Attribute	Access Rule	Data type	Description
0x1	Interface Speed	Get	UDINT	Used interface speed in MBit/s (10, 100, 1000, ...). 0 is used when the speed has not been determined or is invalid because of detected errors.



Table 48: Instance attributes (cont.)

Id	Attribute	Access Rule	Data type	Description
0x2	Interface Flags	Get	DWORD	Interface Status Flags: 0: Link State (0=No link, 1=Link) 1: Duplex mode (0=Half, 1=Full) 2: Auto-Negotiation Status 3: 0x0=Auto-Negotiation in progress 0x1=Auto-Negotiation failed 4: 0x2=Failed but speed detected 0x3=Auto-Negotiation success 0x4=No Auto-Negotiation 5: Manual configuration require reset (always 0 because it is not needed) 6: Hardware error
0x3	Physical Address	Get	ARRAY of: 6 USINT	MAC address of physical interface
0x4	Interface Counters	Get	STRUCT of: UDINT MibIICounter1 UDINT MibIICounter2 ...	InOctets, InUcastPackets, InNUcastPackets, InDiscards, InErrors, InUnknownProtos, OutOctets, OutUcastPackets, OutNUcastPackets, OutDiscards, OutErrors
0x5	Media Counters	Get	STRUCT of: UDINT EthernetMib Counter1 UDINT EthernetMib Counter2 ...	Alignment Errors, FCS Errors, Single Collision, Multiple Collision, SQE Test Errors, Deferred Transmissions, Late Collisions, Excessive Collisions, MAC TX Errors, Carrier Sense Errors, Frame Too Long, MAC RX Errors
0x6	Interface Control	Get/Set	STRUCT of: WORD ControlBits UINT ForcedInterface Speed	Control Bits: 0: Auto-negotiation enable/disable (0=disable, 1=enable) 1: Duplex mode (0=Half, 1=Full), if Auto-negotiation disabled Interface speed in MBits/s: 10,100,..., if Auto-negotiation disabled
0x7	Interface type	Get	USINT	Type of interface: 0: Unknown interface type 1: The interface is internal 2: Twisted-pair 3: Optical fiber

Table 48: Instance attributes (cont.)

Id	Attribute	Access Rule	Data type	Description
0x8	Interface state	Get	USINT	Current state of the interface: 0: Unknown interface state 1: The interface is enabled 2: The interface is disabled 3: The interface is testing
0x9	Admin State	Set/Get	USINT	Administrative state: 1: Enable the interface 2: Disable the interface
0xA	Interface label	Get	SHORT-STRING	Human readable ID

Table 49: Hirschmann extensions to the Ethernet Link Object

Id	Attribute	Access Rule	Data type	Description
0x6 4	Ethernet Interface Index	Get	USINT	Interface/Port Index (ifIndex out of MIBII)
0x6 5	Port Control	Get/Set	DWORD	0: Link state (0=link down, 1=link up) 1: Link admin state (0=disabled, 1=enabled) 8: Access violation alarm (read-only) 9: Utilization alarm (read-only)
0x6 6	Interface Utilization	Get	USINT	The existing Counter out of the private MIB hm2IDiagfaceUtilization is used. Utilization in percentage (Unit 1%=100, %/100). RX Interface Utilization.
0x6 7	Interface Utilization Alarm Upper Threshold	Get/Set	USINT	Within this parameter the variable hm2DiagIfaceUtilizationAlarmUpperT hreshold can be accessed. Utilization in percentage (Unit 1%=100). RX Interface Utilization Upper Limit.
0x6 8	Interface Utilization Alarm Lower Threshold	Get/Set	USINT	Within this parameter the variable hm2DiagIfaceUtilizationAlarmLowerT hreshold can be accessed. Utilization in percentage (Unit 1%=100). RX Interface Utilization Lower Limit.
0x6 9	Broadcast limit	Get/Set	USINT	Broadcast limiter Service (Egress BC-Frames limitation, 0=disabled), Frames/second
0x6 A	Ethernet Interface Description	Get/Set	STRING	Interface/Port Description (from MIB II ifDescr), for example "Unit: 1 Slot: 2 Port: 1 - 10/100 Mbit TX" or "unavailable", max. 64 Bytes.

Table 49: Hirschmann extensions to the Ethernet Link Object (cont.)

Id	Attribute	Access Rule	Data type	Description
0x6 B	Port Monitor	Get/Set	DWORD	0: Link Flap (0=Off, 1=On) 1: CRC/Fragment (0=Off, 1=On) 2: Duplex Mismatch (0=Off, 1=On) 3: Overload-Detection (0=Off, 1=On) 4: Link-Speed/ Duplex Mode (0=Off, 1=On) 5: Deactivate port action (0=Off, 1=On) 6: Send trap action (0=Off, 1=On) 7: Active Condition (displays which 8: condition caused an action to occur) 9: 00001 <sub>B</sub> : Link Flap 10 00010 <sub>B</sub> : CRC/Fragments : 00100 <sub>B</sub> : Duplex Mismatch 11 01000 <sub>B</sub> : Overload-Detection : 10000 <sub>B</sub> : Link-Speed/ Duplex mode 12 Reserved (always 0) : 13 Reserved (always 0) : 14 Reserved (always 0) : 15 Reserved (always 0) :
0x6 C	Quick Connect	Get/Set	USINT	Quick Connect on the interface (0=Off, 1=On) If you enable Quick Connect, then the device sets the port speed to 100FD, disables Auto-Negotiation, and Spanning Tree on the interface.
0x6 D	SFP Diagnostics	Get	STRUCT of:	STRING ModuleType SHORT-STRING SerialNumber USINT Connector USINT Supported DINT Temperature in °C DINT TxPower in mW DINT RxPower in mW DINT RxPower in dBm DINT TxPower in dBm

Table 50: Assignment of ports to Ethernet Link Object Instances

Ethernet Port	Ethernet Link Object Instance
CPU	1
Module 1 / Port 1	2
Module 1 / Port 2	3
Module 1 / Port 3	4
Module 1 / Port 4	5
...	...

**Note:** The number of ports depends on the type of hardware used. The Ethernet Link Object only exists, if the module is plugged in and the port is connected.

### **Switch Agent object**

The device supports the Hirschmann specific Ethernet Switch Agent Object (Class Code 0x95) for the device configuration and information parameters with Instance 1.

Table 51: Class attributes

Id	Attribute	Access Rule	Data type	Description
0x1	Switch Status	Get	DWORD	0: Like the signal contact, the value indicates the Device Overall state (0=ok, 1=failed) 1: Device Security Status (0=ok, 1=failed) 2: Power Supply 1 (0=ok, 1=failed) 3: Power Supply 2 (0=ok, 1=failed or not existing) 4: Reserved 5: Reserved 6: Signal Contact 1 (0=closed, 1=open) 7: Signal Contact 2 (0=closed, 1=open or not existing) 8: Reserved 9: Temperature (0=ok, 1=failure) 10: Module removed (1=removed) 11: ACA21/ACA22 removed (1=removed) 12: ACA31 removed (1=removed) 13: Reserved 14: Reserved 15: Reserved 16: Reserved 17: Reserved 18: Reserved 19: Reserved 20: Reserved 21: Reserved 22: Reserved 23: MRP (0=disabled, 1=enabled) 24: PRP (0=disabled, 1=enabled) 25: HSR (0=disabled, 1=enabled) 26: RSTP (0=disabled, 1=enabled) 27: LAG (0=disabled, 1=enabled) 28: DLR (0=disabled, 1=enabled) 29: Reserved 30: Reserved 31: Connection Error (1=failure)

Table 51: Class attributes (cont.)

Id	Attribute	Access Rule	Data type	Description
0x2	Switch Temperature	Get	STRUCT of: INT TemperatureF INT TemperatureC	in °F in °C
0x3	Reserved	Get	UDINT	Reserved for future use (always 0)
0x4	Switch Max Ports	Get	UINT	Maximum number of Ethernet Switch Ports
0x5	Multicast Settings (IGMP Snooping)	Get/Set	WORD	0: IGMP Snooping (0=disabled, 1=enabled) 1: IGMP Querier (0=disabled, 1=enabled) 2: IGMP Querier Mode (read-only) (0=Non-Querier, 1=Querier) 3: 4: IGMP Querier Packet Version 5: Off=0 IGMP Querier disabled V1=1 6: V2=2 7: V3=3 8: Treatment of Unknown 9: Multicasts: 0=Send To All Ports 10: 1=Send To Query Ports 2=Discard
0x6	Switch Existing Ports	Get	ARRAY of: DWORD	Bitmask of existing switch ports Per bit starting with Bit 0 (=Port 1) (0=Port not available, 1=Port existing) Array (bit mask) size is adjusted to the size of maximum number of switch ports (for max. 28 Ports 1 DWORD is used)
0x7	Switch Port Control	Get/Set	ARRAY of: DWORD	Bitmask Link Admin Status switch ports Per bit starting with Bit 0 (=Port 1) (0=Port enabled, 1=Port disabled) Array (bit mask) size is adjusted to the size of maximum number of Switch ports (for max. 28 Ports 1 DWORD is used)
0x8	Switch Ports Mapping	Get	ARRAY of: USINT	Instance number of the Ethernet-Link-Object Starting with Index 0 (=Port 1) All Ethernet Link Object Instances for the existing Ethernet Switch Ports (1..N, maximum number of ports). When the entry is 0, the Ethernet Link Object for this port does not exist

Table 51: Class attributes (cont.)

Id	Attribute	Access Rule	Data type	Description
0x9	Switch Action Status	Get	DWORD	Status of the last executed action (for example config save, software update, etc.) 0: Flash Save Configuration In Progress/Flash Write In Progress 1: Flash Save Configuration Failed/Flash Write Failed 4: Configuration changed (configuration not in sync. between running configuration

The Hirschmann specific Ethernet Switch Agent Object provides you with the additional vendor specific service, with the Service Code 0x35 for saving the Switch configuration. When you send a request from your PC to save a device configuration, the device sends a reply after saving the configuration in the flash memory.

### Base Switch object

The Base Switch object provides the CIP application-level interface to basic status information for a managed Ethernet switch (revision 1).

Only Instance 1 of the Base Switch (Class Code 0x51) is available.

Table 52: Instance attributes

Id	Attribute	Access Rule	Data type	Description
0x1	Device Up Time	Get	UDINT	Time since the device powered up
0x2	Total port count	Get	UDINT	Number of physical ports
0x3	System Firmware Version	Get	SHORT-STRING	Human readable representation of System Firmware Version
0x4	Power source	Get	WORD	Status of switch power source
0x5	Port Mask Size	Get	UINT	Number of DWORD in port array attributes
0x6	Existing ports	Get	ARRAY of: DWORD	Port Mask
0x7	Global Port Admin State	Get	ARRAY of: DWORD	Port Admin Status
0x8	Global Port link Status	Get	ARRAY of: DWORD	Port Link Status
0x9	System Boot Loader Version	Get	SHORT-STRING	Readable System Firmware Version
0xA	Contact Status	Get	UDINT	Switch Contact Closure



Table 52: Instance attributes (cont.)

Id	Attribute	Access Rule	Data type	Description
0xB	Aging Time	Get	UDINT	Range 10..1000000 · 1/10 seconds (default=300) 0=Learning off
0xC	Temperature C	Get	UINT	Switch temperature in degrees Celsius
0xD	Temperature F	Get	UINT	Switch temperature in degrees Fahrenheit

**Device Level Ring object** (depends on hardware)

The Device Level Ring (DLR) object provides the configuration and status information interface for the DLR protocol (revision 2).

Only Instance 1 of the TCP/IP Interface Object (Class Code 0x47) is available.

Table 53: Class attributes

Id	Attribute	Access Rule	Data type	Description
0x1	Network Topology	Get	USINT	0: Linear 1: Ring
0x2	Network status	Get	USINT	Current status of the network. 0: normal 1: Ring Fault 2: Unexpected Loop Detection 3: Partial Network Fault 4: Rapid Fault/ Restore Cycle
0x3	Ring Supervisor Status	Get <sup>1</sup>	USINT	0: Backup 1: Active Ring Supervisor 2: Normal Ring Node 3: Non-DLR topology 4: Device cannot support the Beacon Interval or Timeout
0x4	Ring Supervisor Config	Set <sup>1</sup>	STRUCT of:	
			BOOL SupervisorEnable	Default: FALSE
			USINT SupervisorPrecedence	Default: 0
			UDINT BeaconInterval	Default: 400
			UDINT BeaconTimeout	Default: 1960
			UINT DirVlanId	Default: 0
0x5	Ring Faults Count	Set <sup>1</sup>	UINT	Number of ring faults since power up
0x6	Last Active Node on Port 1	Get <sup>1</sup>	STRUCT of:	Last Active node at the end of chain through port 1 of active ring supervisor during ring fault
			UDINT DeviceIp	
			ARRAY of:	
			6 USINT Mac	

Table 53: Class attributes (cont.)

Id	Attribute	Access Rule	Data type	Description
0x7	Last Active Node on Port 2	Get <sup>1</sup>	STRUCT of: UDINT DeviceIp ARRAY of: 6 USINT Mac	Last Active node at the end of chain through port 2 of active ring supervisor during ring fault
0x8	Ring Protocol Participants Count	Get <sup>1</sup>	UINT	Number of devices in ring protocol participants list
0x9	Ring protocol participants list	Get <sup>1</sup>	ARRAY of: STRUCT of: UDINT DeviceIp ARRAY of: 6 USINT Mac	List of devices participating in ring protocol
0xA	Active Supervisor Address	Get	STRUCT of: UDINT SupervisorIp ARRAY of: 6 USINT SupervisorMac	IP and/or MAC address of the active ring supervisor
0xB	Active Supervisor Precedence	Get <sup>1</sup>	USINT	Precedence value of the active ring supervisor
0xC	Capability Flags	Get	DWORD	Describes the DLR capabilities of the device

1. The conditional attributes are implemented for devices capable of functioning in a ring.

## Services, Connections and I/O Data

The device supports the following connection types and parameters.

Table 54: Settings for integrating a new module

Setting	I/O connection	Input only	Listen only
Comm Format:	Data - DINT	Data - DINT	Input Data - DINT - Run/Program
IP Address	IP address of the device	IP address of the device	IP address of the device
Input Assembly Instance	100	100	100
Input Size	32	32	32
Output Assembly Instance	150	152	153
Output Size	32	0	0
Configuration Assembly Instance	151	151	151
Data Size	10	10	10

Table 55: Device I/O data structure

I/O Data	Value (data types and sizes to be defined)	Direction	Size <sup>1</sup>
Device Status	Bitmask (see Switch Agent Attribute 0x1)	Input	DWORD
Link Status	Bitmask, 1 Bit per port (0=No link, 1=Link up)	Input	DWORD
Output Links Admin State applied	Bitmask (1 Bit per port) to acknowledge output. Link state change can be denied, for example for controller access port. (0=Port enabled, 1=Port disabled)	Input	DWORD
Utilization Alarm <sup>2</sup>	Bitmask, 1 Bit per port (0=No alarm, 1=Alarm on port)	Input	DWORD
Access Violation Alarm <sup>3</sup>	Bitmask, 1 Bit per port (0=No alarm, 1=Alarm on port)	Input	DWORD
Multicast Connections	Integer, number of connections	Input	DINT
TCP/IP Connections	Integer, number of connections	Input	DINT
Quick Connect Mask	Bitmask (1 Bit per port) (0=Quick Connect disabled, 1=Quick Connect enabled)	Input	DINT
Link Admin State	Bitmask, 1 Bit per port (0=Port enabled, 1=Port disabled)	Output	DWORD

1. The default size of the port bit masks is 32 bits (DWORD). For devices with more than 28 ports the port bit masks have been extended to n \* DWORD.
2. You specify the utilization alarm settings in the *Basic Settings > Port* dialog, *Utilization* tab. The upper threshold is the limit, where the alarm condition becomes active. The lower threshold is the limit, where an active alarm condition becomes inactive.
3. You specify the Access Violation alarm settings in the *Network Security > Port Security* dialog. The upper threshold is the limit, where the alarm condition becomes active. The lower threshold is the limit, where an active alarm condition becomes inactive.

Table 56: Mapping of the data types to bit sizes

Object type	Bit size
BOOL	1 bit
DINT	32 bit
DWORD	32 bit
SHORT-STRING	max. 32 bytes
STRING	max. 64 bytes
UDINT	32 bit
UINT	16 bit
USINT	8 bit
WORD	16 bit

## 16.4 PROFINET

**PROFINET** is an industrial communication network based on Ethernet that is accepted worldwide. It is based on the widely used transport protocols TCP/IP and UDP/IP (standard). This is a crucial aspect for fulfilling the requirements for consistency from the management level down to the field level.

**PROFINET** enhances the existing Profibus technology for such applications that require fast data communication and the use of industrial IT functions.

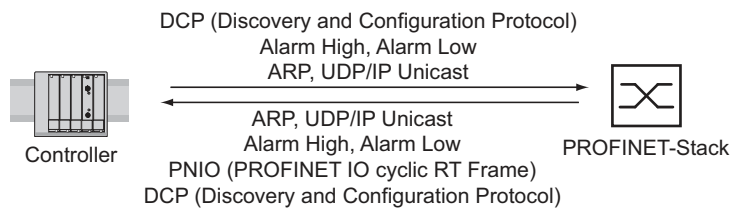

Figure 64: Communication between the Controller and the device

In particular, you will find **PROFINET** in Europe and in conjunction with Siemens controllers.

**PROFINET** uses the device description language GSDML (Generic Station Description Markup Language, based on XML - eXtended Markup Language) to describe devices and their properties so that they can be processed automatically. You will find the device description in the GSD(ML) file of the device.

You will find detailed information on **PROFINET** on the website of the PROFIBUS Organization at [www.profibus.com](http://www.profibus.com).

The devices conform to class B for **PROFINET**.

### Device Models for PROFINET GSDML Version 2.3

The device creates GSDML files in the GSDML V.2.3 format. Within the GSDML file, the device is modeled according to GSDML standard V.2.2.

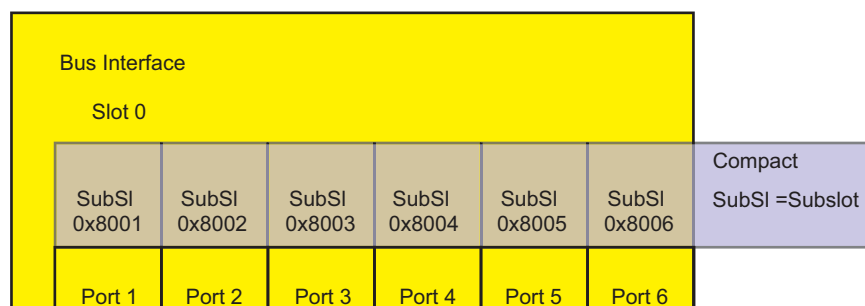

Figure 65: Compact device

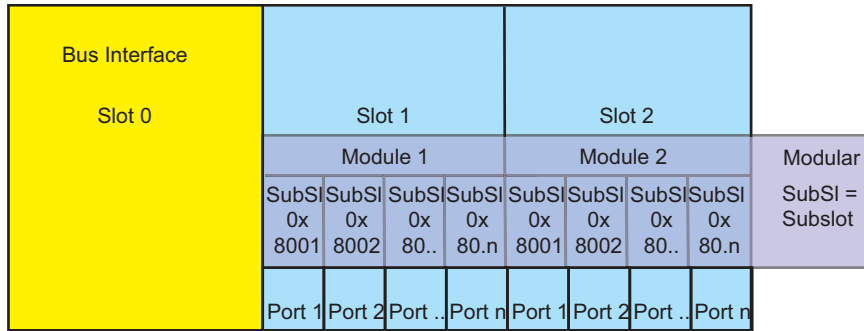

Figure 66: Modular device

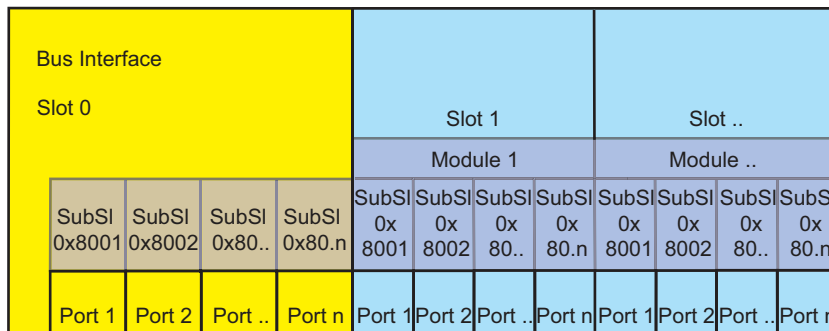

Figure 67: Mixed device

### Graphical User Interface and Command Line Interface

When the device is set up successfully in *PROFINET* environments, the automation process establishes an application relation (AR) to the device.

After the login of a user, the device displays a corresponding message via the Graphical User Interface and Command Line Interface.

If the device operates as the *Ring manager* in a MRP ring, then it does not establish the AR automatically after the device reboots. In this case, you establish the AR by disabling the MRP ring port in the device. Thus the device establishes the AR and the MRP ring closes automatically.

If the AR is already established, then keep the MRP ports enabled as long as these ports forward *PROFINET* packets.

## 16.4.1 Integration into a Control System

### Preparing the device

First you install, connect and configure the device. Then you integrate the device into a Control System. To do this, perform the following steps:

- Open the *Basic Settings > System* dialog.
- Verify that a valid system name for the device is specified in the *System name* field.
- Save the changes temporarily. To do this, click the  button.
- Open the *Basic Settings > Network* dialog.
- In the *Management interface* frame, select the *Local* radio button.
- Save the changes temporarily. To do this, click the  button.
- Open the *Switching > Global* dialog, mark the *VLAN unaware mode* checkbox.
- Save the changes temporarily. To do this, click the  button.
- Open the *Diagnostics > Status Configuration > Device Status* dialog, *Global* and *Port* tabs.
- Configure the alarm setting and the threshold value for the alarms you want to monitor.
- Save the changes temporarily. To do this, click the  button.
- Open the *Advanced > Industrial Protocols > PROFINET* dialog.
- Load the GSD(ML) file and the icon onto your local computer.  
Use the following methods to get the GSD(ML) file and the icon:
  - Download the file from the *Advanced > Industrial Protocols > PROFINET* dialog.
- To enable the function, select the *On* radio button in the *Operation* frame.
- Save the changes temporarily. To do this, click the  button.

### Default values to be changed

Functions that directly affect the *PROFINET* function require the following default values to be changed. When you obtain the device as a specially available *PROFINET* variant, the following values are already predefined:

<i>PROFINET</i>	<i>Advanced &gt; Industrial Protocols &gt; PROFINET</i> dialog <ul style="list-style-type: none"> <li>• <i>Operation=On</i></li> <li>• <i>Name of station=&lt;empty&gt;</i></li> </ul>
<i>Network</i>	<i>Basic Settings &gt; Network</i> dialog <ul style="list-style-type: none"> <li>• <i>IP address assignment=Local</i></li> <li>• <i>HiDiscovery protocol v1/v2Access=readOnly</i></li> <li>• <i>IP address=0.0.0.0</i></li> <li>• <i>Netmask=0.0.0.0</i></li> <li>• <i>Gateway address=0.0.0.0</i></li> </ul>
<i>VLAN</i>	<i>Switching &gt; Global</i> dialog <ul style="list-style-type: none"> <li>• <i>VLAN unaware mode=marked</i></li> </ul>
<i>LLDP</i>	<i>Diagnostics &gt; LLDP</i> dialog <ul style="list-style-type: none"> <li>• <i>Transmit interval [s]=5</i></li> <li>• <i>Transmit delay [s]=1</i></li> </ul>

## Configuration of the PLC

The following illustrates the configuration of the PLC using the example of the Simatic S7 software from Siemens, and assumes that you are familiar with operating the software.

The device also supports Network management stations from other manufacturers, such as PC Worx from Phoenix.

In the PLC default setting, the PLC detects the interruption of the I/O connection to the device as a failure. The PLC considers three consecutive Real Time packets missing from the PLC or from the device as an interruption. According to the default setting, this leads to a system failure. To change this default setting, you employ Step7 programming measures.

**Note:** Monitoring the I/O connection to the CPU of the device as a failure can result in a system failure. Therefore, monitoring the I/O connection as a failure criterion is less suitable.

The I/O connection between the programmable logic controller (PLC) and the device can be interrupted by a management program. For example, a management station can saturate the CPU of the device with higher priority Real Time (RT) data. In this case, the device can still transmit or receive data packets and the system remains operational.

## Providing the GDSML file

The Hirschmann device provides you with the following options for generating GDSML files and icons:

- ▶ You can use the Graphical User Interface in the [Advanced > Industrial Protocols > PROFINET](#) dialog to download the GSDML file and the icon of the device.

## Incorporating the device in the configuration

Perform the following steps:

- Open the [Simatic Manager](#) application from Simatic S7.
- Open your project.
- Go to the hardware configuration.
- Install the GSD(ML) file:
  - In the menu bar, click the items [Options > Install GSD File](#).
  - Select the GSD file previously saved on your PC.
  - Simatic S7 installs the file together with the icon.
  - You will find the new device under:
    - [PROFINET IO > Additional Field Devices > Switching Devices > Hirschmann..](#)
    - or under [PROFINET IO > Additional Field Devices > Network Components > Hirschmann..](#)
- Use the Drag-and-Drop function, pull the device onto the bus cable.

Rename the device. To do this, perform the following steps:

- Highlight the device.
- In the menu bar, click the items [PLC > Ethernet > Edit Ethernet Node](#).
- In the [Edit Ethernet Node](#) dialog, enter the name of the device in the [Assign device name](#) frame, [Device name](#) field.
- Click the [Browse...](#) button.
  - Select the device.
  - Click the [OK](#) button.
- Specify the name of the device.
  - Click the [Assign Name](#) button.
- Click the [Close](#) button.

- In the hardware configuration, right-click the device and select the *Object properties* item in the drop-down list.
- Enter the same name as specified in the *Edit Ethernet Node* dialog.
- Click the *Ethernet* button.  
Enter the IP parameters.  
To close the *Properties - Ethernet interface...* window, click the *OK* button.
- To close the *Properties* window, click the *OK* button.

The device is now included in the configuration.

### Configuring IO Cycle

Perform the following steps:

- In the hardware configuration, click the device.
- In the *Slot/Module View* dialog, right-click the X1 / PN-IO row.
- In the drop-down list, select the *Object properties* item.
- In the *Properties* window, open the *IO Cycle* tab.
- In the *Update Time* frame, *Update time[ms]:* field, select the required update time in ms, for the IO Cycle.
- In the *Watchdog Time* frame, *Number of accepted update cycles with missing IO data* field, select the required number for the IO Cycle.
- To close the *Properties* window, click the *OK* button.

### Configuring Media Redundancy

Perform the following steps:

- In the hardware configuration, left-click the device.
- In the *Slot/Module View* dialog, right-click the X1 / PN-IO row.
- In the drop-down list, select the *Object properties* item.
- In the *Properties* window, open the *Media Redundancy* tab.
- In the *MRP Configuration* frame, *Domain* field, select the required MRP domain for the node.
- In the *MRP Configuration* frame, *Role* field, select the required role of the node in the ring.
- In the *Ring Port 1* and *Ring Port 2* fields select the active MRP Ring Ports.
- To close the *Properties* window, click the *OK* button.

### Adding modules for modular devices

Perform the following step:

- Use the Drag & Drop function to pull a module from the library into a slot.  
Simatic S7 adds the ports using the Module properties.

### Configuring device property

Perform the following steps:

- In slot 0 you enter the settings for the entire device.
- Select the device.
- Right-click slot 0.  
To configure the entire device, select *Object properties*.
- In the *Properties* window, open the *Parameters* tab.



### Configuring the port properties

For modular devices, slots 1 through n represent the modules. The ports are represented as subslots/submodules.

For non-Modular devices, the subslots 1 through n in slot 0 represent the ports.

### Configuring Port Alarms

Perform the following steps:

- Right-click a port, 1 through n, and select *Object properties*.
- In the *Properties* window, open the *Parameters* tab.
- Select the desired alarms and close the window.

Special case: "LinkDown" alarm:

The LinkDown alarm is made up of the AND-link

- of the Hirschmann-specific status for connection errors and
- of the Simatic S7-specific option for the connection.

### Activating the LinkDown alarm:

Perform the following steps:

- In the *Properties* dialog, open the *Parameters* tab (Hirschmann-specific).
- To enable the *Alarms* parameter, select the value *On* in the *Value* column.
- Enable the *Link state monitoring* parameter and select the *Generate diagnosis alarm when link goes down* option in the *Value* column.
- Open the *Options* tab.
- To activate link monitoring, select a fixed setting for the port in the *Connection* frame, *Transmission medium/duplex* field.

### Configuring Connection Options

Perform the following steps:

- Right-click a port, 1 through n, and select *Object properties*.
- In the *Properties* dialog, open the *Options* tab.
- In the *Connection* frame, *Transmission medium/duplex* field, select the desired setting for the port.
- To close the *Properties* window, click the *OK* button.

If you change the port setting to a value other than *Automatic settings*, then the device disables the port for a short time. If the port is situated on the path between the I/O controller and the I/O device, then the interruption can possibly lead to a failure in establishing the Application Relation. Make the following provisions before changing the port setting:

**Note:** Beware of Loops! Deactivate RSTP in the device ports between the I/O controller and the I/O device.

- Open the *Switching > L2-Redundancy > Spanning Tree > Port* dialog, *CIST* tab.
- Unmark the *STP active* checkbox for the relevant ports.
- Save the changes temporarily. To do this, click the  button.

### Configuring Topology

Perform the following steps:

- Right-click a port, 1 through n, and select *Object properties*.
- In the *Properties* dialog, open the *Topology* tab.
- In the *Partners* frame, *Partner port* field select the required setting for the partner port.
- To close the *Properties* window, click the *OK* button.

## Swapping devices

Hirschmann devices support the device swapping function with an engineering station.

When identical devices are being swapped, the Network management station assigns the parameters of the original device to the new device.

The device swapping function with Simatic S7 requires the following prerequisites:

- ▶ S7 300 with SW release from V2.7 (currently available for CPU 319) or S7 400 with SW release from V5.2
- ▶ Hirschmann device SW release from 05.0.00
- ▶ Neighboring device(s) support(s) LLDP
- ▶ Topology (=neighborhood relationships) is configured and loaded onto SPS

Device swapping requires the following conditions:

- ▶ the replacement device is exactly the same type as the device to be replaced.
- ▶ the replacement device is connected to the exact same place in the network (same ports and neighboring devices).
- ▶ the replacement device has a *PROFINET* default configuration. Set the device name to "" (null string).

When these conditions are met, the Network management station automatically assigns the parameters of the original device (device name, IP parameters and configuration data) to the replacement device.

### Procedure for swapping devices:

Perform the following steps:

- System name "" (= null string)
  - IP address = 0.0.0.0 or DHCP
  - *PROFINET* activated
- Make a note of the port assignment on the original device and remove the original device from the system.
  - The PLC now detects an error.
- Now insert the replacement device in the same position in the network. Verify that the port assignments are the same as the original device.

The PLC finds the replacement device and configures it like the original device.

The PLC detects proper operation.

When necessary, reset the PLC to "Run".

## Swapping modules

The *PROFINET* stack in the device detects a change in the connected modules and reports the change to the engineering station. When a previously configured module is removed from the device, the engineering station reports an error. When a configured module that was missing is connected, the Network management station removes the error message.

### **Topology Discovery**

After you initialize the Topology Discovery, the Network management station looks for connected devices.

### **Configuring the topology**

Simatic S7 gives you the option to configure the topology and monitor it accordingly.

Simatic S7 displays the connection parameters (quality and settings) in a colored graphic.

### **Communication diagnosis**

Simatic S7 monitors the communication quality and outputs messages relating to communication problems.

### **Outputting port statistics**

Simatic S7 counts for each port the number of data packets received and sent, the collisions, etc. You can view these figures in the form of statistic tables in Simatic S7.

## **16.4.2 PROFINET Parameter**

### **Alarms**

The device supports alarms in the device and port levels.

*Table 57: Alarms supported*

Alarms on device level	Change in device status Failure of redundant power supply Failure/removal of ACA
Alarms on port level	Change in link status Specified transfer rate exceeded.

## Record parameters

The device provides records for:

- ▶ Device parameters
- ▶ Device status
- ▶ Port status/parameters

Table 58: Device parameters

Byte	Content	Access	Value	Meaning
0	Send alarm if status changes	rw	0	Do not send alarm
			1	Send alarm if one of the following alarm reasons occurs.
1	Power Alarm	rw	0	Do not send alarm
			1	Send alarm if a power supply fails.
2	ACA Alarm	rw	0	Do not send alarm
			1	Send alarm if the ACA is removed.
3	Module Alarm	rw	0	Do not send alarm
			1	Send alarm if the module connections are changed.

Table 59: Device status

Byte	Content	Access	Value	Meaning
0	Device status	ro	0	Unavailable
			1	OK
			2	Error
1	Power supply unit 1	ro	0	Unavailable
			1	OK
			2	Error
2	Power supply unit 2	ro	0	Unavailable
			1	OK
			2	Error
3	Power supply unit 3	ro	0	Unavailable
			1	OK
			2	Error
4	Power supply unit 4	ro	0	Unavailable
			1	OK
			2	Error
5	Power supply unit 5	ro	0	Unavailable
			1	OK
			2	Error
6	Power supply unit 6	ro	0	Unavailable
			1	OK
			2	Error
7	Power supply unit 7	ro	0	Unavailable
			1	OK
			2	Error
8	Power supply unit 8	ro	0	Unavailable
			1	OK
			2	Error
9	Signal contact 1	ro	0	Unavailable
			1	Closed
			2	Open

Table 59: Device status

Byte	Content	Access	Value	Meaning
10	Signal contact 2	ro	0	Unavailable
			1	Closed
			2	Open
11	Temperature	ro	0	Unavailable
			1	OK
			2	Threshold value for temperature exceeded or not reached
12	Fan	ro	0	Unavailable
			1	OK
			2	Fan failure
13	Module removal	ro	0	Unavailable
			1	OK
			2	A module has been removed.
14	ACA Removed	ro	0	Unavailable
			1	OK
			2	The ACA has been removed.
15	Not used		0	
			1	
			2	
16	Not used		0	
			1	
			2	
17	Connection	ro	0	Unavailable
			1	OK
			2	Connection failure.

Table 60: Port status/parameters

Byte	Content	Access	Value	Meaning
0	Report port error	rw	0	Do not send alarm
			1	When one of the following alarm reasons occurs, send an alarm.
1	Report connection error	rw	0	Do not send alarm
			1	Send alarm if the connection has failed.
2	Transmission rate too high	rw	0	Do not send alarm
			1	Send alarm if the threshold value for the temperature has been exceeded.
3	Port on	rw	0	Unavailable
			1	Switched on
			2	Switched off
4	Link status	ro	0	Unavailable
			1	Connection exists
			2	Connection interrupted

Table 60: Port status/parameters

Byte	Content	Access	Value	Meaning
5	Bit rate	ro	0	Unavailable
			1	Unknown
			2	10 MBit/s
			2	100 MBit/s
			2	1000 MBit/s
6	Duplex	ro	0	Half duplex
			1	Full duplex
			2	Full duplex
7	Autonegotiation	ro	0	Unavailable
			1	off
			2	on

## I/O Data

You will find the bit assignment for the transferred I/O data in the following table.

Table 61: Device I/O data

Direction	Byte	Bit	Meaning
Input	0		General
		0	Device status
		1	Signal contact 1
		2	Signal contact 2
		3	Temperature
		4	Fan
		5	Module removal
		6	ACA Removed
Input	1		Power supply status
		0	Power supply unit 1
		1	Power supply unit 2
		2	Power supply unit 3
		3	Power supply unit 4
		4	Power supply unit 5
		5	Power supply unit 6
		6	Power supply unit 7
Input	2		Supply voltage status
		0	Not used
		1	Not used
		2	Connection error
		3	Not used
		4	Not used
		5	Not used
		6	Not used
7	Not used		
Output			Not defined
Meaning of the bit content:			
0: OK or unavailable			
1: Reason for report exists			

Table 62: Port I/O data

Direction	Byte	Bit	Meaning
Input	0		Connection status for ports 1 to 8
		0	Port 1
		1	Port 2
		2	Port 3
		3	Port 4
		4	Port 5
		5	Port 6
		6	Port 7
Input	1		Connection status for ports 9 to 16
		0	Port 9
		1	Port 10
		2	Port 11
		3	Port 12
		4	Port 13
		5	Port 14
		6	Port 15
Input	n		Connection for port $(n * 8) + 1$ to port $(n * 8) + 8$
		0	Port $(n * 8) + 1$
		1	Port $(n * 8) + 2$
		2	Port $(n * 8) + 3$
		3	Port $(n * 8) + 4$
		4	Port $(n * 8) + 5$
		5	Port $(n * 8) + 6$
		6	Port $(n * 8) + 7$
7	Port $(n * 8) + 8$		
Means the Input Bit contains:			
<ul style="list-style-type: none"> <li>• 0: no connection</li> <li>• 1: active connection</li> </ul>			
Output	0		"Port activated" for ports 1 to 8
		0	Port 1 activated
		1	Port 2 activated
		2	Port 3 activated
		3	Port 4 activated
		4	Port 5 activated
		5	Port 6 activated
		6	Port 7 activated
7	Port 8 activated		

Table 62: Port I/O data

Direction	Byte	Bit	Meaning
Output	1		"Port activated" for ports 9 to 16
		0	Port 9 activated
		1	Port 10 activated
		2	Port 11 activated
		3	Port 12 activated
		4	Port 13 activated
		5	Port 14 activated
		6	Port 15 activated
	7	Port 16 activated	
Output	n		"Port activated" for port $(n * 8) + 1$ to port $(n * 8) + 8$
		0	Port $(n * 8) + 1$ activated
		1	Port $(n * 8) + 2$ activated
		2	Port $(n * 8) + 3$ activated
		3	Port $(n * 8) + 4$ activated
		4	Port $(n * 8) + 5$ activated
		5	Port $(n * 8) + 6$ activated
		6	Port $(n * 8) + 7$ activated
	7	Port $(n * 8) + 8$ activated	

Means the Output Bit contains:

- 0: no port active
- 1: active active





## A Setting up the configuration environment

### A.1 Setting up a DHCP/BOOTP server

The following example describes the configuration of a DHCP server using the haneWIN DHCP Server software. This shareware software is a product of IT-Consulting Dr. Herbert Hanewinkel. You can download the software from <https://www.hanewin.net>. You can test the software for 30 calendar days from the date of the first installation, and then decide if you want to purchase a license.

Perform the following steps:

- To install the DHCP servers on your PC put the product CD in the CD drive of your PC and under Additional Software select *haneWIN DHCP Server*. To carry out the installation, follow the installation assistant.
- Start the *haneWIN DHCP Server* program.



Figure 68: Start window of the *haneWIN DHCP Server* program

**Note:** When Windows is activated, the installation procedure includes a service that is automatically started in the basic configuration. This service is also active although the program itself has not been started. When started, the service responds to DHCP queries.

- In the menu bar, click the items *Options > Preferences* to open the program settings window.
- Select the *DHCP* tab.
- Specify the settings displayed in the figure.

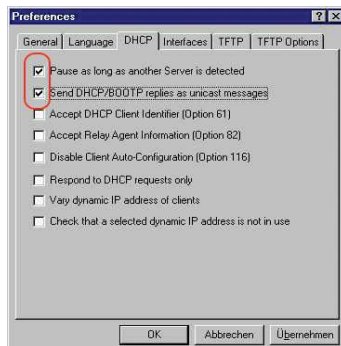

Figure 69: DHCP setting

- Click the *OK* button.
- To enter the configuration profiles, click in the menu bar the items *Options > Configuration Profiles*.

## Setting up the configuration environment

### A.1 Setting up a DHCP/BOOTP server

- Specify the name for the new configuration profile.

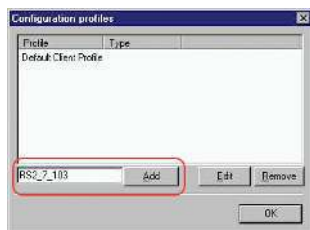

Figure 70: Adding configuration profiles

- Click the *Add* button.
- Specify the netmask.

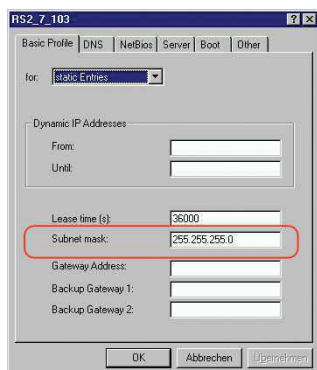

Figure 71: Netmask in the configuration profile

- Click the *Apply* button.
- Select the *Boot* tab.
- Enter the IP address of your tftp server.
- Enter the path and the file name for the configuration file.

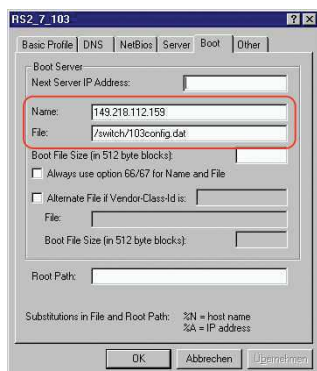

Figure 72: Configuration file on the tftp server

- Click the *Apply* button and then the *OK* button.

- Add a profile for each device type.  
When devices of the same type have different configurations, you add a profile for each configuration.

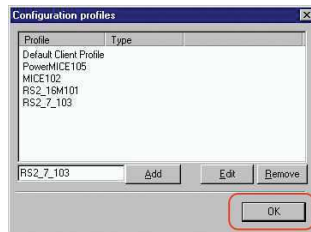

Figure 73: Managing configuration profiles

- To complete the addition of the configuration profiles, click the **OK** button.
- To enter the static addresses, in the main window, click the **Static** button.

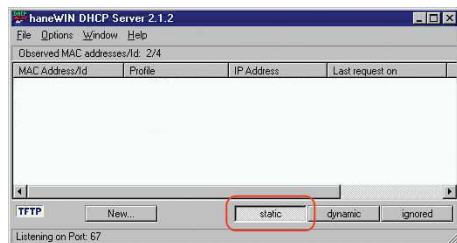

Figure 74: Static address input

- Click the **Add** button.

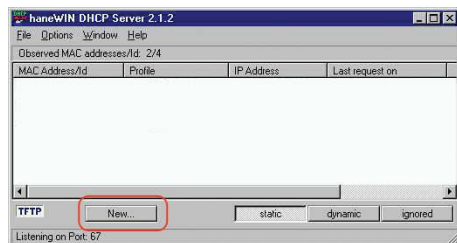

Figure 75: Adding static addresses

- Enter the MAC address of the device.
- Enter the IP address of the device.

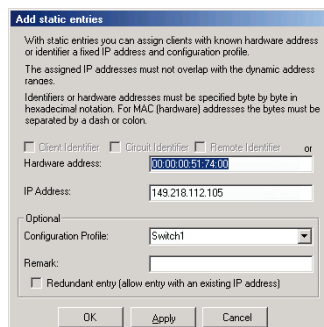

Figure 76: Entries for static addresses

- Select the configuration profile of the device.

## Setting up the configuration environment

### A.1 Setting up a DHCP/BOOTP server

---

- Click the *Apply* button and then the *OK* button.
- Add an entry for each device that will get its parameters from the DHCP server.

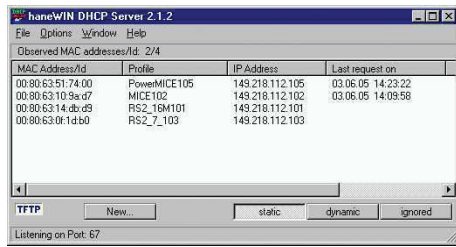

Figure 77: DHCP server with entries

## A.2 Setting up a DHCP server with Option 82

The following example describes the configuration of a DHCP server using the haneWIN DHCP Server software. This shareware software is a product of IT-Consulting Dr. Herbert Hanewinkel. You can download the software from <https://www.hanewin.net>. You can test the software for 30 calendar days from the date of the first installation, and then decide if you want to purchase a license.

Perform the following steps:

- To install the DHCP servers on your PC put the product CD in the CD drive of your PC and under Additional Software select *haneWIN DHCP Server*. To carry out the installation, follow the installation assistant.
- Start the *haneWIN DHCP Server* program.

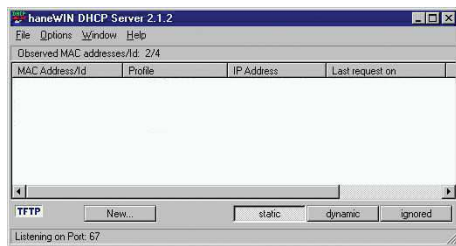

Figure 78: Start window of the *haneWIN DHCP Server* program

**Note:** When Windows is activated, the installation procedure includes a service that is automatically started in the basic configuration. This service is also active although the program itself has not been started. When started, the service responds to DHCP queries.

## Setting up the configuration environment

### A.2 Setting up a DHCP server with Option 82

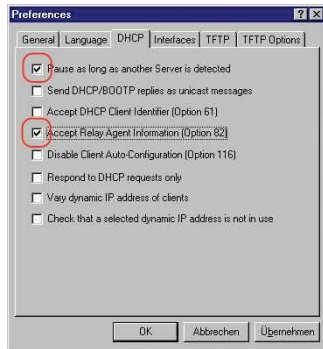

Figure 79: DHCP setting

- To enter the static addresses, click the *Add* button.

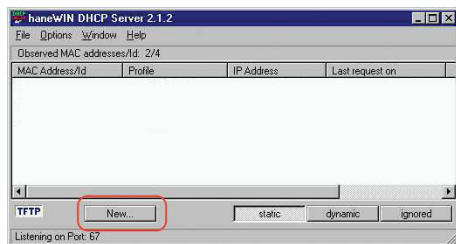

Figure 80: Adding static addresses

- Mark the *Circuit Identifier* checkbox.
- Mark the *Remote Identifier* checkbox.

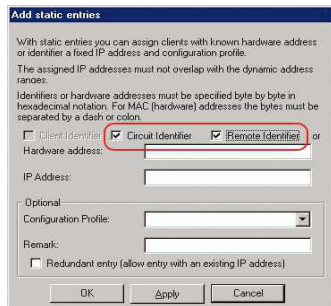

Figure 81: Default setting for the fixed address assignment

- In the *Hardware address* field, specify the value *Circuit Identifier* and the value *Remote Identifier* for the switch and port.

The DHCP server assigns the IP address specified in the *IP address* field to the device that you connect to the port specified in the *Hardware address* field.

The hardware address is in the following form:

`cic1hhvvvvssmmpprirlxxxxxxxxxxxx`

- ▶ `ci`  
Sub-identifier for the type of the Circuit ID

- ▶ `cl`  
Length of the Circuit ID.

- ▶ `hh`  
Hirschmann identifier:  
`01` when a Hirschmann device is connected to the port, otherwise `00`.

- ▶ `vvvv`  
VLAN ID of the DHCP request.  
Default setting: `0001` = VLAN 1

- ▶ **ss**  
Socket of device at which the module with that port is located to which the device is connected. Specify the value 00.
- ▶ **mm**  
Module with the port to which the device is connected.
- ▶ **pp**  
Port to which the device is connected.
- ▶ **ri**  
Sub-identifier for the type of the Remote ID
- ▶ **rl**  
Length of the Remote ID.
- ▶ **xxxxxxxxxxxx**  
Remote ID of the device (for example MAC address) to which a device is connected.

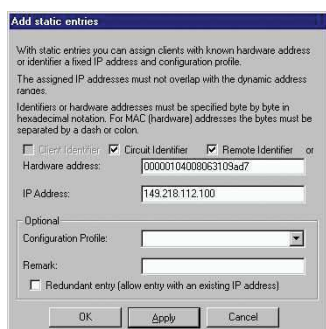

Figure 82: Specifying the addresses

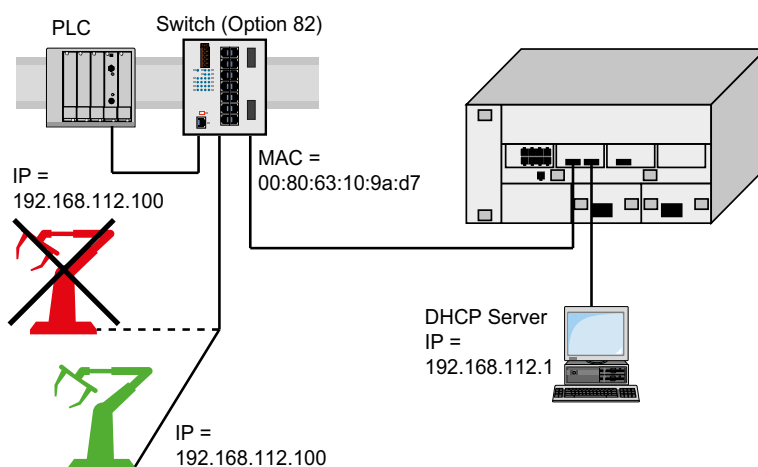

Figure 83: Application example of using Option 82



## A.3 Preparing access via SSH

You can connect to the device using SSH. To do this, perform the following steps:

- ▶ Generate a key in the device.  
or
- ▶ Transfer your own key onto the device.
- ▶ Prepare access to the device in the SSH client program.

**Note:** In the default setting, the key is already existing and access using SSH is enabled.

### A.3.1 Generating a key in the device

The device lets you generate the key directly in the device. To do this, perform the following steps:

- Open the *Device Security > Management Access > Server* dialog, *SSH* tab.
- To disable the SSH server, select the *Off* radio button in the *Operation* frame.
- Save the changes temporarily. To do this, click the  button.
- To create a RSA key, in the *Signature* frame, click the *Create* button.
- To enable the SSH server, select the *On* radio button in the *Operation* frame.
- Save the changes temporarily. To do this, click the  button.

enable

configure

ssh key rsa generate

Change to the Privileged EXEC mode.

Change to the Configuration mode.

Generate a new RSA key.

### A.3.2 Loading your own key onto the device

OpenSSH gives experienced network administrators the option of generating an own key. To generate the key, enter the following commands on your PC:

```
ssh-keygen(.exe) -q -t rsa -f rsa.key -C '' -N ''  
rsaparam -out rsaparam.pem 2048
```

The device lets you transfer your own SSH key onto the device. To do this, perform the following steps:

- Open the *Device Security > Management Access > Server* dialog, *SSH* tab.
- To disable the SSH server, select the *Off* radio button in the *Operation* frame.
- Save the changes temporarily. To do this, click the  button.
- When the host key is located on your PC or on a network drive, drag and drop the file that contains the key in the  area. Alternatively click in the area to select the file.

- Click the *Start* button in the *Key import* frame to load the key onto the device.
- To enable the SSH server, select the *On* radio button in the *Operation* frame.
- Save the changes temporarily. To do this, click the  button.

Perform the following steps:

- Copy the self-generated key from your PC to the external memory.
- Copy the key from the external memory into the device.

```
enable
```

```
copy sshkey envm <file name>
```

Change to the Privileged EXEC mode.

Load your own key onto the device from the external memory.

### A.3.3 Preparing the SSH client program

The *PuTTY* program lets you access the device using SSH. This program is provided on the product CD.

Perform the following steps:

- Start the program by double-clicking on it.

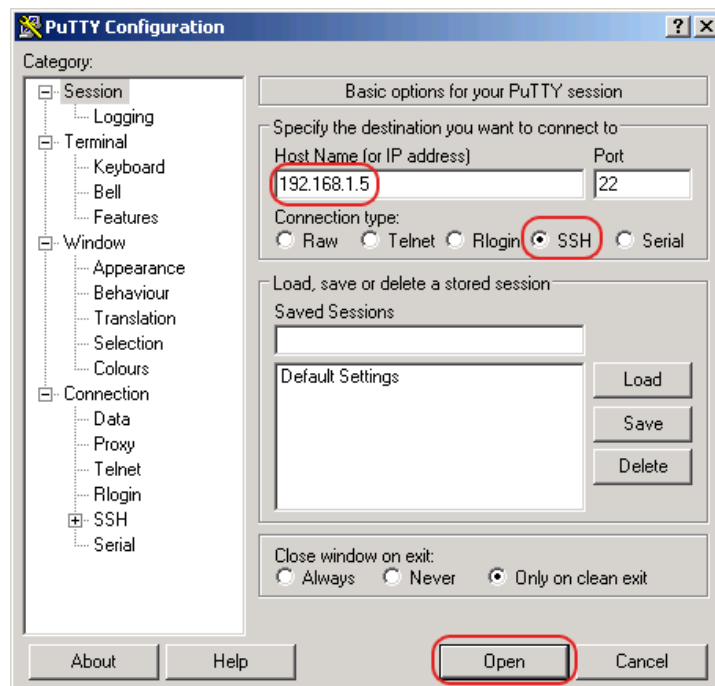

Figure 84: PuTTY input screen

- In the *Host Name (or IP address)* field you enter the IP address of your device. The IP address (a.b.c.d) consists of 4 decimal numbers with values from 0 to 255. The 4 decimal numbers are separated by points.
- To select the connection type, select the *SSH* radio button in the *Connection type* option list.
- Click the *Open* button to set up the data connection to your device.

Before the connection is established, the *PuTTY* program displays a security alarm message and lets you check the key fingerprint.



Figure 85: Security alert prompt for the fingerprint

Before the connection is established, the *PuTTY* program displays a security alarm message and lets you check the key fingerprint.

- Check the fingerprint of the key to help ensure that you have actually connected to the desired device.
- When the fingerprint matches your key, click the *Yes* button.

For experienced network administrators, another way of accessing your device through an SSH is by using the OpenSSH Suite. To set up the data connection, enter the following command:

```
ssh admin@10.0.112.53
```

*admin* is the user name.

*10.0.112.53* is the IP address of your device.

## A.4 HTTPS certificate

Your web browser establishes the connection to the device using the HTTPS protocol. The prerequisite is that you enable the *HTTPS server* function in the *Device Security > Management Access > Server* dialog, *HTTPS* tab.

**Note:** Third-party software such as web browsers validate certificates based on criteria such as their expiration date and current cryptographic parameter recommendations. Old certificates can cause errors for example, an expired certificate or cryptographic recommendations change. To solve validation conflicts with third-party software, transfer your own up-to-date certificate onto the device or regenerate the certificate with the latest firmware.

### A.4.1 HTTPS certificate management

A standard certificate according to X.509/PEM (Public Key Infrastructure) is required for encryption. In the default setting, a self-generated certificate is already present in the device. To do this, perform the following steps:

- Open the *Device Security > Management Access > Server* dialog, *HTTPS* tab.
- To create a X509/PEM certificate, in the *Certificate* frame, click the *Create* button.
- Save the changes temporarily. To do this, click the  button.
- Restart the HTTPS server to activate the key. Restart the server using the Command Line Interface.

<code>enable</code>	Change to the Privileged EXEC mode.
<code>configure</code>	Change to the Configuration mode.
<code>https certificate generate</code>	Generate a https X.509/PEM Certificate.
<code>no https server</code>	Disable the <i>HTTPS</i> function.
<code>https server</code>	Enable the <i>HTTPS</i> function.

- The device also enables you to transfer an externally generated X.509/PEM certificate onto the device:

- Open the *Device Security > Management Access > Server* dialog, *HTTPS* tab.
- When the certificate is located on your PC or on a network drive, drag and drop the certificate in the  area. Alternatively click in the area to select the certificate.
- Click on the *Start* button to copy the certificate to the device.
- Save the changes temporarily. To do this, click the  button.

<code>enable</code>	Change to the Privileged EXEC mode.
<code>copy httpscert envm &lt;file name&gt;</code>	Copy HTTPS certificate from external non-volatile memory device.

```
configure
no https server
https server
```

Change to the Configuration mode.  
Disable the *HTTPS* function.  
Enable the *HTTPS* function.

**Note:** To activate the certificate after you created or transferred it, reboot the device or restart the HTTPS server. Restart the HTTPS server using the Command Line Interface.

#### A.4.2 Access through HTTPS

The default setting for HTTPS data connection is TCP port 443. If you change the number of the HTTPS port, then reboot the device or the HTTPS server. Thus the change becomes effective. To do this, perform the following steps:

- Open the *Device Security > Management Access > Server* dialog, *HTTPS* tab.
- To enable the function, select the *On* radio button in the *Operation* frame.
- To access the device by HTTPS, enter HTTPS instead of HTTP in your browser, followed by the IP address of the device.

```
enable
configure
https port 443

https server

show https
```

Change to the Privileged EXEC mode.  
Change to the Configuration mode.  
Specifies the number of the TCP port on which the web server receives HTTPS requests from clients.  
Enable the *HTTPS* function.  
Displays the status of the *HTTPS* server and the port number.

When you make changes to the HTTPS port number, disable the HTTPS server and enable it again in order to make the changes effective.

The device uses HTTPS protocol and establishes a new data connection. When you log out at the end of the session, the device terminates the data connection.

## B Appendix

### B.1 Literature references

A small selection of books on network topics, ordered by publication date (newest first):

- ▶ TSN – Time-Sensitive Networking (in German)  
Wolfgang Schulte  
VDE Verlag, 2020  
ISBN 978-3-8007-5078-8
- ▶ Time-Sensitive Networking For Dummies, Belden/Hirschmann Special Edition (in English)  
Oliver Kleineberg and Axel Schneider  
Wiley, 2018  
ISBN 978-1-119-52791-6 (Print), ISBN 978-1-119-52799-2 (eBook)  
Get your free PDF copy on <https://www.belden.com/resources/knowledge/ebooks/time-sensitive-networking-for-dummies-lp>
- ▶ IPv6: Grundlagen - Funktionalität - Integration (in German)  
Silvia Hagen  
Sunny Connection, 3rd edition, 2016  
ISBN 978-3-9522942-3-9 (Print), ISBN 978-3-9522942-8-4 (eBook)
- ▶ IPv6 Essentials (in English)  
Silvia Hagen  
O'Reilly, 3rd edition, 2014  
ISBN 978-1-449-31921-2 (Print)
- ▶ TCP/IP Illustrated, Volume 1: The Protocols (2nd Edition) (in English)  
W. R. Stevens and Kevin R. Fall  
Addison Wesley, 2011  
ISBN 978-0-321-33631-6
- ▶ Measurement, Control and Communication Using IEEE 1588 (in English)  
John C. Eidson  
Springer, 2006  
ISBN 978-1-84628-250-8 (Print), ISBN 978-1-84628-251-5 (eBook)
- ▶ TCP/IP: Der Klassiker. Protokollanalyse. Aufgaben und Lösungen (in German)  
W. R. Stevens  
Hüthig-Verlag, 2008  
ISBN 978-3-7785-4036-7
- ▶ Optische Übertragungstechnik in der Praxis (in German)  
Christoph Wrobel  
Hüthig-Verlag, 3rd edition, 2004  
ISBN 978-3-8266-5040-6

## **B.2 Maintenance**

Hirschmann is continually working on improving and developing their software. Check regularly if there is an updated version of the software that provides you with additional benefits. You find information and software downloads on the Hirschmann product pages on the Internet at [www.hirschmann.com](http://www.hirschmann.com).

## B.3 Management Information Base (MIB)

The Management Information Base (MIB) is designed in the form of an abstract tree structure.

The branching points are the object classes. The "leaves" of the MIB are called generic object classes.

When this is required for unique identification, the generic object classes are instantiated, that means the abstract structure is mapped onto reality, by specifying the port or the source address.

Values (integers, time ticks, counters or octet strings) are assigned to these instances; these values can be read and, in some cases, modified. The object description or object ID (OID) identifies the object class. The subidentifier (SID) is used to instantiate them.

Example:

The generic object class `hm2PSSState` (OID = `1.3.6.1.4.1.248.11.11.1.1.1.1.2`) is the description of the abstract information `power supply status`. However, it is not possible to read any value from this, as the system does not know which power supply is meant.

Specifying the subidentifier `2` maps this abstract information onto reality (instantiates it), thus identifying it as the operating status of power supply `2`. A value is assigned to this instance and can be read. The instance `get 1.3.6.1.4.1.248.11.11.1.1.1.1.2.1` returns the response `1`, which means that the power supply is ready for operation.

Definition of the syntax terms used:	
Integer	An integer in the range $-2^{31} - 2^{31}-1$
IP address	<code>xxx.xxx.xxx.xxx</code> ( <code>xxx</code> = integer in the range <code>0..255</code> )
MAC address	12-digit hexadecimal number in accordance with ISO/IEC 8802-3
Object Identifier	<code>x.x.x.x...</code> (for example <code>1.3.6.1.1.4.1.248...</code> )
Octet String	ASCII character string
PSID	Power supply identifier (number of the power supply unit)
TimeTicks	Stopwatch, Elapsed time = numerical value / 100 (in seconds) numerical value = integer in the range $0-2^{32}-1$
Timeout	Time value in hundredths of a second time value = integer in the range $0-2^{32}-1$
Type field	4-digit hexadecimal number in accordance with ISO/IEC 8802-3
Counter	Integer ( $0-2^{32}-1$ ), when certain events occur, the value increases by <code>1</code> .



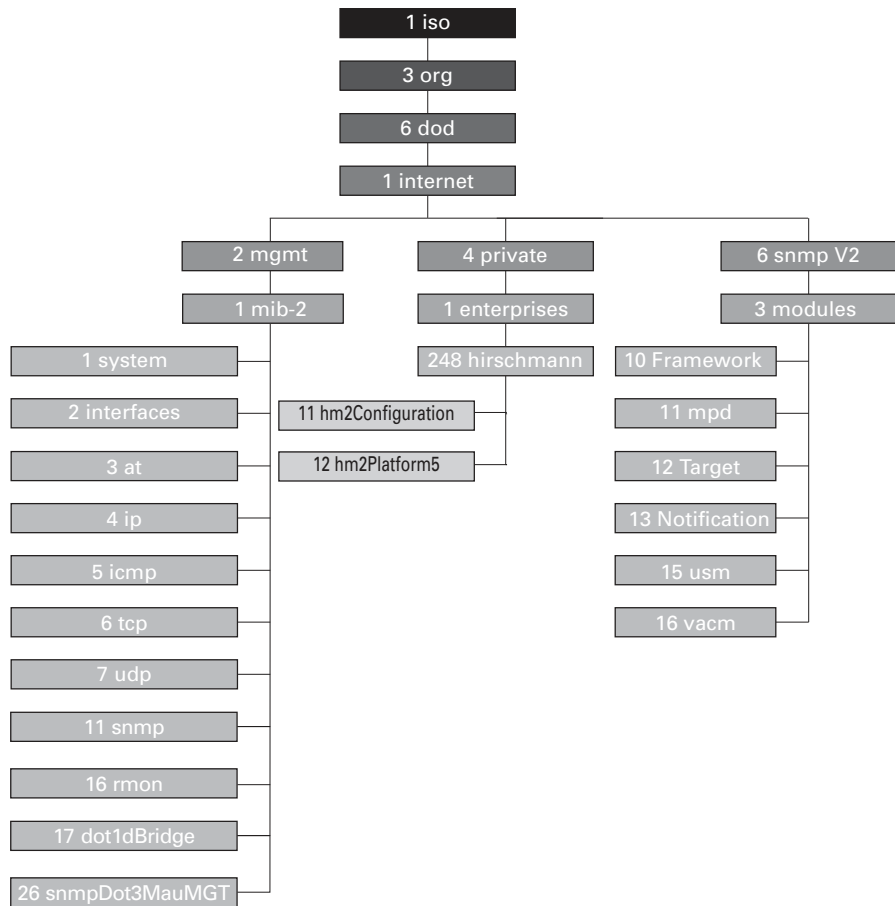

Figure 86: Tree structure of the Hirschmann MIB

A description of the MIB can be found on the product CD provided with the device.

## B.4 List of RFCs

RFC 768	UDP
RFC 783	TFTP
RFC 791	IP
RFC 792	ICMP
RFC 793	TCP
RFC 826	ARP
RFC 854	Telnet
RFC 855	Telnet Option
RFC 951	BOOTP
RFC 1112	IGMPv1
RFC 1157	SNMPv1
RFC 1155	SMIv1
RFC 1212	Concise MIB Definitions
RFC 1213	MIB2
RFC 1493	Dot1d
RFC 1542	BOOTP-Extensions
RFC 1643	Ethernet-like -MIB
RFC 1757	RMON
RFC 1867	Form-Based File Upload in HTML
RFC 1901	Community based SNMP v2
RFC 1905	Protocol Operations for SNMP v2
RFC 1906	Transport Mappings for SNMP v2
RFC 1945	HTTP/1.0
RFC 2068	HTTP/1.1 protocol as updated by draft-ietf-http-v11-spec-rev-03
RFC 2131	DHCP
RFC 2132	DHCP-Options
RFC 2233	The Interfaces Group MIB using SMI v2
RFC 2236	IGMPv2
RFC 2246	The TLS Protocol, Version 1.0
RFC 2346	AES Ciphersuites for Transport Layer Security
RFC 2365	Administratively Scoped IP Multicast
RFC 2578	SMIv2
RFC 2579	Textual Conventions for SMI v2
RFC 2580	Conformance statements for SMI v2
RFC 2613	SMON
RFC 2618	RADIUS Authentication Client MIB
RFC 2620	RADIUS Accounting MIB
RFC 2674	Dot1p/Q
RFC 2818	HTTP over TLS
RFC 2851	Internet Addresses MIB
RFC 2863	The Interfaces Group MIB
RFC 2865	RADIUS Client
RFC 2866	RADIUS Accounting

RFC 2868	RADIUS Attributes for Tunnel Protocol Support
RFC 2869	RADIUS Extensions
RFC 2869bis	RADIUS support for EAP
RFC 2933	IGMP MIB
RFC 3164	The BSD Syslog Protocol
RFC 3376	IGMPv3
RFC 3410	Introduction and Applicability Statements for Internet Standard Management Framework
RFC 3411	An Architecture for Describing Simple Network Management Protocol (SNMP) Management Frameworks
RFC 3412	Message Processing and Dispatching for the Simple Network Management Protocol (SNMP)
RFC 3413	Simple Network Management Protocol (SNMP) Applications
RFC 3414	User-based Security Model (USM) for version 3 of the Simple Network Management Protocol (SNMPv3)
RFC 3415	View-based Access Control Model (VACM) for the Simple Network Management Protocol (SNMP)
RFC 3418	Management Information Base (MIB) for the Simple Network Management Protocol (SNMP)
RFC 3580	802.1X RADIUS Usage Guidelines
RFC 3584	Coexistence between Version 1, Version 2, and Version 3 of the Internet-standard Network Management Framework
RFC 3621	Power Ethernet MIB
RFC 4022	Management Information Base for the Transmission Control Protocol (TCP)
RFC 4113	Management Information Base for the User Datagram Protocol (UDP)
RFC 4188	Definitions of Managed Objects for Bridges
RFC 4251	SSH protocol architecture
RFC 4252	SSH authentication protocol
RFC 4253	SSH transport layer protocol
RFC 4254	SSH connection protocol
RFC 4293	Management Information Base for the Internet Protocol (IP)
RFC 4318	Definitions of Managed Objects for Bridges with Rapid Spanning Tree Protocol
RFC 4330	Simple Network Time Protocol (SNTP) Version 4 for IPv4, IPv6 and OSI
RFC 4363	Definitions of Managed Objects for Bridges with Traffic Classes, Multicast Filtering, and Virtual LAN Extensions
RFC 4541	Considerations for Internet Group Management Protocol (IGMP) and Multicast Listener Discovery (MLD) Snooping Switches
RFC 4836	Definitions of Managed Objects for IEEE 802.3 Medium Attachment Units (MAUs)

## **B.5 Underlying IEEE Standards**

IEEE 802.1AB	Station and Media Access Control Connectivity Discovery
IEEE 802.1D	MAC Bridges (switching function)
IEEE 802.1Q	Virtual LANs (VLANs, MRP, Spanning Tree)
IEEE 802.1X	Port Authentication
IEEE 802.3	Ethernet
IEEE 802.3ac	VLAN Tagging
IEEE 802.3x	Flow Control
IEEE 802.3af	Power over Ethernet

## **B.6 Underlying IEC Norms**

---

IEC 62439	High availability automation networks HSR – High-availability Seamless Redundancy MRP – Media Redundancy Protocol based on a ring topology PRP – Parallel Redundancy Protocol
-----------	--

---

## **B.7 Underlying ANSI Norms**

---

ANSI/TIA-1057 Link Layer Discovery Protocol for Media Endpoint Devices, April 2006

---

## B.8 Technical Data

Switching	
Size of the MAC address table (incl. static filters)	16384
Max. number of statically configured MAC address filters	100
Max. number of MAC address filters learnable through IGMP Snooping	1024
Max. number of MAC address entries (MMRP)	64
Number of priority queues	8 Queues
Port priorities that can be set	0..7
MTU (Max. allowed length of packets a port can receive or transmit)	12288 Bytes

VLAN	
VLAN ID range	1..4042
Number of VLANs	max. 256 simultaneously per device max. 256 simultaneously per port

Access Control Lists (ACL)	
Max. number of ACLs	50
Max. number of rules per ACL	256
Max. number of rules per port	256
Number of total configurable rules	2048 (8x256)
Max. number of VLAN assignments	12
Max. number of rules which log an event	128
Max. number of Ingress rules	768

## **B.9 Copyright of integrated Software**

The product contains, among other things, Open Source Software files developed by third parties and licensed under an Open Source Software license.

You can find the license terms in the Graphical User Interface in the [Help > Licenses](#) dialog.



## **B.10 Abbreviations used**

ACA	Name of the external memory
ACL	Access Control List
BOOTP	Bootstrap Protocol
CLI	Command Line Interface
DHCP	Dynamic Host Configuration Protocol
EUI	Extended Unique Identifier
FDB	Forwarding Database
GUI	Graphical User Interface
HTTP	Hypertext Transfer Protocol
HTTPS	Hypertext Transfer Protocol Secure
ICMP	Internet Control Message Protocol
IEEE	Institute of Electrical and Electronics Engineers
IGMP	Internet Group Management Protocol
IP	Internet Protocol
LED	Light Emitting Diode
LLDP	Link Layer Discovery Protocol
MAC	Media Access Control
MIB	Management Information Base
MRP	Media Redundancy Protocol
NMS	Network Management System
PC	Personal Computer
PTP	Precision Time Protocol
QoS	Quality of Service
RFC	Request For Comment
RM	Redundancy Manager
RSTP	Rapid Spanning Tree Protocol
SCP	Secure Copy
SFP	Small Form-factor Pluggable
SFTP	SSH File Transfer Protocol
SNMP	Simple Network Management Protocol
SNTP	Simple Network Time Protocol
TCP	Transmission Control Protocol
TFTP	Trivial File Transfer Protocol
TP	Twisted Pair
UDP	User Datagram Protocol
URL	Uniform Resource Locator
UTC	Coordinated Universal Time
VLAN	Virtual Local Area Network

## C Index

<b>0-9</b>	
802.1X	57
<b>A</b>	
Access roles	61
Access security	89
Advanced Mode	171, 173
Aging time	122
Alarm	223, 304
Alarm messages	221
Alarm setting	299
Alternate port	207, 213
APNIC	42
ARIN	42
ARP	44
Authentication list	57
Automatic configuration	90
<b>B</b>	
Backup port	208, 213
Bandwidth	139
Best Master Clock algorithm	117
BOOTP	41
Boundary clock (PTP)	116
BPDU	201
BPDU guard	212, 213
Bridge Identifier	199
Bridge Protocol Data Unit	201
<b>C</b>	
CD-ROM	311, 315
CIDR	44
CIP	278
Classless inter domain routing	44
Closed circuit	232
Command Line Interface	16
Command tree	27
Common Industrial Protocol	278
Compatibility (STP)	209
Configuration file	51
Configuration modifications	221
Conformity class	297

<b>D</b>	
DAN (depends on hardware)	179
Data traffic	101
Daylight saving time	111
Delay (PTP)	117
Delay measurement (PTP)	117
Delay time (MRP)	171
Denial of Service	101
Denial of service	101
Designated bridge	207
Designated port	207, 212
Destination table	221
Device description language	297
Device Level Ring	191
Device status	224
DHCP	41
DHCP L2 Relay	260
DHCP server	110, 114, 311, 315
Diameter (Spanning Tree)	201
DiffServ	128
Disabled port	208
DLR - EtherNet/IP compatibility	196
DoS	101
DSCP	128, 136
<b>E</b>	
Edge port	207, 212
EDS	279
Engineering Station	303
Engineering system	300
EtherNet/IP website	278
Event log	248
<b>F</b>	
FAQ	343
Fast MRP	168
Faulty device replacement	13
First installation	41
Flow control	139
<b>G</b>	
Gateway	42, 46
Generic Ethernet Module	280
Generic object classes	325
Global Config mode	24
Grandmaster (PTP)	117
GSD	299, 300
GSD file	300
GSDML	297
<b>H</b>	
HaneWin	311, 315
Hardware reset	221
HiDiscovery	41
HiView	56
Host address	42
HSR and PRP network connections (depends on hardware)	187
HSR network structure (depends on hardware)	184
HSR (depends on hardware)	168, 183

<b>I</b>	
IANA	42
IAS	57
Icon	299
IEC 61850	270
IEEE 802.1X	57
IEEE MAC Adresse	242
IGMP snooping	122, 278
Industrial HiVision	11
Instantiation	325
Integrated authentication server	57
IP address	42, 46, 51
IP header	128, 130
ISO/OSI layer model	44
<b>L</b>	
LACNIC	42
Leave message	122
Link Aggration	169
Link monitoring	224, 232
Login dialog	15
Loop guard	213, 215
LRE functionality (depends on hardware)	178
<b>M</b>	
MAC address filter	119
MAC destination address	44
MaxAge	201
Memory (RAM)	69
Message	221
MMS	270
Mode	90
Module properties	301
MRP	168, 170, 171
Multicast	122
<b>N</b>	
Netmask	42, 46
Network load	198, 199
Network management	52
Network management station	303
Network structure (PRP) (depends on hardware)	179
Non-volatile memory (NVM)	69
NVM (non-volatile memory)	69
<b>O</b>	
Object classes	325
Object description	325
Object ID	325
ODVA	278
ODVA website	278
OpenSSH-Suite	19
Operation monitoring	232
Option 82	315
Ordinary clock (PTP)	117

---

<b>P</b>	
Password	18, 20, 22
Path costs	199, 203
PC Worx	300
Polling	221
Port Identifier	199, 200
Port mirroring	251
Port number	200
Port priority	135
Port priority (Spanning Tree)	200
Port roles (RSTP)	207
Port State	208
Priority	130
Priority queue	131
Priority tagged frames	130
Privileged Exec mode	24
PROFIBUS Organization	297
Protection functions (guards)	212
PRP example configuration (depends on hardware)	180
PRP network structure (depends on hardware)	179
PRP RedBox (Example HSR) (depends on hardware)	187
PRP (depends on hardware)	168, 177
PTP	109
PTP domain	118
PuTTY	16
<b>Q</b>	
QoS	129
Query	122

---

<b>R</b>	
RADIUS	57
RAM (memory)	69
Rapid Spanning Tree	168, 169, 207
Real time	128
Reconfiguration	199
Reconfiguration time (MRP)	171
Record	302, 305
RedBox (depends on hardware)	179
Redundancy	198
Reference time source	109, 114, 117
Relay contact	232
Remote diagnostics	232
Report	245
Report message	122
Request Packet Interval	280
RFC	327
Ring	170
Ring manager	170
RIPE NCC	42
RM function	170
RMON probe	251
Root Bridge	203
Root guard	212, 215
Root path	204, 205
Root Path Cost	199
Root port	207, 213
Router	42
Routing Function	279
RPI	280
RS Who	279
RST BPDU	207, 209
RSTP	210

---

<b>S</b>	
SAN (for HSR) (depends on hardware)	184
SAN RedBox (HSR Example) (depends on hardware)	184
Secure shell	16, 19
Segmentation	221
Serial interface	16, 21
Service	245
Service shell	24
Service Shell deactivation	37
Setting the time	109
SFP module	241
Signal contact	232
Simatic S7	300
SNMP	221
SNMP trap	221, 223
SNTP	109
Software version	83
SSH	16, 19
Starting the graphical user interface	15
Store-and-forward	119
STP compatibility	209
STP-BPDU	201
Strict Priority	131
Subidentifier	325
Subnet	46
Symbol	279, 300
System requirements (Graphical User Interface)	15
<b>T</b>	
Tab Completion	34
TCN guard	213, 215
TCP/IP	278, 297
Technical questions	343
Threshold value	299
Topology Change flag	213
ToS	128, 130
Traffic class	131, 136
Traffic shaping	137
Training courses	343
Transmission reliability	221
Transparent clock (PTP)	116
Trap	221, 223
Trap destination table	221
Tree structure (Spanning Tree)	203, 206
TSN	141
Type of Service	130
<b>U</b>	
UDP/IP	278, 297
Update	39
User Exec mode	24
User name	17, 20, 22

---

<b>V</b>	
Video .....	131
VLAN .....	153
VLAN priority .....	135
VLAN tag .....	130, 153
VoIP .....	131
VT100 .....	22
<b>W</b>	
Weighted Fair Queuing .....	131
Weighted Round Robin .....	131





## D Further support

### Technical questions

For technical questions, please contact any Hirschmann dealer in your area or Hirschmann directly.

You find the addresses of our partners on the Internet at [www.hirschmann.com](http://www.hirschmann.com).

A list of local telephone numbers and email addresses for technical support directly from Hirschmann is available at [hirschmann-support.belden.com](http://hirschmann-support.belden.com).

This site also includes a free of charge knowledge base and a software download section.

### Technical Documents

The current manuals and operating instructions for Hirschmann products are available at [doc.hirschmann.com](http://doc.hirschmann.com).

### Hirschmann Competence Center

The Hirschmann Competence Center is ahead of its competitors on three counts with its complete range of innovative services:

- ▶ Consulting incorporates comprehensive technical advice, from system evaluation through network planning to project planning.
- ▶ Training offers you an introduction to the basics, product briefing and user training with certification.  
You find the training courses on technology and products currently available at [www.hicomcenter.com](http://www.hicomcenter.com).
- ▶ Support ranges from the first installation through the standby service to maintenance concepts.

With the Hirschmann Competence Center, you decided against making any compromises. Our client-customized package leaves you free to choose the service components you want to use.

## E Readers' Comments

What is your opinion of this manual? We are constantly striving to provide as comprehensive a description of our product as possible, as well as important information to assist you in the operation of this product. Your comments and suggestions help us to further improve the quality of our documentation.

Your assessment of this manual:

	Very Good	Good	Satisfactory	Mediocre	Poor
Precise description	<input type="radio"/>	<input type="radio"/>	<input type="radio"/>	<input type="radio"/>	<input type="radio"/>
Readability	<input type="radio"/>	<input type="radio"/>	<input type="radio"/>	<input type="radio"/>	<input type="radio"/>
Understandability	<input type="radio"/>	<input type="radio"/>	<input type="radio"/>	<input type="radio"/>	<input type="radio"/>
Examples	<input type="radio"/>	<input type="radio"/>	<input type="radio"/>	<input type="radio"/>	<input type="radio"/>
Structure	<input type="radio"/>	<input type="radio"/>	<input type="radio"/>	<input type="radio"/>	<input type="radio"/>
Comprehensive	<input type="radio"/>	<input type="radio"/>	<input type="radio"/>	<input type="radio"/>	<input type="radio"/>
Graphics	<input type="radio"/>	<input type="radio"/>	<input type="radio"/>	<input type="radio"/>	<input type="radio"/>
Drawings	<input type="radio"/>	<input type="radio"/>	<input type="radio"/>	<input type="radio"/>	<input type="radio"/>
Tables	<input type="radio"/>	<input type="radio"/>	<input type="radio"/>	<input type="radio"/>	<input type="radio"/>

Did you discover any errors in this manual?  
If so, on what page?

---

---

---

---

---

---

---

---

---

---

Suggestions for improvement and additional information:

---

---

---

---

---

General comments:

---

---

---

---

Sender:

---

Company / Department:

---

Name / Telephone number:

---

Street:

---

Zip code / City:

---

E-mail:

---

Date / Signature:

---

Dear User,

Please fill out and return this page

- ▶ as a fax to the number +49 (0)7127/14-1600 or
- ▶ per mail to  
Hirschmann Automation and Control GmbH  
Department 01RD-NT  
Stuttgarter Str. 45-51  
72654 Neckartenzlingen  
Germany



**HIRSCHMANN**

---

A **BELDEN** BRAND